

VICTROLA™

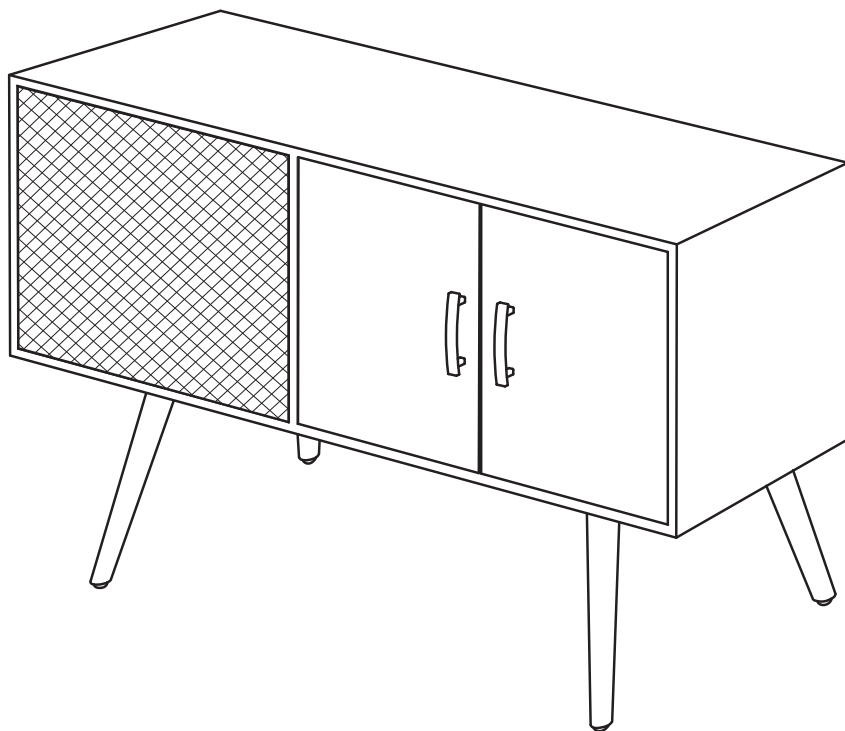

Model: VH-25

WOODLAND
BLUETOOTH SPEAKER CREDENZA

CONTENTS

IMPORTANT SAFETY INSTRUCTIONS.....	2
ACCESSORIES INCLUDED.....	4
ASSEMBLING YOUR FURNITURE	5
INSTALLING THE TIPPING RESTRAINT	7
POWERING THE UNIT.....	8
PRODUCT OVERVIEW	9
LED STATUS.....	10
REMOTE CONTROL	11
GENERAL OPERATIONS.....	12
USB OPERATION.....	13
BLUETOOTH OPERATION.....	13
HDMI OPERATION.....	14
CONNECTING OTHER DEVICES.....	15
AUX-IN OPERATION	15
OPTICAL OPERATION	15
COAXIAL OPERATION.....	15
BLUETOOTH MULTI-PAIR FEATURE	16
SPECIFICATIONS	19
TROUBLESHOOTING GUIDE.....	20

IMPORTANT SAFETY INSTRUCTIONS

1. **Read these instructions** - All the safety and operating instructions should be read before this product is operated.
2. **Keep these instructions** - The safety and operating instructions should be retained for future reference.
3. **Heed all warnings** - All warnings on the appliance and in the operating instructions should be adhered to.
4. Follow all instructions - All operating and use instructions should be followed.
5. Do not use this apparatus near water - The appliance should not be used near water or moisture - for example, in a wet basement or near a swimming pool, and the like.
6. Clean only with a dry cloth.
7. Do not block any ventilation openings. Install in accordance with the manufacturer's instructions.
8. Do not install near any heat sources such as radiators, heat registers, stoves, or other apparatus (including amplifiers) that produce heat.
9. Do not defeat the safety purpose of the polarized or grounding plug. A polarized plug has two blades with one wider than the other. A grounding plug has two blades and a third grounding prong. The wide blade or the third prong is provided for your safety. If the provided plug does not fit into your outlet, consult an electrician for replacement of the obsolete outlet.
10. Protect the power cord from being walked on or pinched particularly at the plugs, convenience receptacles, and at the point where they exit from the apparatus.
11. Only use attachments/accessories specified by the manufacturer.
12. Use only with the cart, stand, tripod, bracket, or table specified by the manufacturer, or sold with the apparatus. When a cart or rack is used, use caution when moving the cart/apparatus combination to avoid injury from tip over.
13. Unplug the apparatus during lightning storms or when unused for long periods of time.
14. Refer all servicing to qualified personnel. Servicing is required when the apparatus has been damaged in any way, such as power supply cord or plug is damaged, liquid has been spilled or objects have fallen into the apparatus, has been exposed to rain or moisture, does not operate normally, or has been dropped.
- 15.



- This lightning flash with arrowhead symbol within an equilateral triangle is intended to alert the user to the presence of non-insulated “dangerous voltage” within the product’s enclosure that may be of sufficient magnitude to constitute a risk of electric shock.

- Warning: To reduce the risk of electric shock, do not remove cover (or back) as there are no user-serviceable parts inside. Refer servicing to qualified personnel.

- The exclamation point within and equilateral triangle is intended to alert the user to the presence of important operating and maintenance instructions in the literature accompanying the appliance.









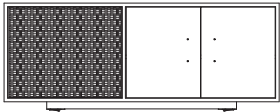

16. The mains plug is used as disconnect device, the disconnect device shall remain readily operable.
17. **CAUTION:** To reduce the risk of fire or electric shock, do not expose this apparatus to rain or moisture. The apparatus shall not be exposed to dripping or splashing and that no objects filled with liquids, such as vases, shall not be placed on apparatus.
18. Use the equipment in a moderate climate.
19. **WARNING:** To prevent electric shock, do not use this (polarized) plug with an extension cord, receptacle or other outlet unless the blades can be fully inserted to prevent blade exposure.

ERP II NOTE (ENERGY RELATED PRODUCTS)

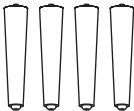
This product complies with the European Commission on the Eco-design directive and its implementing Regulations-Energy related products. 15 minutes (approx.) later without any input (except in FM mode), the system will automatically enter standby mode. Follow the instruction manual to assume the operation.

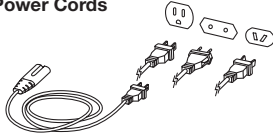
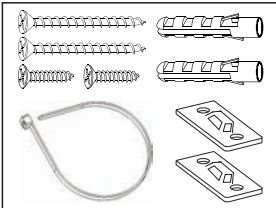
ACCESSORIES INCLUDED

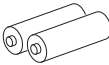
Unpack the box and verify that the following items are included:

<p>A</p>	<p>Main Unit</p> 	<p>X 1</p>	<p>#1</p>	<p>Screws</p> 	<p>X 4</p>
<p>B</p>	<p>Handles</p> 	<p>X 2</p>	<p>#2</p>	<p>Touch-up Pen</p> 	<p>X 1</p>
<p>C</p>	<p>Unit Legs</p> 	<p>X 4</p>	<p>#3</p>	<p>Small Screwdriver</p> 	<p>X 1</p>
<p>* D</p>	<p>Power Cords</p> 	<p>X 3</p>	<p>Tipping Restraint Pack</p>  <p><small>* One set includes 1 safety strap, 2 buckles, 2 rubber stoppers and 4 screws.</small></p>		
<p>E</p>	<p>RCA Cable</p> 	<p>X 1</p>			
<p>F</p>	<p>Remote Control</p> 	<p>X 1</p>			
<p>G</p>	<p>Batteries</p> 	<p>X 2</p>			
<p>H</p>	<p>User Manual (Warranty Card inside)</p> 	<p>X 1</p>			

Note: * D - three power cords with different plugs are included. Depending on your region, select and use the appropriate one.

ASSEMBLING YOUR FURNITURE

IMPORTANT NOTE: Please make sure you have all parts before beginning assembly. Please wait until all steps are completed before tightening bolts. Two people are recommended for assembly.

Step 1: Installing the Handles

Using the included handles, attach the handles into the doors' holes as shown. Tighten two screws (included) from the inside of the doors into the handles' holes. (See picture inset.)

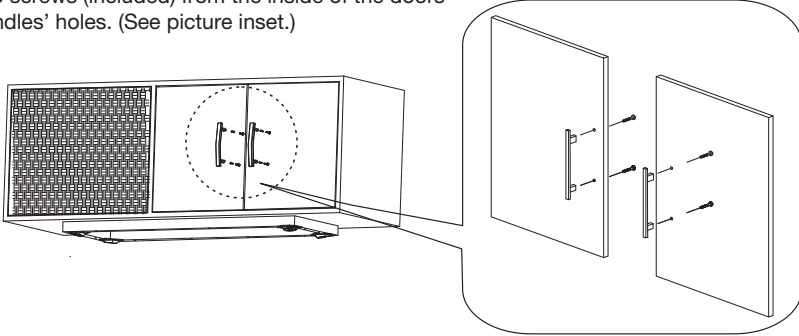

Step 2: Installing the Unit Legs

Lay the unit flat on the floor, face the unit bottom (mounting position) to the side. Then attach the legs (included) to the screw holes at the bottom of the unit and tighten them slowly. Make sure the legs are fixed firmly and place the unit back to the upright position. (See picture inset.)

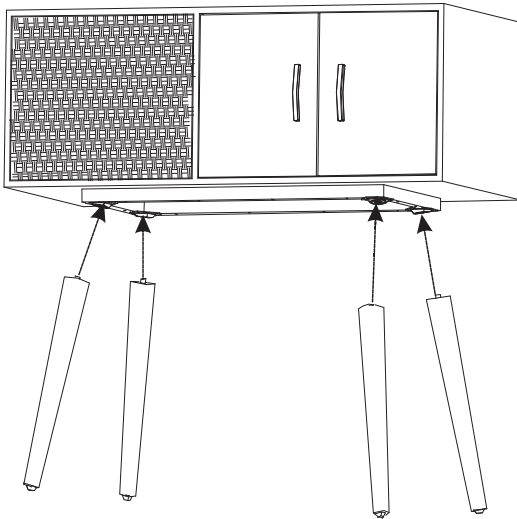

CAUTION: This unit can support a MAXIMUM of 200 lbs once it is assembled. Do not sit or stand on the unit.

Repositioning the Shelf

1. Take out the shelf by removing the screws.
2. Adjust the shelf supports to your preferred position.
3. Put the shelf on the shelf supports and tighten the screws to secure the shelf in place.

Note: Make sure to adjust all 4 of the included shelf supports/screws.

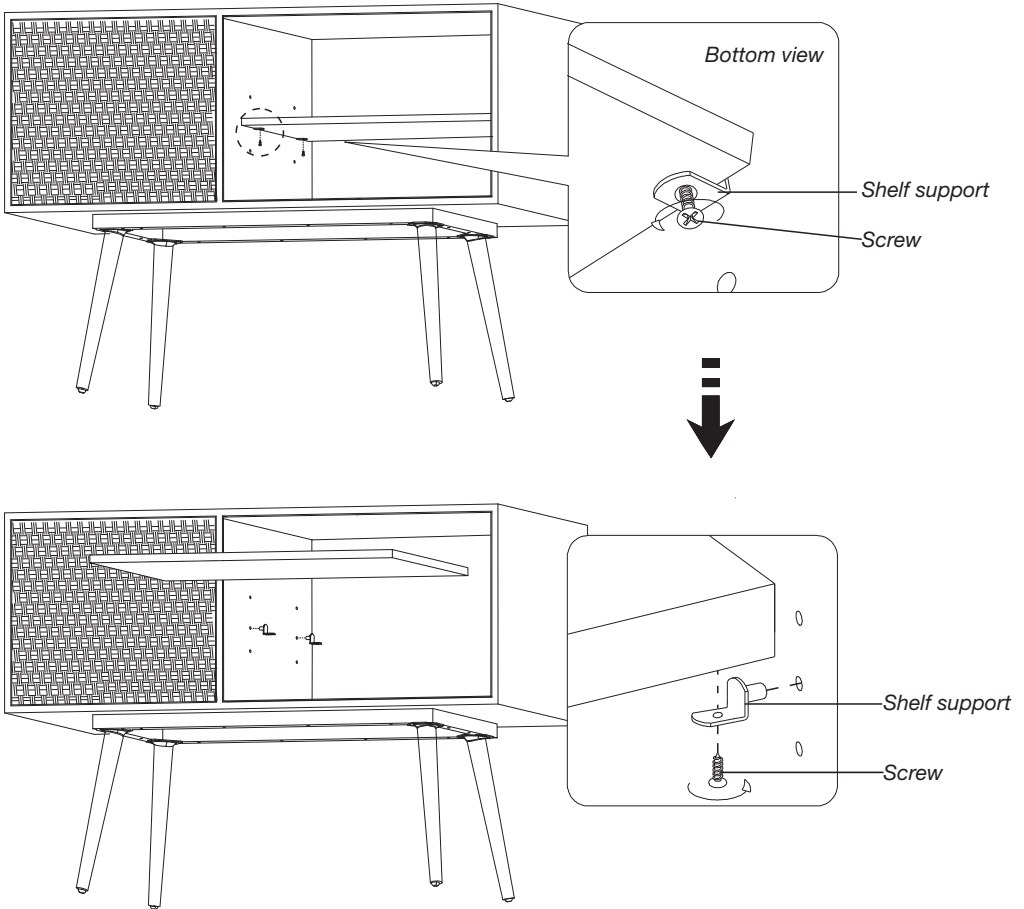

INSTALLING THE TIPPING RESTRAINT

Installing the Tipping Restraint helps to prevent the unit from tipping over.

*** One tipping restraint package includes 1 safety strap, 2 brackets, 2 anchors and 4 screws.**

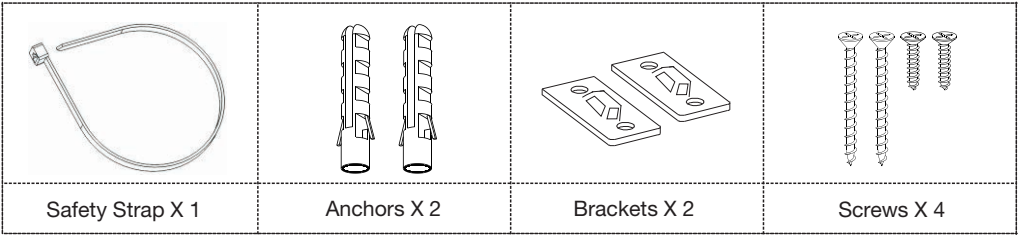

Installing the Tipping Restraint Pack

1. Determine the unit's location in the room.
2. Figure out the placement of the tipping restraint bracket on the wall and mark the screw holes.
3. Use a small drill bit (not included), about 1/16 inch, and drill a small pilot hole to see if there is a stud on the wall. If there is a stud, use the included long screws to attach the bracket to the wall. (If there is no stud in the wall, drill a hole with a larger 1/4 inch drill bit (not included) and install the included anchors.)
4. On the back of the unit, a bracket will need to be attached. To do this, temporarily move the unit to its final position and mark the location of the bracket on the unit.
5. Move the unit away from the wall and drill a pilot hole with a drill bit (not included) about 1/16 inch. Attach the bracket to the unit with the short screws (included).
6. Move the unit into its final position, taking care to line up the wall brackets with the unit brackets. Thread the safety strap (included) through the brackets as shown in picture-6 below. Tighten straps until snug. Do not **overtighten**.
7. Check to be sure that the wall brackets are firmly screwed into the wall, and the unit brackets are firmly attached to the frame, and the straps are snug.

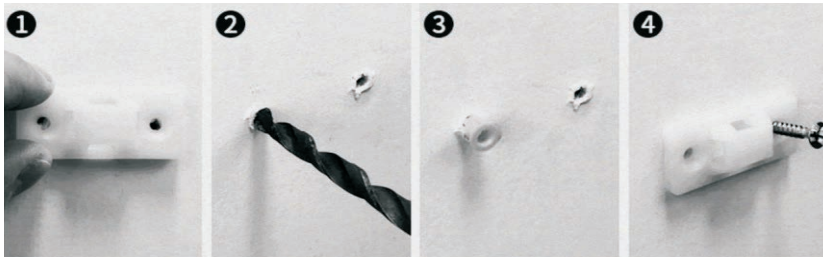

MARK THE WALL

DRILL HOLES

INSTALL ANCHOR

INSTALL SCREW

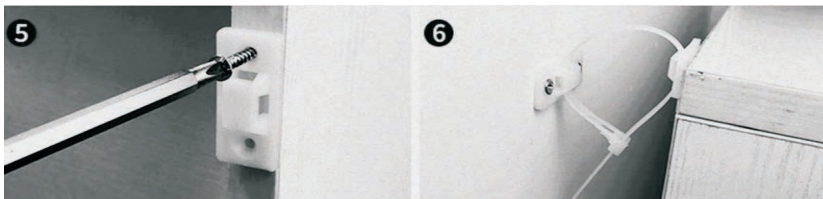

ATTACH BRACKET TO FURNITURE

TIGHTEN STRAPS TO SECURE

POWERING THE UNIT

CAUTION: Only use the AC Power Cords supplied with this device. Do not use a power supply from another device or manufacturer. Using any other power cords or power supply may cause damage to the device and void your warranty.

1. Insert the AC Power Cord (included) into the AC INLET (AC IN) of the unit.
2. Connect the correct power cord to the wall socket.

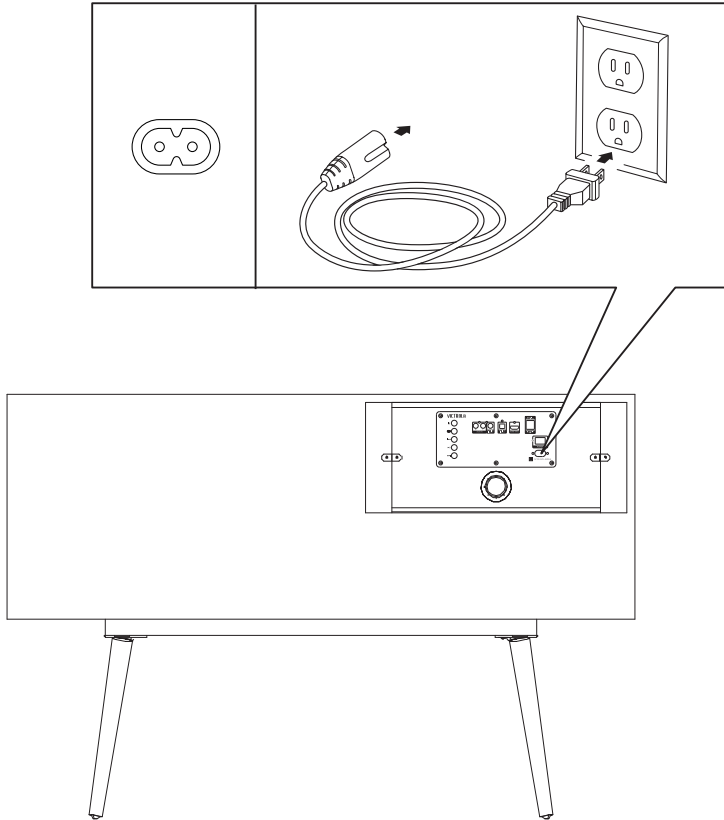

NOTE:

Three power cords with different plugs are included. Depending on your region, select and use the appropriate one.

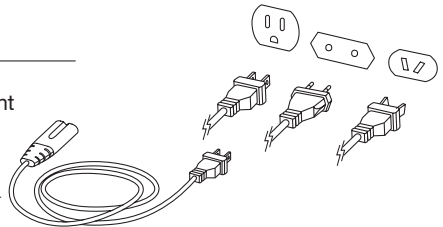

PRODUCT OVERVIEW

Control Panel

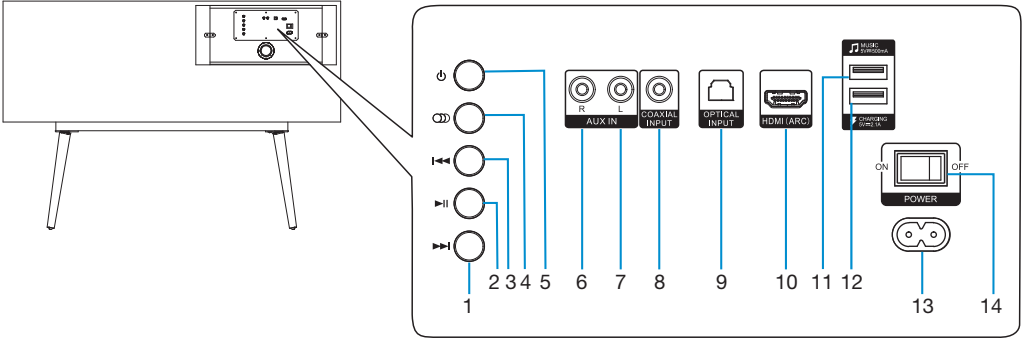

1. NEXT

- Press to go to the next track.
Note: Function only supports Bluetooth and USB modes.
- **Hold the button for 3-5 seconds to increase the volume level.**

2. PLAY/PAUSE, PAIR

- Press once to pause the playback, press again to resume.
Note: Function only supports Bluetooth and USB modes.
- In Bluetooth mode, hold the button for 3-5 seconds to disconnect the Bluetooth connection. Press the button again to reconnect.
Note: The reconnect function only supports the devices that connected with the unit before.

3. PREVIOUS

- Press to go to the previous track.
Note: Function only supports Bluetooth and USB modes.
- **Hold the button for 3-5 seconds to decrease the volume level.**

4. MODE/SOURCE

- Press the button repeatedly to switch to a different playback mode.
- Hold the button for 3-5 seconds to set as an additional unit. (*Bluetooth Multi-Pair mode only*)

5. STANDBY/ON-OFF

- Turn ON the unit or switch the unit to Standby mode.
- Hold the button for 3-5 seconds to set as the primary unit. (*Bluetooth Multi-Pair mode only*)

6. AUX-IN JACK (R) / 7. AUX IN JACK (L)

- Use to connect devices with an RCA cable (included).

8. COAXIAL-IN CONNECTOR

- Connect to the coaxial digital out device with a coaxial cable (not included).

9. OPTICAL-IN CONNECTOR

- Connect to the optical digital out device with an optical cable (not included).

10. HDMI (ARC) CONNECTOR

- Used to connect to the TV or HDMI equipment with an HDMI cable (not included).

11. USB PLAYBACK PORT

- Connect USB storage devices.
Note: The maximum USB memory size is 32GB.

12. USB CHARGING PORT

- Use to charge your device with a USB cable.

13. AC INLET (AC IN)

- Used to connect the power cord (included).
Note: Three power cords with different plugs are included. Depending on your region, select and use the appropriate one.

14. POWER SWITCH

- Used to power ON or OFF the unit.

LED STATUS

Status LED Indicators

(Hidden behind speaker grill)

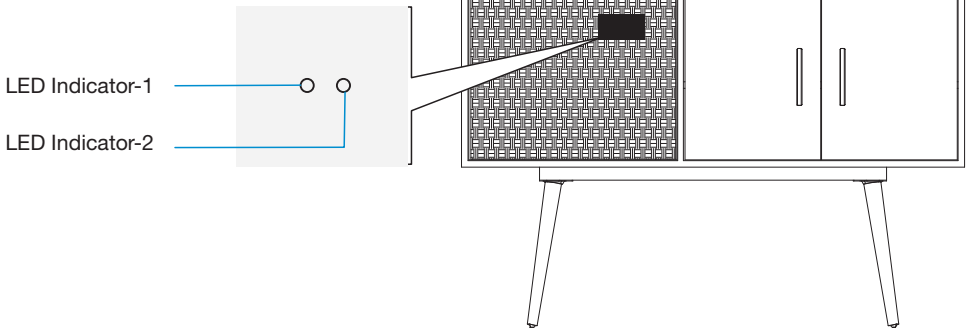

Standard LED Status

Device Operation Mode	LED Indicator-1 Action	LED Indicator-2 Action
Standby Mode	RED (solid)	–
Bluetooth Mode	Searching/Pairing: BLUE (blinks slowly)	–
	Connected: BLUE (solid)	–
AUX-IN Mode	–	ORANGE (solid)
Optical Input Mode	–	WHITE (solid)
Coaxial Input Mode	RED (solid)	WHITE (solid)
HDMI (ARC) Mode	PURPLE (solid)	–
USB Playback Mode	BLUE (solid)	ORANGE (solid)

Note:

- The LED Indicator-1 & 2 will have different actions in Bluetooth Multi-Pair Feature. (See Page 15).
- The Indicators on the front of the unit will approximately stay on for 10 seconds. Press any button on the unit or remote control to activate the LED.

REMOTE CONTROL

Button Function

1. STANDBY/ON-OFF

- Turn ON the unit or switch the unit to Standby mode.
- Hold the button for 3-5 seconds to set as the Primary unit.
(Bluetooth Multi-Pair mode only)

2. MUTE

- Press **Once** to cut the playing volume in half.
- Press **Twice** to mute sound completely.
- Press a **Third time** to resume playing volume.

3. PREVIOUS / 7. NEXT

- Go to the previous/next track.
Note: Function only supports Bluetooth and USB modes.

4. PLAY/PAUSE, PAIR

- Press once to pause the playback, press again to resume.
Note: Function only supports Bluetooth and USB modes.
- In Bluetooth mode, hold the button for 3-5 seconds to disconnect the Bluetooth connection. Press the button again to reconnect.
Note: The reconnect function only supports the devices connected with the unit previously.

5. VOLUME+ / 6. VOLUME-

- Increase/decrease the volume level.

8. NORMAL / 9. ROCK / 11. JAZZ / 12. POP

- Adjust the sound effect.

10. MODE

- Press button repeatedly to switch to different playback modes.

13. REACTION INDICATOR

- The indicator will flash red when pressing any buttons on the remote control.

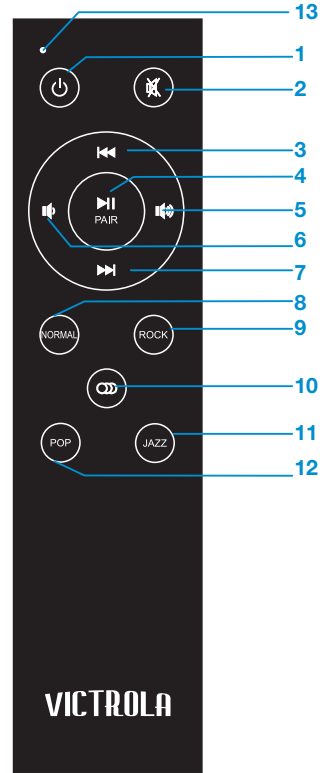

Remote Control Operation

When the distance required for operation between the remote control and the unit decreases, it is necessary to replace the batteries with new ones. The remote control is powered by 2 AAA batteries. To replace the batteries, remove the battery cover on the back of the remote and remove the old batteries. Replace with two new batteries according to the indicated polarity. Place the battery cover back on the remote.

Battery Precautions

- Be sure to insert the batteries with correct positive “+” and negative “-” orientation. ALWAYS use batteries of the same type. Never mix different types of batteries together.
- When using rechargeable batteries, refer to the precautions on their labels.
- When the remote control unit is not to be used for extended periods of time (more than a month), remove the batteries to prevent them from leaking.
- Do not heat or disassemble batteries, and NEVER dispose of old batteries by throwing them in a fire.
- Do not dispose of device into standard garbage disposal sites. Dispose of device at available Battery Recycling Sites after fully discharging battery. Not doing so may violate disposal laws and regulations.
- Please refer to local regulations for proper battery disposal.

GENERAL OPERATIONS

POWER ON THE DEVICE

Select an appropriate power cord (included) and plug it into the **AC INLET (AC IN)**. Switch the **POWER SWITCH** to **ON**. It is strongly recommended that this product should be operated only from the type of power source marked on the rating label.

STANDBY

Press the **STANDBY/ON-OFF** button on the panel or remote control to turn on the unit or enter Standby mode.

MODE

Repeatedly press the **MODE** button on the panel or remote control to change the playback modes: Bluetooth, AUX-IN, Optical Input, Coaxial Input, HDMI (ARC) and USB Playback.

VOLUME+ & VOLUME-

Press the **VOLUME+** or **VOLUME-** button on remote control to increase or decrease the volume level.
Note: *There will be a chime when the volume reaches the maximum or minimum level.*

MUTE

During playback, press the **MUTE** button on the remote control *once* and the volume will be cut in half. Press *twice* to mute the sound. Press a *third time* to resume volume.

PLAY/PAUSE, PAIR

1. When playing in Bluetooth or USB mode, press the **PLAY/PAUSE/PAIR** button on the panel or remote control to pause the playback, press again to resume.
2. In Bluetooth mode, hold the **PLAY/PAUSE/PAIR** button for 3-5 seconds to disconnect the Bluetooth connection. Press the button again to reconnect.

Note: *The reconnect function only supports the devices that were connected with the unit prior.*

PREVIOUS & NEXT

When playing in Bluetooth or USB mode, press **PREVIOUS** or **NEXT** button on the panel or remote control to skip to the next track or previous.

EQ FUNCTION (NORMAL / ROCK / POP / JAZZ)

Press the **NORMAL**, **ROCK**, **POP** or **JAZZ** button on remote control to adjust the sound effect.

IMPORTANT NOTES: *The unit will auto switch to your last playback mode and settings when turned on the next time.*

USB OPERATION

USB Playback:

1. Press the **MODE** button on the panel or remote control to enter **USB** mode. Once entered, the **LED Indicator-1** will be lit up in solid Blue and the **LED Indicator-2** will be lit up in solid Orange at the same time.
2. Plug the USB memory stick (not included) into the **USB PLAYBACK PORT** on the unit. It will detect and playback automatically.
3. Control the playback from the unit or remote. Now you can enjoy the music from your USB.

Note:

- The maximum recommended USB memory size is 32GB.
- USB playback supports MP3 and WMA file formats.

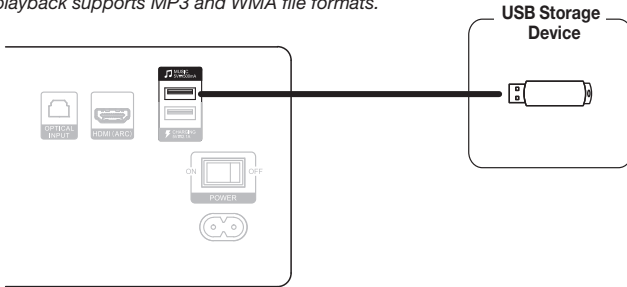

USB Charging:

In any mode, you can charge your device via the **USB CHARGING PORT**.

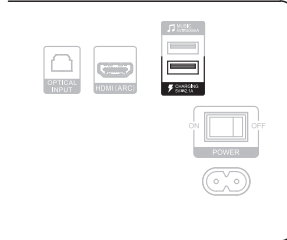

BLUETOOTH OPERATION

1. Press the **MODE** button on the panel or remote control to enter Bluetooth mode. Once in Bluetooth mode, the **LED Indicator-1** will slowly blink blue
2. Go to Bluetooth settings on your device. Make sure your device's Bluetooth feature is ON.
3. From the Bluetooth list on your device, select **< VH-25 >**. Once successfully connected, a chime will be heard, and the **LED Indicator-1** will stop blinking and be solid blue.
Notes: In some cases, password is required for your devices, input "0000" to connect.
4. Play the audio on your device, you will now hear audio from the unit.
 - a. To disconnect the Bluetooth connection, hold the **PLAY/PAUSE/PAIR** button for 3-5 seconds, or press the **MODE** button to switch to another mode, or deactivate the Bluetooth function from your device directly.
 - b. To reconnect, press the **PLAY/PAUSE/PAIR** button again. After successfully reconnecting, press the button one more time to start the playback.

Note:

- The unit only reconnects to devices that were successfully connected before.
- Before reconnecting, please ensure there is no other Bluetooth connection to the unit.

HDMI OPERATION

HDMI (ARC)

The **ARC (Audio Return Channel) function** allows you to send audio from your ARC-compliant TV to your unit through a single HDMI connection. To use the ARC function, please ensure your TV is ARC compliant and set up accordingly. The setting method of ARC may differ depending on your TV model. For details regarding the ARC function, please refer to your TV owner's manual.

Using HDMI (ARC)

1. Connect the HDMI cable (not included) from the HDMI ARC port of this unit to the HDMI ARC port on your ARC compliant TV.
2. Ensure the unit is powered on. Press the **MODE** button repeatedly on the remote control or the unit itself until the LED indicator-1 is lit up Purple.
3. Once successfully connected, the sound from your TV can be played directly from the unit.

Note:

- Only V1.4 or V2.0 version for the HDMI Cable can be used for this unit.
- Your TV needs to be compatible with the ARC function.

IMPORTANT: While in HDMI (ARC) mode, if there is no sound output, you may need to activate PCM output on your source device (eg. TV, DVD, or Blu-ray player). Please refer to your source device's owner's manual for activating PCM.

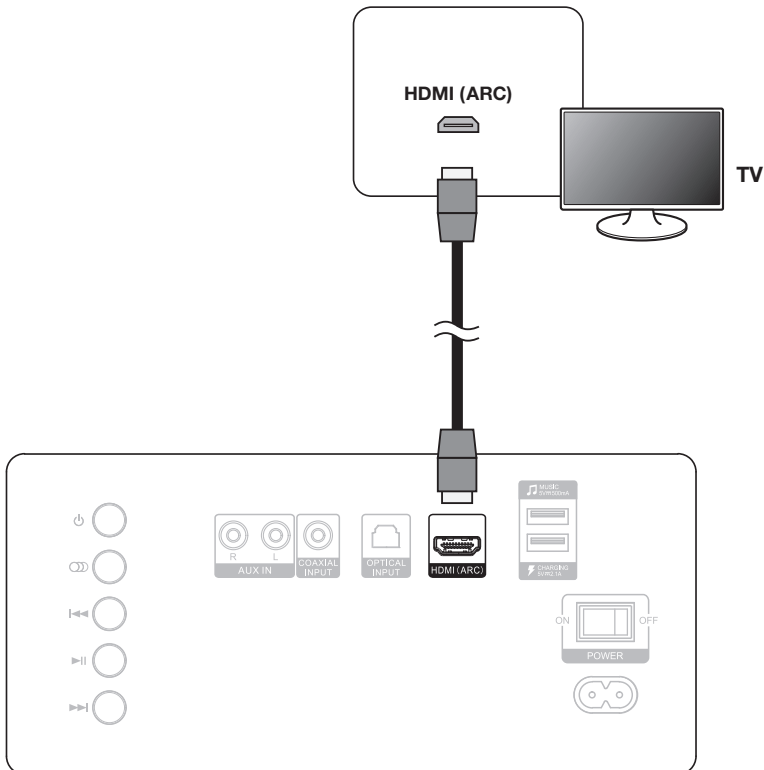

CONNECTING OTHER DEVICES

Connecting an audio playback device

Connect to COAXIAL-IN, OPTICAL-IN or AUX-IN input to an audio playback device (CD player, portable music player, etc.) using the appropriate cables.

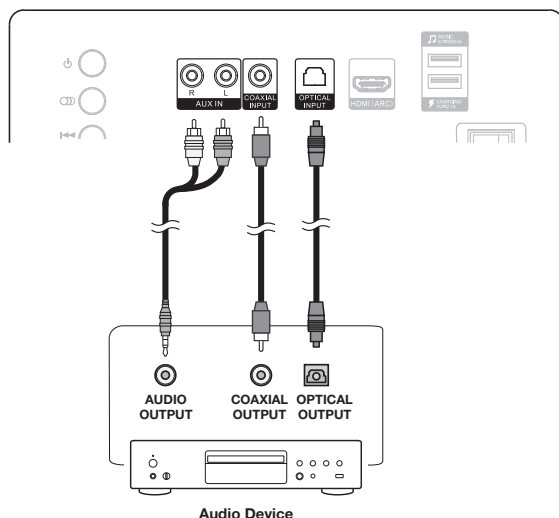

AUX-IN OPERATION

1. Press the **MODE** button on the panel or remote control to enter **AUX-IN** mode. Once entered, the **LED Indicator-2** will be lit up in a solid Orange color.
2. Connect the unit with an RCA cable (included). Make sure it is White to White and Red to Red. Then connect the other end of the cable to your device.
3. Control the playback from your device.

OPTICAL OPERATION

1. Press the **MODE** button on back panel or remote control to enter **OPTICAL** Input mode. Once entered, the **LED Indicator-2** will be lit up in a solid White color.
2. Use a digital optical cable (not included) to connect your television's optical digital output to the unit's **OPTICAL INPUT CONNECTOR**.
3. Other components connected to the television, such as a DVD/Blu-ray player or cable/satellite tuner, will automatically play through the unit.

COAXIAL OPERATION

1. Press the **MODE** button on back panel or remote control to enter **COAXIAL** Input mode. Once entered, the **LED Indicator-1** will be lit in a solid Red and **LED Indicator-2** in solid White at the same time.
2. Use an "RCA"-type cable (not included) to connect your television's coaxial digital audio output to the unit's **COAXIAL INPUT CONNECTOR**.
3. Other components connected to the television, such as a DVD/Blu-ray player or cable/satellite tuner will automatically play through the unit.

BLUETOOTH MULTI-PAIR FEATURE

This unit can pair with over 8 Victrola furniture pieces simultaneously for total surround sound.

How to Set Up Two Or More Units with the Bluetooth Multi-Pair Feature:

1. Power on only one unit (*The unit you want to set as your primary*).
2. Hold the **STANDBY/ON-OFF** button on one of the speakers for 3-5 seconds to set it as the primary unit. The two indicators on the primary unit will be with different actions in different playback modes when successfully set.

Device Operation Mode	LED Indicator-1 Action	LED Indicator-2 Action
Bluetooth Mode	<i>BLUE (blinks slowly)</i>	<i>WHITE (blinks slowly)</i>
AUX-IN Mode	–	<i>ORANGE (blinks slowly)</i>
Optical Input Mode	–	<i>WHITE (blinks slowly)</i>
Coaxial Input Mode	<i>RED (blinks slowly)</i>	<i>WHITE (blinks slowly)</i>
HDMI (ARC) Mode	<i>PURPLE (blinks slowly)</i>	–
USB Playback Mode	<i>BLUE (blinks slowly)</i>	<i>ORANGE (blinks slowly)</i>

Note: You can only set one primary unit.

3. Set other speakers as Additional units, one by one:
 - a. Switch the Additional unit to **Bluetooth Mode**.
 - b. Press and hold the **MODE** button for 3-5 seconds to set it as the Additional unit.
(*LED Indicator-1 blinks quickly in Blue and LED Indicator-2 blinks quickly in White).
It will search and pair with the primary unit automatically.
 - c. Once successfully paired, the two indicators on the additional unit will stop blinking and steadily light up.
 - d. Repeat **Step-a** to **Step-c** if you want to pair additional units.
4. After completing Step 3, select and operate playback modes from the primary unit, and the music will be synchronized to all the additional speakers.

Note:

- The Additional unit only can be set in Bluetooth mode. Once switched to other modes, it will be disconnected from the primary unit and quit the Bluetooth Multi-Pair Feature automatically.
- If there is static/interference during playback, we suggest to have a distance of 2-3 meters between units to avoid interference.

How to Disconnect:

1. Press and hold the **STANDBY/ON-OFF** button on the primary unit for 3-5 seconds to cancel the Bluetooth Multi-Pair settings. It will switch back to the normal playback mode automatically.
2. Press and hold the **MODE** button on the additional units for 3-5 seconds to cancel the additional speaker setting. Or you can press the **MODE** button directly to quit Bluetooth status and switch to another audio mode.
3. At this time, you can reset the Bluetooth Multi-Pair Feature when connecting the units.

Note: The Bluetooth Multi-Pair settings will be saved and paired to each other automatically when you turn on the unit the next time. Before reset, you must cancel the original setting first.

Operation Mode While Using Bluetooth Multi-Pair:

(Make sure to set your primary and secondary units **FIRST!** See page 16)

IMPORTANT:

- *The mode can only be switched on the primary unit. If you change the mode on the additional unit, the Bluetooth Multi-Pair connection on the additional unit will be disconnected automatically.*
- *The volume level for the primary and additional unit is independently controlled. They need to be adjusted separately. (Use a remote control directed at the primary unit to adjust volume. Then use the same remote and point to each additional unit to adjust the volume.)*
- *To mute the sound for both the primary and additional units, press the **MUTE** button twice on the remote facing the primary unit. (Press once to reduce the primary unit volume by half, while the additional unit volume will stay unchanged.) If you press the **MUTE** button with the remote facing the additional unit, only the additional unit will be muted by half and the primary unit will be unchanged.*
- *In Bluetooth and USB modes, press the **PLAY/PAUSE** button to pause or play both the primary and additional units.*
- *In AUX-IN, Optical, Coaxial and HDMI modes, the **PLAY/PAUSE** and **PREVIOUS/NEXT** buttons have no functions.*
- *Change the volume effect by activating the EQ function of the primary unit (press the **NORMAL**, **ROCK**, **POP** or **JAZZ** button on the remote control facing the primary unit). The sound effect for the additional units will be synchronized with the primary unit.*

BLUETOOTH OPERATION:

1. Press the **MODE** button of the primary unit to enter Bluetooth Mode, when in Bluetooth pairing status, you can see the blue and white LED indicators on the primary unit will light up and start blinking.
2. You can now search for the Primary unit (**VH-25**) using your external Bluetooth device. Once the device is found, pair with the (**VH-25**).
3. Once the device is paired, an audible tone will sound from the Master unit.
4. Play audio from your Bluetooth device. Volume can be controlled on your source device and the speakers. Once playing, the music will be synchronized with the additional units.

USB OPERATION:

1. Press the **MODE** button on the primary unit to enter USB playback mode, and the blue and orange LED indicators on the primary unit will light up and start blinking.
2. Plug a USB memory stick (not included) into the **USB PLAYBACK PORT** of the primary unit, and it will start to play the music from the USB automatically on the primary and the additional units at the same time.
3. Control the playback on the primary unit.

AUX-IN OPERATION:

1. Press the **MODE** button of the primary unit to enter AUX-IN Mode. The orange LED indicator on the primary unit will light up and start blinking.
2. Connect an RCA audio cable to the primary unit.
3. Start and control the playback from your device or the primary unit. The music on the additional units will be synchronized with the primary unit.

OPTICAL OPERATION:

1. Press the **MODE** button of the primary unit to enter Optical Mode. The white LED indicator on the primary unit will light up and start blinking.
2. Use a digital optical cable (not included) to connect your television's optical digital output to the **OPTICAL INPUT JACK** on the primary unit. Other components connected to the television, such as a DVD/Blu-ray player or cable/satellite tuner, will automatically play through the primary and additional units at the same time.

COAXIAL OPERATION:

1. Press the **MODE** button of the primary unit to enter Coaxial Mode. The red and white LED indicators on the Primary unit will light up and start blinking.
2. Connect an "RCA"-type cable (not included) to connect your television and the primary unit.
3. Other components connected to the television, such as a DVD/Blu-ray player or cable/satellite tuner, will automatically play through the primary unit and the additional units.

HDMI OPERATION:

1. Press the **MODE** button of the primary unit to enter HDMI Mode. The purple LED indicator on the primary unit will light up and start blinking.
2. Connect your television and the primary unit with an HDMI Cable (not included).
3. Once successfully connected, the primary unit and additional units will start playing at the same time.
4. Control the playback on the primary unit.

BLUETOOTH MULTI-PAIR TROUBLESHOOTING:

- If you are having trouble pairing multiple pieces of furniture together, follow the easy troubleshooting steps below:

1. Turn off your Bluetooth settings on any external devices and forget any previous paired Victrola furniture devices.
2. Turn off all pieces of furniture.
3. Turn on the unit that will be the primary unit.
4. Go to Bluetooth mode on the furniture. If a single Blue LED is flashing, follow the instructions on page 16.
5. If there are two LED's lit and flashing (blue and white), then press and hold the **Standby** button for three seconds, until only one blue LED remains lit.
6. If there are still two lights lit, press and hold the **Source** button for 3 seconds.
Once the blue LED is blinking by itself, proceed to normal pairing steps on page 16.
**Follow the above steps 1-6 on each piece of furniture that was not connecting properly.*

Note: *If you have multiple units (multiple remotes) - one remote can be used to control all Victrola Furniture pieces. Just point directly at the preferred unit to adjust settings.*

SPECIFICATIONS

GENERAL

Power Requirements.....	AC 100-240V~50/60Hz
Power Consumption	80W
Unit Dimensions	47.25W x 15.7D x 30.6H (inches)
.....	1,200W x 399D x 777H (mm)
Unit Weight	90.39 lbs (41 kg)
	(Max. supported weight: 200 lbs)

AMPLIFIER

Output Power.....	2 x 20W + 40W
Frequency Response Subwoofer.....	20 to 200 Hz
.....	Mid-range tweeter:
	200 Hz to 20 KHz

SPEAKER SYSTEM

Type	2.1ch
Impedance	4 Ohms

USB

USB Playback	5V, 500mA
USB Charging	5V, 2.1A

BLUETOOTH

Bluetooth Version.....	Bluetooth V4.0
Bluetooth Profiles.....	A2DP, AVRCP
Bluetooth Frequency Range	2,402GHz - 2,480GHz
Operation Distance	33 feet (10 meters)

TROUBLESHOOTING GUIDE

	Symptom	Possible Cause	Solution
GENERAL	• Unit will not power on.	• Unit is unplugged.	• Connect the unit to the AC power supply.
	• Unit will not turn on.	• Power switch is not turned on.	• Turn the power switch to On.
	• No sound output from speakers.	<ul style="list-style-type: none"> • The volume level is set too low. • Mute the sound. • The input selector does not match the playback source. 	<ul style="list-style-type: none"> • Adjust the volume. • Cancel the mute function. • Select the correct input source.
	• Noise / Distortion in sound output.	• The unit is too close to another interfering device.	• Turn off the other appliance, and relocate the unit.
	• Unit fails to respond.	• It might result from external factors such as ESD (Electro-static discharge).	• Disconnect the power cord and external audio device. Re-plug in the power cord after one minute.
	BLUETOOTH	• No sound	<ul style="list-style-type: none"> • The unit is not switched to Bluetooth Mode. • Your device's and/or the unit's volume is not turn on. • Your device is too far from the unit or there is some obstacle between your device and the unit.
• Sound has a lot of static		• Your device is too far away	• Bring your device closer to the unit.
• Unable to pair with a Bluetooth device.		<ul style="list-style-type: none"> • Your device doesn't have Bluetooth connectivity. • The Bluetooth pairing is not successful. 	<ul style="list-style-type: none"> • Confirm that your device is Bluetooth compatible. • Confirm that the unit is not paired with another device. • Re-pair the unit and device again.
BLUETOOTH MULTIPAIR	• Cannot use the Multi-Pair connecting function.	• The primary / additional unit hasn't been set, or unsuccessful set.	<ul style="list-style-type: none"> • Make sure to cancel the BT Multi-Pair connection before setting. • Make sure the additional unit is set in Bluetooth Mode.

For future assistance with your product, call Victrola at TOLL FREE# 1-877-ITECH-97 (1-877-483-2497).

Please note: As a result of continual improvements, the design and specifications of this product are subject to change without notice.

Made in China.

Bluetooth is a registered trademark of Bluetooth SIG, Inc. Other trademark and track name are those of their respective owners.

FCC Statement

Warning: Changes or modifications to this unit not expressly approved by the party responsible for compliance could void the user authority to operate the equipment.

NOTE: This equipment has been tested and found to comply with the limits for Class B digital device, pursuant to part 15 of the FCC Rules. These limits are designed to provide reasonable protection against harmful interference in a residential installation. This equipment generates, uses and can radiate radio frequency energy and, if not installed and used in accordance with the instructions, may cause harmful interference to radio communications. However, there is no guarantee that interference will not occur in a particular installation. If this equipment does cause harmful interference to radio or television reception, which can be determined by turning the equipment off and on, the user is encouraged to try to correct the interference by one or more of the following measures:

- Reorient or relocate the receiving antenna.
- Increase the separation between the equipment and the receiver.
- Connect the equipment into an outlet on a circuit different from that to which the receiver is connected.
- Consult the dealer or an experienced radio/TV technician for help.

This device complies with Part 15 of the FCC Rules. Operation is subject to the following two conditions: (1) This device may not cause harmful interference, and (2) this device must accept any interference received, including interference that may cause undesired operation.

FCC Radiation Exposure Statement This equipment complies with FCC/IC radiation exposure limits set forth for an uncontrolled environment. This equipment should be installed and operated with minimum distance 20cm between the radiator & your body.

CALIFORNIA PROP 65 WARNING



WARNING: This product can expose you to chemicals including lead, which is known to the State of California to cause cancer and birth defects or other reproductive harm.

For more information go to www.P65Warnings.ca.gov.

IC WARNING

-English:

This device contains license-exempt transmitter(s)/receiver(s) that comply with Innovation, Science and Economic Development Canada's license-exempt RSS(s). Operation is subject to the following two conditions:

- (1) This device may not cause interference, and
- (2) This device must accept any interference, including interference that may cause undesired operation of the device.

-French:

Cet appareil contient des émetteurs / récepteurs exemptés de licence conformes aux RSS (RSS) d'Innovation, Sciences et Développement économique Canada. L'exploitation est autorisée aux deux conditions suivantes:

- (1) l'appareil ne doit pas produire de brouillage, et
- (2) l'utilisateur de l'appareil doit accepter tout brouillage radioélectrique subi, même si le brouillage est susceptible d'en compromettre le fonctionnement.

Victrola is a registered trademark of Innovative Technology Electronics LLC.

Innovative Technology Electronics LLC.

Limited Warranty: 90 Days Labor, One Year Parts

Innovative Technology Electronics LLC. (IT) warrants the product to be free from “Defects” in materials under normal use for a period of “One Year” from the date of the original purchase. The Warranty is “Not” transferable. IT agrees, within the initial “90 Day” period, to repair or replace the product if it is determined to be defective at “No Charge”. It is further agreed that IT will cover the cost to repair or replace damaged “Parts” only for a total period of “One Year” from the date of the original purchase. The warranty does not cover cosmetic damage, antennas, AC cords, cabinets, headbands, ear-pads, or damage due to line power surges, connection to improper voltage supply or settings, misuse, mishandling, accident, acts of God or attempted repair by an unauthorized service agent.

To obtain service, the purchaser MUST present an original sales receipt / proof of purchase. Please contact us at www.victrola.com to request an RMA (Return Material Authorization) number to return products for service or replacement. Returns without an RMA number on the package will be refused and returned to sender. Upon receipt of the returning item and our full inspection (IT) may issue a replacement to customer for the same item or of one that has equivalent value and features. To return an item, supply full name, return address, phone number, item purchased, receipt of purchase and reason for return to obtain RMA number.

All returns must be in the original packaging or reasonable substitute to prevent damage. Customer “Must” include full name, shipping address and telephone number inside of package. No return will be shipped back to a PO Box or APO address.

Please include your check or money order in the amount of:

- **USD \$5.00 for items \$10.00 to \$39.99. (Price Paid Per Unit)**
- **USD \$10.00 for items \$40.00 to \$99.99. (Price Paid Per Unit)**
- **USD \$16.00 for items \$100.00 and up. (Price Paid Per Unit)**
- **Shipping fees are non-refundable.**

to be payable to Innovative Technology Electronics LLC. (for handling and return shipping charges) (IT) will not be responsible for delays or unprocessed claims resulting from a purchaser’s failure to provide any / all of the necessary information. Send all inquiries or RMA request via our website

www.victrola.com/pages/technical-support.

Innovative Technology Electronics LLC.

1 Channel Drive

Port Washington, NY 11050

Toll free: 1-877-483-2497

Website for support: www.victrola.com/pages/technical-support

There are no express warranties except as listed above.

REPAIR OR REPLACEMENT AS PROVIDED UNDER THIS WARRANTY IS THE EXCLUSIVE REMEDY OF THE CUSTOMER, (IT) SHALL NOT BE LIABLE FOR ANY INCIDENTAL OR CONSEQUENTIAL DAMAGES FOR BREACH OF ANY EXPRESS OR IMPLIED WARRANTY ON THIS PRODUCT EXCEPT TO THE EXTENT PROHIBITED BY APPLICABLE LAW. ANY IMPLIED WARRANTY OF MERCHANTABILITY OR FITNESS FOR A PARTICULAR PURPOSE ON THIS PRODUCT IS LIMITED IN DURATION TO THE DURATION OF THIS WARRANTY.

Some states do not allow the exclusion or limitation of incidental or consequential damages, or limitations on how long an implied warranty lasts, so the above exclusions or limitations may not apply to you. This warranty gives you specific legal rights and you may also have other rights, which vary from state to state.