



# Bluetooth Tower Speaker

MODEL: ITSB-105



## Instruction Manual

PLEASE READ CAREFULLY BEFORE OPERATING THIS EQUIPMENT.  
KEEP IT IN A SAFE PLACE FOR FUTURE REFERENCE.

## IMPORTANT SAFETY INSTRUCTIONS



### CAUTION

RISK OF ELECTRIC SHOCK  
DO NOT OPEN



CAUTION: TO REDUCE THE RISK OF ELECTRIC SHOCK, DO NOT REMOVE THE COVER (OR BACK). NO USER SERVICEABLE PART INSIDE, REFER SERVICING TO QUALIFIED SERVICE PERSONNEL.



**DANGEROUS VOLTAGE:** The lightning flash with arrowhead symbol within an equilateral triangle is intended to alert the user to the presence of uninsulated “dangerous voltage” within the product’s enclosure that may be of sufficient magnitude to constitute a risk of electric shock to persons.



**ATTENTION:** The exclamation point within an equilateral triangle is intended to alert the user to the presence of important operating and maintenance (servicing) instructions in the literature accompanying the appliance.

**WARNING: TO PREVENT FIRE OR SHOCK HAZARD, DO NOT EXPOSE THIS UNIT TO RAIN OR MOISTURE.**

### **WARNING: USE UNDER SUPERVISION OF AN ADULT DUE TO LONG CORD**

This unit has a long cord that can be easily tripped on or pulled on, causing injury. Please make sure it is arranged so that it will not drape over a tabletop, etc. Where it can be pulled on by children or tripped over accidentally.

### **FCC NOTICE:**

This equipment has been tested and found to comply with the limits for a Class B digital device, pursuant to Part 15 of the FCC Rules. These limits are designed to provide reasonable protection against harmful interference in a residential installation. This equipment generates, uses and can radiate radio frequency energy and, if not installed and used in accordance with the instructions, may cause harmful interference to radio communications. However, there is no guarantee that interference will not occur in a particular installation. If this equipment does cause harmful interference to radio or television reception, which can be determined by turning the equipment off and on, the user is encouraged to try to correct the interference by one or more of the following measures:

- Reorient or relocate the receiving antenna.
- Increase the separation between the equipment and receiver.
- Connect the equipment into an outlet on a circuit different from that to which the receiver is connected.
- Consult the dealer or an experienced radio / TV technician for help.

**FCC STATEMENT:**

This device complies with part 15 of the FCC Rules. Operation is subject to the following two conditions:

- (1) This device may not cause harmful interference, and
- (2) This device must accept any interference received, including interference that may cause undesired operation. The antenna(s) used for this transmitter must be installed to provide a separation distance of at least 20 cm from all persons and must not be co-located or operating in conjunction with any other antenna or transmitter.

**FCC WARNING:**

To assure continued operation, follow the attached installation instructions and use only shield cables when connecting to other devices. Changes or modifications not expressly approved by the party responsible for compliance could void the user's authority to operate the equipment.

**SAFETY INSTRUCTIONS:**

Before using the unit, be sure to read all operating instruction carefully, please note that these are general precautions and may not pertain to your unit. For example, this unit may not have the capability to be connected to an outdoor antenna.

1. **Read these instructions**  
All the safety and operating instructions should be read before the appliance is operated.
2. **Keep these instructions**  
The safety and operating instructions should be kept for future reference.
3. **Heed all warnings**  
All warnings on the appliance and in the operating instructions should be adhered to.
4. **Follow all instructions**  
All operation and use instructions should be followed.
5. **Do not use this apparatus near water**  
The appliance should not be used near water; for example, near a bath tub, washbowl, kitchen sink, laundry tub, in a wet basement, or near a swimming pool.
6. **Clean only with dry cloth**  
The appliance should be cleaned only as recommended by the manufacturer.
7. **Do not block any ventilation openings. Install in accordance with the manufacturer's instructions.** Slots and openings in the cabinet and in the back or bottom are provided for ventilation, to ensure reliable operation of the product and to protect it from overheating. These openings must not be blocked or covered. The openings should never be blocked by placing the product on a bed, sofa, rug, or similar surface. This product should never be placed near or over a radiator or heat source. This product should not be placed in a built-in installation, such as a bookcase or rack unless proper ventilation is provided or the manufacturer's instructions have been adhered to.
8. **Do not install near any heat sources such as radiators, heat registers, stoves, or other apparatus (including amplifiers) that produce heat.**
9. **Do not defeat the safety purpose of the polarized or grounding-type plug. A polarized plug has two blades with one wider than the other. A grounding type plug has two blades and a third grounding prong. The wide or the third prong is provided for your safety. If the provided plug does not fit into your outlet, consult an electrician for replacement of the obsolete outlet.**
10. **Product the power cord from being walked on or pinched particularly at plugs, convenience receptacles, and the point where they exit from the apparatus.**
11. **Only use attachments / accessories specified by the manufacturer.**
12. **Use only with a cart, stand, tripod, bracket, or table specified by the manufacturer, or sold with the apparatus. When a cart is used, use caution when moving the cart / apparatus combination to avoid injury from tip-over.** An appliance and cart combination should



be moved with care. Quick stop, excessive force and uneven surfaces may cause the appliance and cart combination to overturn.

13. **Unplug this apparatus during lightning storms or when unused for long periods of time.** To protect your product from a lightning storm, or when it is left unattended and unused for long periods of time, unplug it from the wall outlet and disconnect the antenna or cable system. This will prevent damage to the product due to lightning and power-line surges.
14. **Refer all servicing to qualified service personnel. Servicing is required when the apparatus has been damaged in any way, such as power-supply cord or plug is damaged, liquid has been spilled or objects have fallen into the apparatus, the apparatus has been exposed to rain or moisture, does not operate normally, or has been dropped.**
15. **Power source**  
This product should be operated only from the type of power source indicated on the marking label. If you are not sure of the type of power supply to your home, consult your appliance dealer or local power company. For products intended to operate from battery power, or other source, refer to the operation instructions.
16. **Power lines**  
An outside antenna system should not be located in the vicinity of overhead power lines or other electric light or power circuits, or where it can fall into such power lines or circuits. When installing an outside antenna system, extreme care should be taken to keep from touching such power lines or circuits as contact with them might be fatal.
17. **Overloading**  
Do not overload wall outlets and extension cords as this can result in a risk of fire or electric shock.
18. **Object and liquid entry**  
Never push objects of any kind into the product through openings as they may touch dangerous voltage points or short out parts that could result in fire or electric shock. Never spill or spray any type of liquid on the product.
19. **Outdoor antenna grounding**  
If an outside antenna is connected to the product, be sure the antenna system is grounded so as to provide some protection against voltage surges and built up static charges. Section 810 of the National Electric Code ANSI/NFPA 70 provides information with respect to proper grounding of the mast and supporting structure, grounding of the lead-in wire to an antenna discharge product, size of grounding conductors, location of antenna-discharge product, connection to grounding electrodes and requirements for the grounding electrodes.

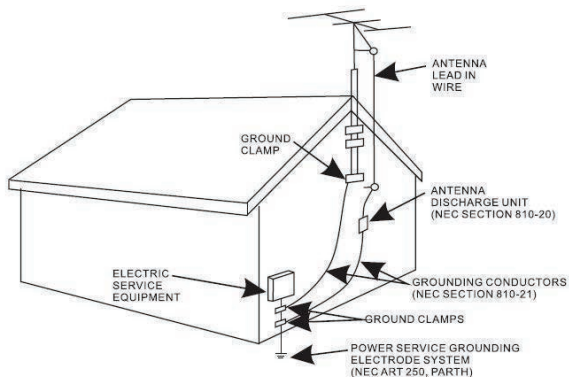

20. **Replacement parts**

When replacement parts are required, be sure the service technician uses replacement parts specified by the manufacturer or those that have the same characteristics as the original parts. Unauthorized substitutions may result in fire or electric shock or other hazards.

21. **Safety check**

Upon completion of any service or repairs to this product, ask the service technician to perform safety checks to determine that the product is in proper operating condition.

22. **Wall or ceiling mounting**

The product should be mounted to a wall or ceiling only as recommended by the manufacturer.

23. **Damage requiring service**

Unplug this product from the wall outlet and refer service to qualified service personnel under the following conditions.

- a) When the power- supply cord or plug is damaged.
- b) If liquid has been spilled or objects have fallen into the product.
- c) If the product has been exposed to rain or water.
- d) If the product does not operate normally by following the operating instructions. Adjust only those controls that are covered by the operating instructions, as an adjustment of other controls may result in damage and will require extensive work by a qualified technician to restore the product to its normal operation.
- e) If the product has been dropped or the cabinet has been damaged.
- f) When the product exhibits a distinct change in performance- this indicates a need for service.

24. **Note to CATV system installer**

This reminder is provided to call the CATV system installer's attention to Article 820-40 of the NEC that provides guidelines for proper grounding and, in particular, specifies that the cable ground shall be connected to the grounding system of the building, as close to the point of cable entry as practical.



**NOTE: Refer all servicing to qualified service personnel. Servicing is required when the unit has been damaged in any way such as the following: the power-supply cord or plug has been damaged, liquid has been spilled into unit, the unit has been exposed to rain or moisture, the unit has been dropped or the unit does not operate normally.**

## CALIFORNIA PROP 65 WARNING



**WARNING:** This product can expose you to chemicals including lead, which is known to the State of California to cause cancer and birth defects or other reproductive harm. For more information go to [www.P65Warnings.ca.gov](http://www.P65Warnings.ca.gov).

## SPECIFICATIONS

|                         |  |
|-------------------------|--|
| AC POWER SOURCE .....   | AC 100-240V~60/50Hz  |
| DC POWER SOURCE .....   | DC 9V  1.5A   |
| POWER CONSUMPTION ..... | 10W  |
| BLUETOOTH RANGE .....   | Up to 10 meters (33 ft)  |
| ACCESSORIES.....        | AC Adaptor<br>Instruction Manual<br>Aux-in Cord<br>(2) Screws, (2) Washers<br>Baseplate  |

Please note: As a result of continual improvements, the design and specifications of this product are subject to change without notice.

Bluetooth is a registered trademark of Bluetooth SIG, Inc.  
Other trademarks and trade names are those of their respective owners.

Made in China.

## ASSEMBLY

**CAUTION:** To ensure that the unit is stable, the unit must never be used without the baseplate attached.

1. Lay a soft protective cloth on a large table or work-surface.
2. Lay the unit on the cloth, on its right side, with the base of the unit accessible at the end of the table.
3. Fit a washer to each of the screws.
4. Bring the base plate up to the base of the unit, lining up the holes in the base plate with the base.
5. Screw in the two screws to secure the base.
6. Fold down the finger grips on the screw heads.
7. Tighten the screws with a screwdriver.
8. The baseplate is now assembled to the unit. Carefully lift the unit off the table and stand it on its base.

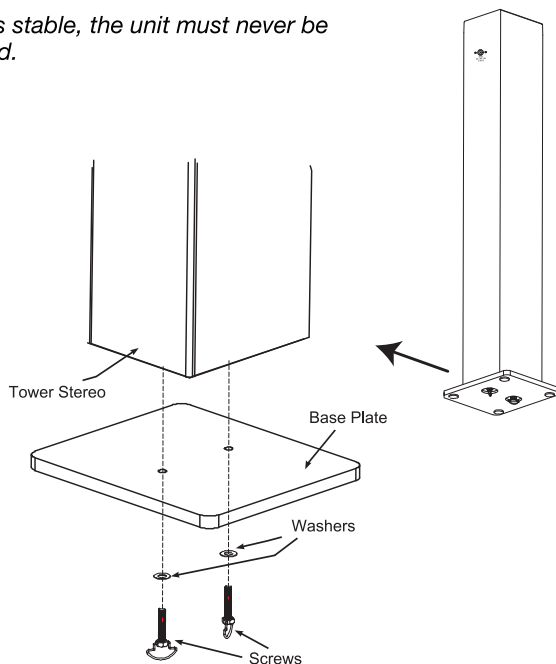

# FUNCTIONS AND CONTROLS

## TOP OF UNIT

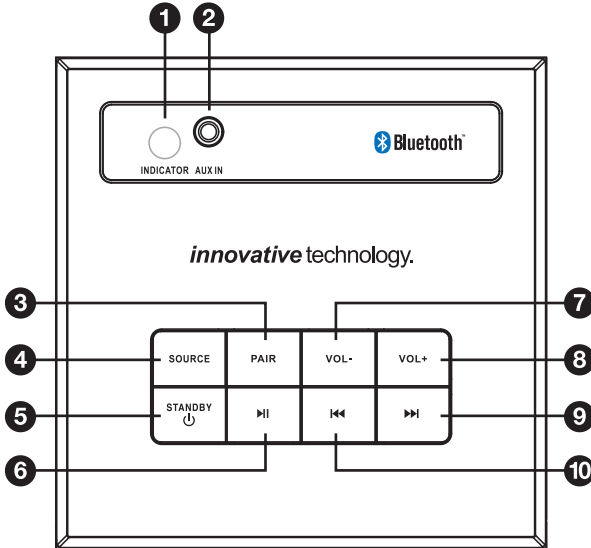

## BACK OF UNIT

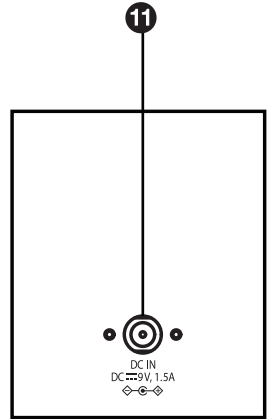

- 1 SOURCE INDICATOR
- 2 AUX-IN JACK
- 3 PAIR BUTTON
- 4 SOURCE BUTTON
- 5 STANDBY BUTTON
- 6 PLAY / PAUSE

- 7 VOLUME DOWN
- 8 VOLUME UP
- 9 ►►
- 10 ◀◀
- 11 POWER ADAPTOR INPUT

# OPERATIONS

## POWER SOURCE:

Insert the adapter plug into a conveniently located AC outlet with 100-240V~60/50Hz.

*WARNING: This unit has a long cord that can easily be tripped on or pulled on, causing injury. Please make sure it is arranged so it will not drape over a tabletop, etc. where it can be pulled on by children or tripped over accidentally.*

### **BLUETOOTH MODE:**

1. Power on the unit (press and hold the STANDBY button) and press the SOURCE button until the SOURCE INDICATOR blinks blue, indicating it is in pairing mode.
2. Activate Bluetooth function on your external Bluetooth device and select “**ITSB-105**” from your device’s Bluetooth settings menu.
3. Once paired, the unit will sound and audible tone, and the indicator will stop blinking.
4. If you want to connect a different Bluetooth device, press and hold the PAIR button to disconnect the currently paired device. Follow the steps above to pair a different device.

*NOTE: The unit will automatically be connected with the last paired and connected device once both of them are in Bluetooth mode and in Bluetooth range.*

### **Control Music**

Press the PLAY / PAUSE to play and/or pause your music.

Press the ◀◀ or ▶▶ button to skip to previous or next track.

### **AUX-IN MODE:**

1. Power on the unit (press and hold the STANDBY button) and press the SOURCE button until the SOURCE INDICATOR’s light turns purple, indicating the unit is now in AUX-IN mode.
2. Securely connect one end of the Aux-In Cable into the AUX-IN JACK, and the other end into your external device’s headphone jack. To start playback, play music through your external device.

*NOTE: You can control your music from your external device ONLY and not through the unit’s control panel when using AUX-IN Mode.*



## TROUBLESHOOTING GUIDE

If you are having problems with your unit, please review the guide below.

| <b>PROBLEM</b>        | <b>POSSIBLE CAUSE</b>                                 | <b>POSSIBLE SOLUTION</b>                                     |
|-----------------------|---|--|
| No power              | Power plug is not plugged into a wall outlet.         | Plug into the wall outlet properly.                          |
|                       | The unit is in standby mode.                          | Press and hold the Standby Button to turn on the unit.       |
| No sound              | Volume is set to minimum.                             | Increase volume level by pressing the VOL + button.          |
|                       | The connected device is not in playing mode.          | Play the music from the connected device.                    |
|                       | Sound output of the connected device is set too low.  | Increase the volume level of the connected device.           |
|                       | Input source is incorrect.                            | Press the SOURCE button until unit is in the correct mode.   |
| Sound distortion      | Volume level is too high.                             | Reduce the volume level by pressing the VOL - button.        |
|                       | Volume level of the connected device is set too high. | Reduce the volume level of the connected device.             |
| Bluetooth not pairing | The external device is too far from the unit.         | Bring the external Bluetooth device closer to the unit.      |
|                       | Failed pairing and connection.                        | Turn unit off and on again. Then try to re-pair your device. |

# WARRANTY

## **Innovative Technology Electronics LLC. Limited Warranty: 90 Days Labor, One Year Parts**

Innovative Technology Electronics LLC. (IT) warrants the product to be free from "Defects" in materials under normal use for a period of "One Year" from the date of the original purchase. The Warranty is "Not" transferable. IT agrees, within the initial "90 Day" period, to repair or replace the product if it is determined to be defective at "No Charge". It is further agreed that IT will cover the cost to repair or replace damaged "Parts" only for a total period of "One Year" from the date of the original purchase. The warranty does not cover cosmetic damage, antennas, AC cords, cabinets, headbands, ear-pads, or damage due to line power surges, connection to improper voltage supply or settings, misusing, mishandling, accident, acts of God or attempted repair by an unauthorized service agent.

**To obtain service, the purchaser MUST present an original sales receipt / proof of purchase. Please contact us at [www.victrola.com](http://www.victrola.com) to request an RMA (Return Material Authorization) number to return products for service or replacement.**

Returns without an RMA number on the package will be refused and returned to sender. Upon receipt of the returning item and our full inspection (IT) may issue a replacement to customer for the same item or of one that has equivalent value and features. To return an item, supply full name, return address, phone number, item purchased, receipt of purchase and reason for return to obtain RMA number.

All returns must be in the original packaging or reasonable substitute to prevent damage. Customer "Must" include full name, shipping address and telephone number inside of package. No return will be shipped back to a PO Box or APO address.

Please include your check or money order in the amount of:

- **USD \$5.00 for items \$10.00 to \$39.99. (Price Paid Per Unit)**
- **USD \$10.00 for items \$40.00 to \$99.99. (Price Paid Per Unit)**
- **USD \$16.00 for items \$100.00 and up. (Price Paid Per Unit)**
- **Shipping fees are non-refundable**

to be payable to Innovative Technology Electronics LLC. (for handling and return shipping charges) (IT) will not be responsible for delays or unprocessed claims resulting from a purchaser's failure to provide any / all of the necessary information. Send all inquiries or RMA request via our website

**[www.victrola.com/pages/technical-support](http://www.victrola.com/pages/technical-support).**

Innovative Technology Electronics LLC.

1 Channel Drive

Port Washington, NY 11050

Toll free: 1-877-483-2497

**Website for support: [www.victrola.com/pages/technical-support](http://www.victrola.com/pages/technical-support)**

There are no express warranties except as listed above.

REPAIR OR REPLACEMENT AS PROVIDED UNDER THIS WARRANTY IS THE EXCLUSIVE REMEDY OF THE CUSTOMER, (IT) SHALL NOT BE LIABLE FOR ANY INCIDENTAL OR CONSEQUENTIAL DAMAGES FOR BREACH OF ANY EXPRESS OR IMPLIED WARRANTY ON THIS PRODUCT EXCEPT TO THE EXTENT PROHIBITED BY APPLICABLE LAW. ANY IMPLIED WARRANTY OF MERCHANTABILITY OR FITNESS FOR A PARTICULAR PURPOSE ON THIS PRODUCT IS LIMITED IN DURATION TO THE DURATION OF THIS WARRANTY.

Some states do not allow the exclusion or limitation of incidental or consequential damages, or limitations on how long an implied warranty lasts, so the above exclusions or limitations may not apply to you. This warranty gives you specific legal rights and you may also have other rights, which vary from state to state.