

# VICTROLA™

by *innovative* technology.



## BLUETOOTH STEREO TURNTABLE WITH CD PLAYER

MODEL: V50-200

### INSTRUCTION MANUAL

Please read instruction manual carefully and keep it for future reference.

<b>Important Safety Instructions</b> .....	3
<b>Product Overview</b> .....	5
<b>Setup/Basic Operation</b> .....	7
<b>Listening to a Vinyl Record</b> .....	8
<b>Listening to a CD</b> .....	9
<b>Listening to the Radio</b> .....	11
<b>Listening to an External Audio Device (Bluetooth Mode)</b> .....	12
<b>Listening to an External Audio Device (AUX Mode)</b> .....	12
<b>Maintenance / Proper Handling</b> .....	13
<b>USB to PC Recording</b> .....	14
<b>Specifications</b> .....	54
<b>Troubleshooting Guide</b> .....	55
<b>FCC Statement</b> .....	58
<b>Industry Canada</b> .....	58
<b>CALIFORNIA PROP 65 WARNING</b> .....	58



- This lightning flash with arrowhead symbol within an equilateral triangle is intended to alert the user to the presence of non-insulated "dangerous voltage" within the product's enclosure that may be of sufficient magnitude to constitute a risk of electric shock.

- **Warning:** To reduce the risk of electric shock, do not remove cover (or back) as there are no user-serviceable parts inside. Refer servicing to qualified personnel.

- The exclamation point within an equilateral triangle is intended to alert the user to the presence of important operating and maintenance instructions in the literature accompanying the appliance.

**CAUTION:** To reduce the risk of fire or electric shock, do not expose this appliance to rain or moisture.

**WARNING:** To prevent electric shock, do not use this (polarized) plug with an extension cord, receptacle or other outlet unless the blades can be fully inserted to prevent blade exposure.



**WARNING:** Invisible laser radiation when open and interlock failed or defeated. Avoid direct exposure to laser beam.

PRODUCT COMPLIES WITH DHHS RULE 21 CFR SUBCHAPTER J IN EFFECT AT DATE OF MANUFACTURE



This equipment is a Class II or double insulated electrical appliance. It has been designed in such a way that it does not require a safety connection to electrical earth.

## Important Safety Instructions

1. Read these instructions – All the safety and operating instructions should be read before this product is operated.
2. Keep these instructions – The safety and operating instructions should be retained for future reference.
3. Heed all warnings – All warnings on the appliance and in the operating instructions should be adhered to.
4. Follow all instructions – All operating and use instructions should be followed.
5. Do not use this apparatus near water – The appliance should not be used near water or moisture – for example, in a wet basement or near a swimming pool, and the like.
6. Clean only with dry cloth.
7. Do not block any ventilation openings. Install in accordance with the manufacturer's instructions.
8. Do not install near any heat sources such as radiations, heat registers, stoves, or other apparatus (including amplifiers) that produce heat.
9. Do not defeat the safety purpose of the polarized or grounding plug. A polarized plug has two blades with one wider than the other. A grounding plug has two blades and a third grounding prong. The wide blade or the third prong is provided for your safety. If the provided plug does not fit into your outlet, consult an electrician for replacement of the obsolete outlet.
10. Protect the power cord from being walked on or pinched particularly at the plugs, convenience receptacles, and at the point where they exit from the apparatus.
11. Only use attachments/accessories specified by the manufacturer.
12. Use only with the cart, stand, tripod, bracket, or table specified by the manufacturer, or sold with the apparatus. When a cart or rack is used, use caution when moving the cart/apparatus combination to avoid injury from tip-over.
13. Unplug the apparatus during lightning storms or when unused for long periods of time.
14. Refer all servicing to qualified personnel. Servicing is required when the apparatus has been damaged in any way, such as power supply cord or plug is damaged, liquid has been spilled or objects have fallen into the apparatus has been exposed to rain or moisture, does not operate normally, or has been dropped.



15. The mains plug is used as disconnect device, the disconnect device shall remain readily operable.
16. **WARNING**  
The apparatus shall not be exposed to dripping or splashing and that no objects filled with liquids, such as vases, shall not be placed on apparatus.
17. The use of the equipment in moderate climate.
18. The ventilation should not be impeded by covering the ventilation openings with items, such as newspapers, table-cloths, curtains, etc.
19. No naked flame sources, such as lighted candles, should be placed on the apparatus.
20. The symbol with  Indication AC voltage.

**ACCESSORIES INCLUDED:**

- INSTRUCTION MANUAL
- WARRANTY (BACK OF MANUAL)
- 45 RPM ADAPTER
- USB CABLE
- SOFTWARE CD

## Product Overview

### Front View

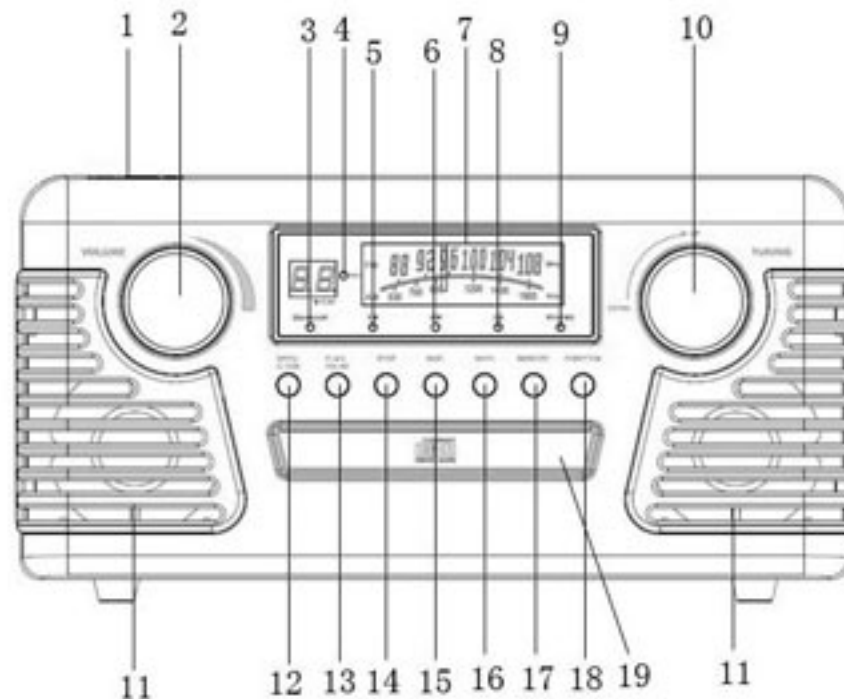

1. **3.5mm HEADPHONE JACK** - Accepts headphones.
2. **VOLUME KNOB** - Turn to adjust volume.
3. **BLUETOOTH INDICATOR** - Blue light will flash when the unit is waiting to be paired.  
The Blue light will stay lit when an external device is successfully paired to the unit.
4. **PROG INDICATOR** - Illuminates to indicate the program playback is set.
5. **FM INDICATOR** - Blue light illuminates to indicate FM mode is set.
6. **AM INDICATOR** - Blue light illuminates to indicate AM mode is set.
7. **DIAL LENS**
8. **CD INDICATOR** - Blue light illuminates to indicate the CD mode is set.
9. **PHONO INDICATOR** - Blue light illuminates to indicate PHONO mode is set.
10. **RADIO TUNER KNOB** - In AM/FM mode, turn knob to tune in a station.
11. **STEREO SPEAKERS**
12. **EJECT** (▲) - In CD mode, press to open and close the disc tray.
13. **PLAY/PAUSE** - Press to start playback, press again to pause.  
(*Note: This button only works in CD, Bluetooth mode.*)
14. **STOP** - Press to stop playback or cancel the program setting.
- 15&16. **PREVIOUS / NEXT TRACK & REWIND / FF** ((I◀◀ or ▶▶I)).
17. **MEMORY** - Press to set the program playback. (*Note: This indicator only works in CD mode.*)
18. **FUNCTION** - Select BLUETOOTH/FM/AM/CD/PHONO mode
19. **DISC TRAY**

**Rear View**

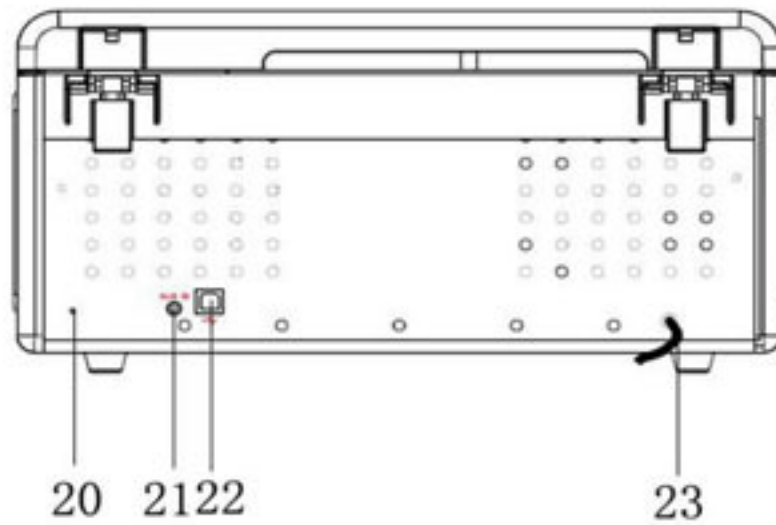

- 20. **FM WIRE ANTENNA** - While tuned to a station in FM mode, extend the wire and reposition to adjust for best reception.
- 21. **AUX-IN SOCKET**
- 22. **USB SOCKET**
- 23. **AC POWER CORD** - Connect the AC plug into a wall outlet.  
It's strongly recommended that this product should be operated only from the type of power source indicated on the marking label.

**Parts of the Turntable**

- A. **Turntable**
- B. **Spindle**
- C. **Adapter for 45 RPM Records**
- D. **Cue-lever**
- E. **Auto Turn / Auto Stop Switch**
- F. **Speed Control Switch**
- G. **Tone Arm**
- H. **Arm Rest**
- I. **Stylus**

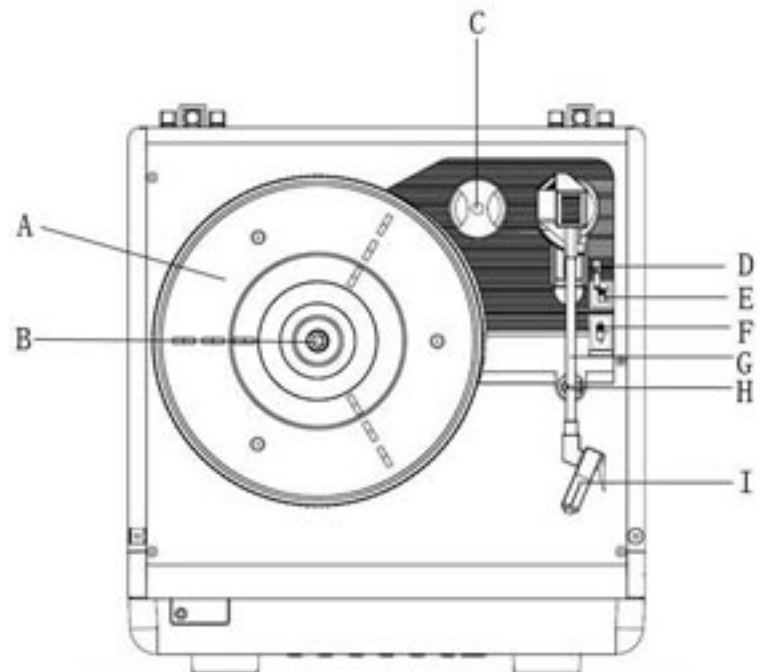

## Setup / Basic Operation

### Setup

1. Remove white protective needle cover by gently pulling towards front of unit.
2. Remove any packaging materials from the unit.
3. Connect the AC power cord to a wall outlet.

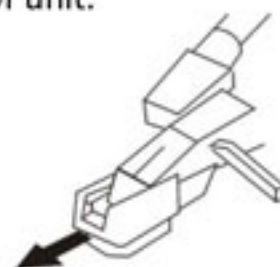

### Note:

- You're strongly recommended that this product should be operated only from the type of power source indicated on the marking label.
- To prevent interference, avoid bundling audio signal cables together with the AC power cord.

## Basic Operation

1. Connect the power plug into the wall outlet.
2. Turn Volume Knob clockwise to turn the unit ON and adjust volume to desired level.
3. Press Function button to select Radio (FM or AM), CD, Phono or Bluetooth.
4. Listening through Earphones/Headphones (not included).

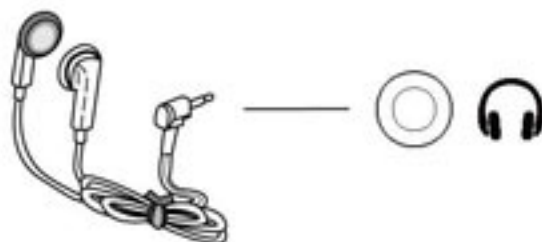

The sound from all speakers is cut off.

## Listening to a Vinyl Record

1. Press the FUNCTION button to select the PHONO function, PHONO indicator will light.

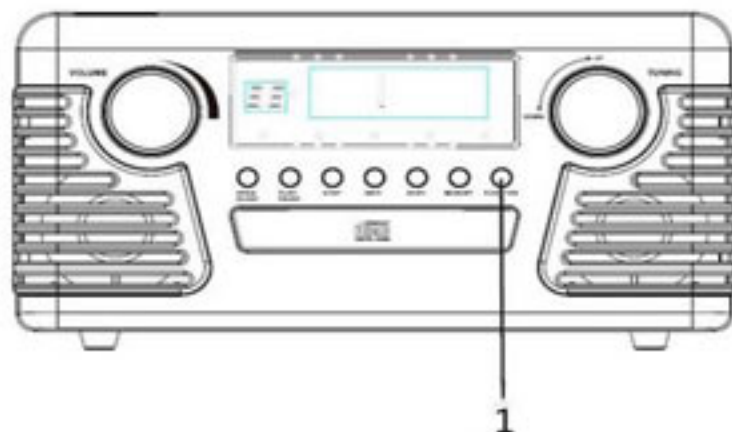

2. Select player speed.

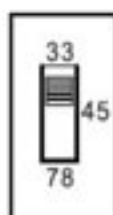



3. Put a record onto the turntable (use the 45 RPM adaptor if needed).

4. Uplift the lift handle.



5. Slide the Auto Turn / Auto Stop Switch to select auto turn or auto stop.

	Auto Turn: Slide the switch on AUTO position, when the record reaches to its end, the turntable will keep turning.
	Auto Stop: Slide the switch to the STOP position, when the record reaches the end, the turntable will stop turning.

6. When the record has finished playing, the TONE ARM will stop at the center of the record and must be returned to the armrest manually.

Note: When playing a 45 or 78 RPM record, we recommend you switch the Auto/Stop switch on AUTO position for greater performance.



## Listening to a CD

1. Press the FUNCTION button to select CD function.



2. Open the tray, and place the CD on the tray.

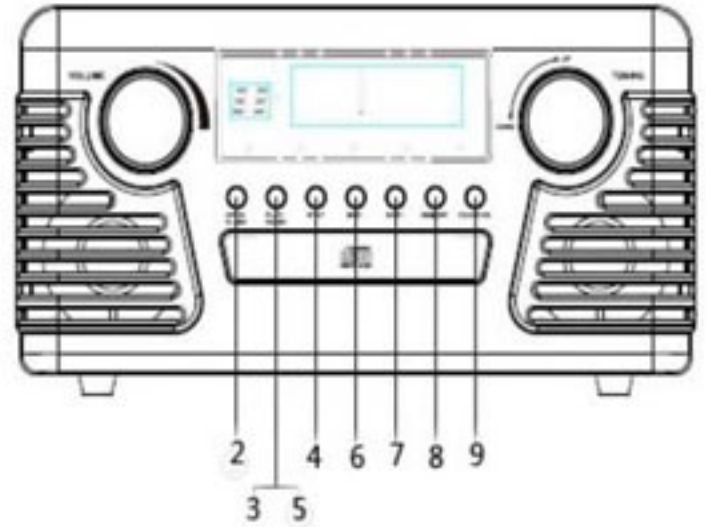

3. Close the tray and start playing the CD.



The CD will start automatically playing from the first track.

4. Stopping the CD player.



5. Pausing the CD player.



Pressing the PLAY/PAUSE button will restart the CD where it was paused.  
Do not switch the unit off while playing a CD, as this will damage the unit.

6. To skip to a different track, press the **I◀◀** or **▶▶I** button until you reach the desired track number. Each press will change the track number by one.

Pressing **▶▶I** button will advance forward from track to track. Press **I◀◀** button once to go back to the start of the current track. Press the **I◀◀** button twice to go back to the start of the previous track.

7. To fast forward during playback, press and hold the **▶▶I** button. Fast forwarding stops when the button is released. To rewind (reverse) playback, press and hold the **I◀◀** button.

8. Press the MEMORY button, the unit will begin the programming function. Program LED will illuminate next to LCD display. In stopped state, press the MEMORY button, the LCD display will flash 01, then press the **I◀◀** or **▶▶I** button to select the tracks, press the MEMORY button to repeat this step to program, and it can program up to 20 tracks. When STOP button is pressed, you can delete this function.

(Note: When all 20 programmed tracks are set, press MEMORY button and "FI" will appear on the display)



## Listening to the Radio

Press the FUNCTION button to select the AM/FM tuning function.

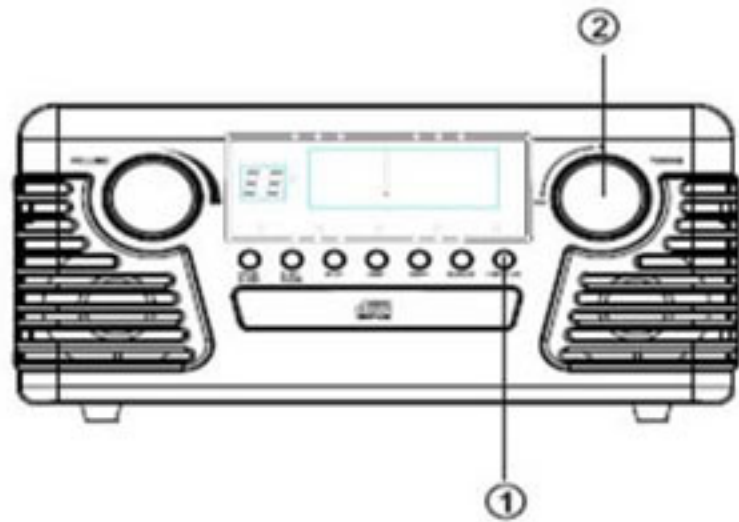

2. Tune to the desired frequency.



3. Antenna

For optimal FM reception, be sure to stretch the built-in FM antenna wire located at the lower back of the unit and move it around until the station you have tuned in is received clearly.

## Listening to an External Audio Device (Bluetooth Mode)

External devices, which have a built-in Bluetooth feature, can be connected to this apparatus and play through the speakers.

### GETTING CONNECTED

1. Press the Function button to select Bluetooth mode.
2. Set the Bluetooth function on your external device to ON.
3. Set to search for a Bluetooth device on your external device.

NOTE: The effective distance between your external device and this apparatus is 10 meters (33 ft).

5. Select "V50-200" on your paired devices list on your external device.  
-If asked for a password, type in "0000" or "1234" then press "OK" on your external device.
6. A few seconds later your Bluetooth connection should be achieved.

## Listening to an External Audio Device (AUX Mode)

In AUX (auxiliary) mode, this unit can play audio from an external audio source (iPod, MP3 Player, Portable CD Player, etc.)

There is an AUX-IN jack on the back of the unit. When connecting a device that has a headphone jack, use a cable with 3.5mm plugs on either end with the front AUX-IN jack.

1. Plug one end of the AUX-IN cable (not included) into the AUX-IN jack.
3. Plug the other end of the cable into the headphone jack of the external audio source.

### NOTE:

1. *All operations are only available on your external device.*
2. *When inserting an AUX-IN cable (not included) into the AUX-IN jack, only the VOLUME knob will work.*

## Maintenance / Proper Handling

### Compact Disc Handling

- Always place the disc on the disc tray with the label side facing upward (compact discs can be played/recorded only on one side).
- To remove a disc from its storage case, press down on the center of the case and lift the disc upward, holding it carefully by its edges.
- To clean a disc, wipe the surface from the center hole outward towards the outer edge with a soft, dry cloth.
- Never use such chemicals as record spray, antistatic sprays or fluid, benzine or thinner to clean discs; they will irreparably damage the disc's plastic surface.
- Discs should be returned to their cases after use to protect from dust and scratches.
- Do not expose discs to direct sunlight, high humidity, or high temperature for extended periods of time.
- Printable CD-R and CD-RW discs are not recommended, as the label side may become sticky and damage the unit.
- Use a soft oil-based felt-tipped pen to write information on the label side. Never use a ball-point or hard-tipped pen, as doing so may damage the recorded side.
- Do not use irregularly shaped CDs (octagonal, heart shaped, business card size, etc), as they will damage the unit.
- Read all precautions supplied with any CD-R or CD-RW disc.
- Never handle a disc with dirty fingers.
- Never insert a disc that has a crack on the surface.

### Handling Vinyl Records

- Do not touch the record's grooves. Only handle records by the edges or the label with clean hands. Touching the record surface will cause your record's quality to deteriorate.
- To clean a record, use a soft anti-static cloth to gently wipe the record surface.
- Keep records in their protective sleeves when not in use.
- Always store records upright on their edges.
- Avoid placing records in direct sunlight, close to a heat source (radiators, stoves, etc.), or in a location subject to vibration, excessive dust, heat, cold or moisture.

### General Care

- When removing the power plug from the wall outlet, always pull directly on the plug. Never pull the cord.
- To keep the laser pickup clean, do not touch it, and do not forget to close the disc tray.
- Do not attempt to clean the unit with chemical solvents as this might damage the finish.
- For cleaning, only use a clean, dry cloth.
- In order to shut off the power to this product completely, unplug the power cord from the wall outlet. Be sure to unplug the unit if you do not intend to use it for an extended period of time.

### How to Replace the Turntable Stylus

*The stylus should last about 50 hours under normal use. However, it is recommended that the stylus be replaced as soon as you notice a change in sound quality. Prolonged use of a worn-out stylus may damage the record. The highest speed of 78 RPM records would wear out the stylus more quickly.*

#### **Removing the old stylus:**

1. Set a screwdriver at the tip of the stylus and push downward (A).
2. Remove the stylus by pulling it simultaneously downward and forward.



#### **Installing a new stylus:**

1. Hold the front tip of the stylus and insert its rear edge (B) first.
2. Push the stylus upwards (C) until the tip locks into place.



Guide Pins (inside)

#### **Caution:**

- Do not bend the stylus.
- Do not touch the needle to avoid injury your hand.
- Turn off the unit's power before you replace the stylus.
- Keep out of reach of children.

### Audacity Software – Version 2.1.2

The provided CD contains the following software:

(1) Audacity\_for\_MAC-----For Mac (page 36)

(2) Audacity\_for\_WIN -----For Windows

The software is compatible with Windows XP, VISTA, 7, 8 & 10 (requires appropriate drivers) and Mac.

#### **NOTE:**

- Read about Audacity on Windows 8, 7 and Vista. Windows 2000, NT, and 95 are not supported.
- Windows 10 is supported, but subject to all enabled devices having Windows 10-compatible drivers designed for the device. This should be the case for the built-in sound device of a new computer that came with Windows 10. Please see our Windows 10 page for solutions if you encounter problems. We hope to improve our Windows 10 compatibility with older devices in a future release.
- A CPU that supports SSE2 is required (any CPU made after 2003 should support this). Please use the legacy Audacity 2.0.6 version if your machine lacks SSE2 support.
- Audacity for Mac is a Universal Binary for OS X 10.6 and later. Audacity runs best with at least 1 GB RAM and a 1 GHz processor (2 GB RAM/2 GHz on OS X 10.7 and later).
- For lengthy multi-track projects, we recommend a minimum of 2 GB RAM and 2 GHz processor (4 GB RAM on OS X 10.7 and later).
- The 2.1.1 release was the final release for PPC Macs.

Because of the variation of different operation systems, some of the interface may not be the same as below.

### Audacity Installation and USB Connection

Connect one end of USB cable to the turntable and the other end into your computer. Then connect the AC power cord of the turntable.

### Audacity for Windows

#### Installing the Audacity Software

1. Please insert the Audacity software disk that comes with your unit. Go to My Computer and double click the CD ROM Drive.

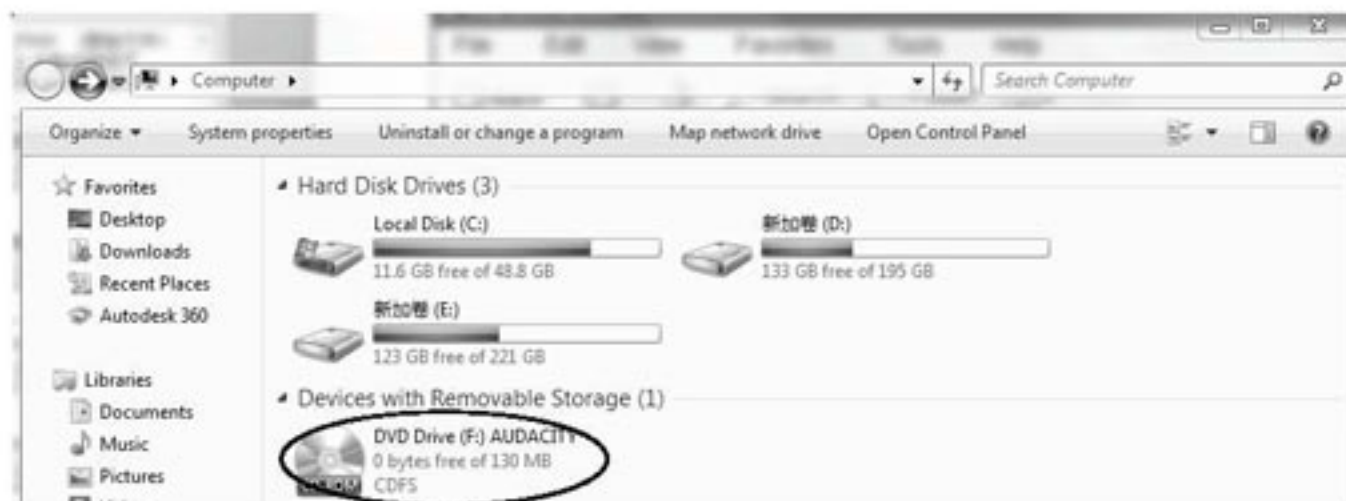

2. Select Audacity-for-win for window system.



3. Double click the audacity-win-2.1.2 to install the audacity software.



4. Select the setup language first and click OK to continue.

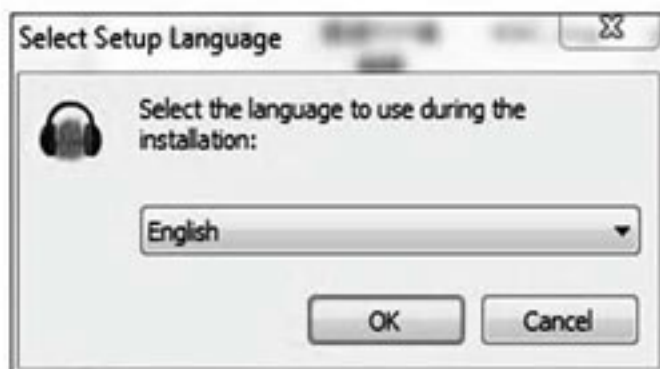

Note: The language choice in the Windows EXE Audacity installer only selects the language for the installer.

5. The Audacity Setup Wizard will appear. Click on Next to install the software.



## 6. Continue to click on the Next buttons.

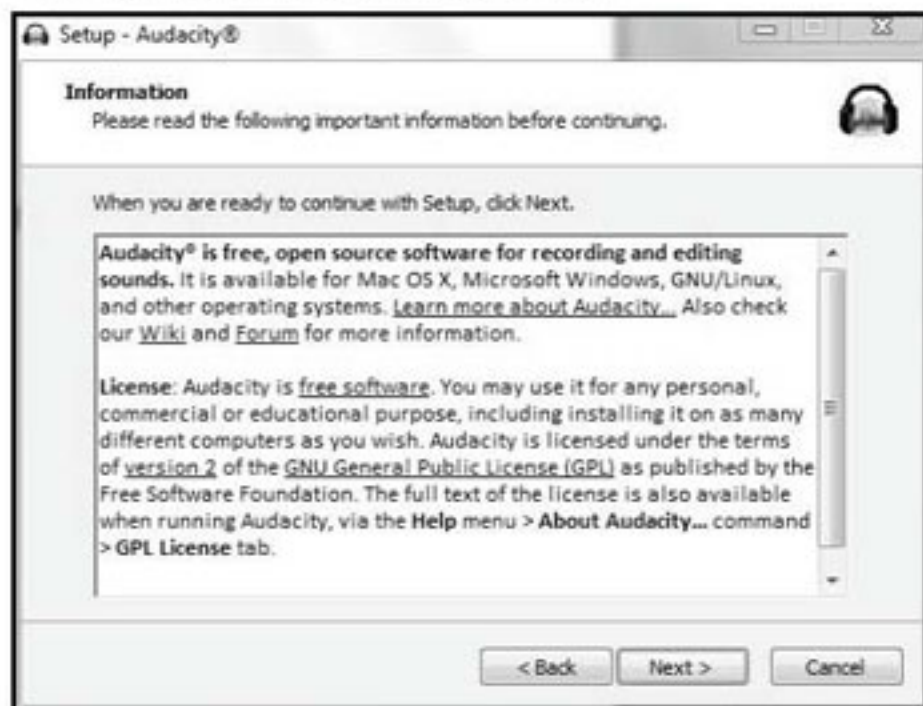



7. Click on the Install button to start installation.

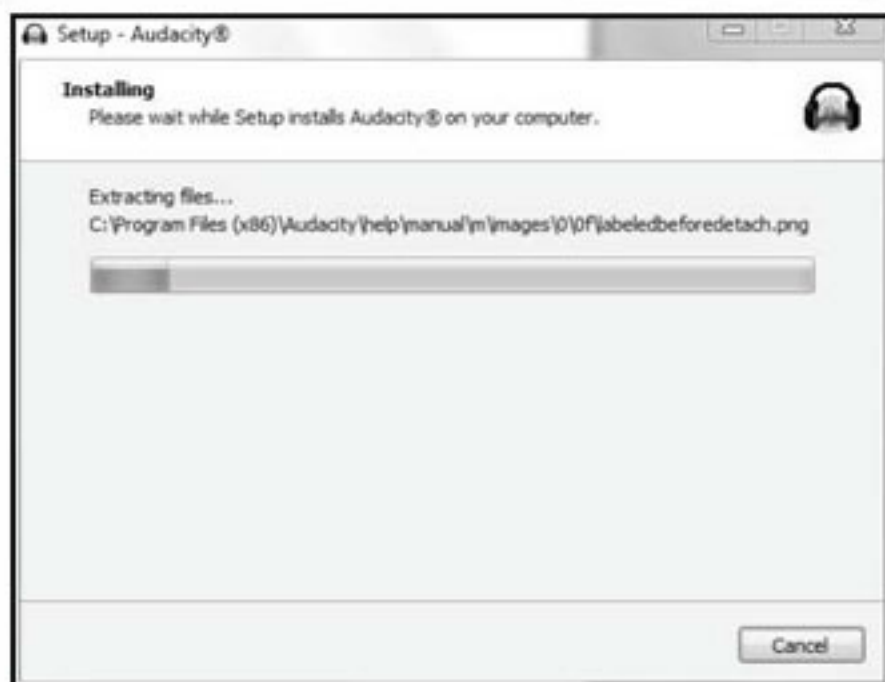

8. Click on Next to continue.



9. Click on Finish to complete installation.



10. You can now open the Audacity software and start recording your files.

**Note:**

1. Once you set up Audacity, you do not need to re-set it with each use.
2. The "Audacity-win-2.1.2.exe" (help file included) is available for Windows 8/ Windows 7/ Windows 10 requires appropriate drivers / Windows Vista/ Windows XP.
3. If you cannot run the exe document, please go to the website below and download the file from it directly.

<http://www.audacityteam.org/download/windows>

4. Users upgrading to this release from Audacity 2.0.5 or earlier who had FFmpeg installed will see a notice that FFmpeg needs to be reconfigured. Please visit [http://manual.audacityteam.org/o/man/faq\\_installation\\_and\\_plug\\_ins.html#ffdown](http://manual.audacityteam.org/o/man/faq_installation_and_plug_ins.html#ffdown) for a link to the recommended 2.2.2 version of FFmpeg for Windows and Mac OS X, and for information for Linux.
5. The Windows installer for 2.0.x versions will replace legacy 1.2.x or any previous 2.0.x installation, but install alongside legacy 1.3.x Beta versions. It is strongly recommended to uninstall previous Beta versions before installing current Audacity.
6. Audacity 2.1.2 requires the CPU to support the SSE2 instruction set, which should be available on any Intel hardware produced after 2001 and any AMD hardware produced after 2003. To check what SSE levels your CPU supports, you can install CPU-Z. If your hardware only supports SSE, you may download Audacity 2.0.6 from <http://www.olfoss.com/Audacity.html>.
7. Users on Windows XP: You may see "Entry Point Not Found" when first launching Audacity after installation. This error occurs if you are running less than the latest "Service Pack" of updates for your Windows XP system. Please see [http://manual.audacityteam.org/o/man/faq\\_installation\\_and\\_plug\\_ins.html#entry\\_point](http://manual.audacityteam.org/o/man/faq_installation_and_plug_ins.html#entry_point) for how to install the latest Service Pack and for advice about the potential security risks of running XP now that Microsoft no longer supports it.
8. On first use of Audacity you need to confirm or cancel the Register Effects dialog for detected effects before you can launch Audacity. (For additional information, please visit the website at [http://manual.audacityteam.org/o/man/effects\\_preferences.html#register](http://manual.audacityteam.org/o/man/effects_preferences.html#register))

## Configuring Audacity for Microsoft Windows

### Audacity Interface



#### Upper Toolbar dock area

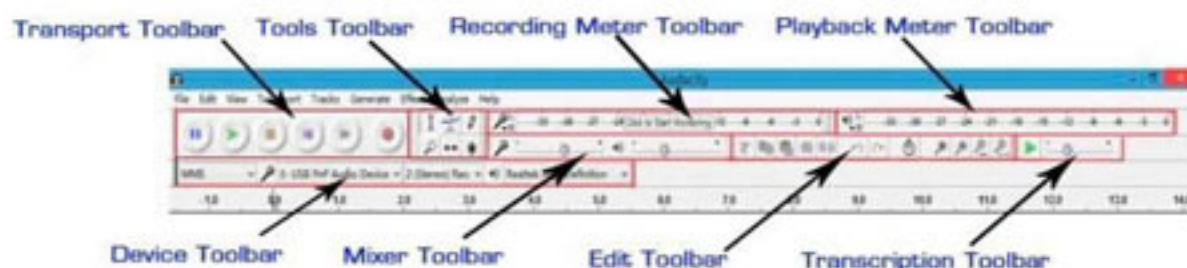

#### Audacity Control Buttons

Use the attribute controls button at the top of the screen to go to Pause, Play, Stop, Beginning, End, Record, etc. Use the File, Edit, View, Transport, Tracks, Generate, Effect and Analyze menus to Save, Export, and Edit the music.

1. Click the (⏸) button to pause the recording;
2. Click the (▶) button to play;
3. Click the (⏹) button to stop the recording;
4. Click the (⏮) button to skip to start;
5. Click the (⏭) button to skip to end;
6. Click the (⏺) button to record;
7. Adjust the input volume;
8. Adjust the output volume;

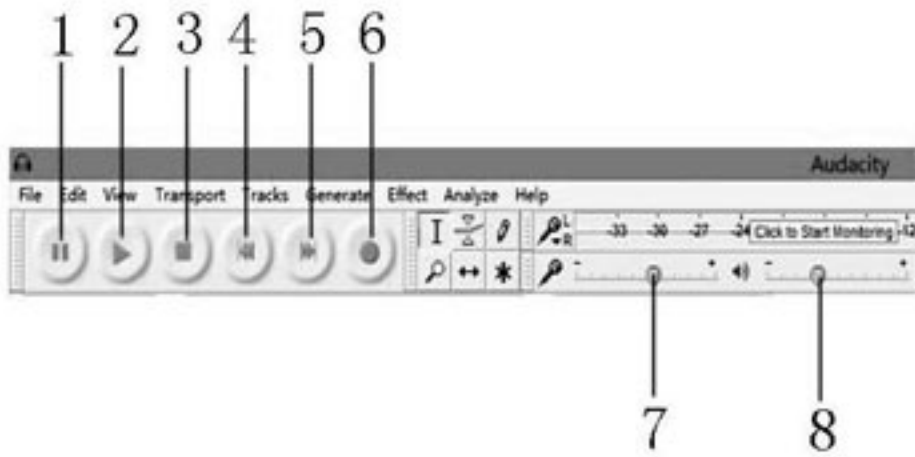

## Audacity Preferences

1. Click the "Edit" on the Audacity interface, select "Preferences".



In the pop-up window of the Audacity Preferences, tabs of Devices, Playback, Recording, Quality, Interface, Tracks, Spectrograms, Import / Export, Extended Import, Projects, Libraries, Directories, Warnings, Effects, Keyboard, Mouse and Modules are listed on the left side of the window as shown in the picture on the following page.

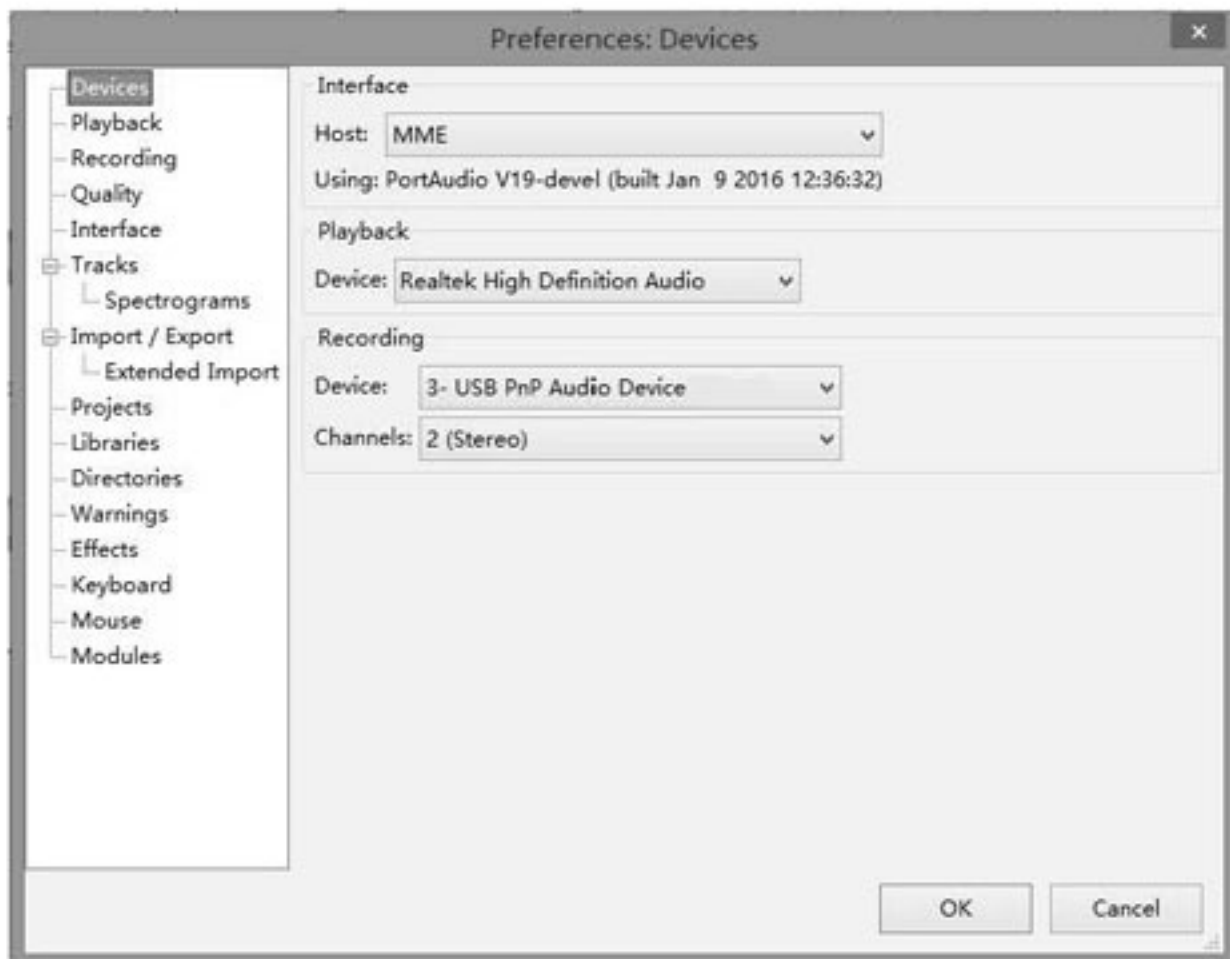

2. Click 'Devices' on the left side and detailed contents of the Devices will appear on the right hand side of the interface.

Click the ▼ arrow on "Device" below Playback and choose "Realtek High Definition Audio" or "Microphone Sound Mapper- Output".

Click the ▼ arrow on 'Device' below 'Recording' and choose "USB PnP Audio Device".

Click the ▼ arrow on 'Channels' to select '2(Stereo)'. Do not click OK until you finish all of the settings.

**Note:** If you cannot find the "USB PnP Audio Device" in the Device list, close the Audacity Software and re-open and try again.

Windows Vista and later call most USB external devices "microphones" but Windows XP and earlier do not. Some higher-end USB recording interfaces may appear as their explicit manufacturer's name.

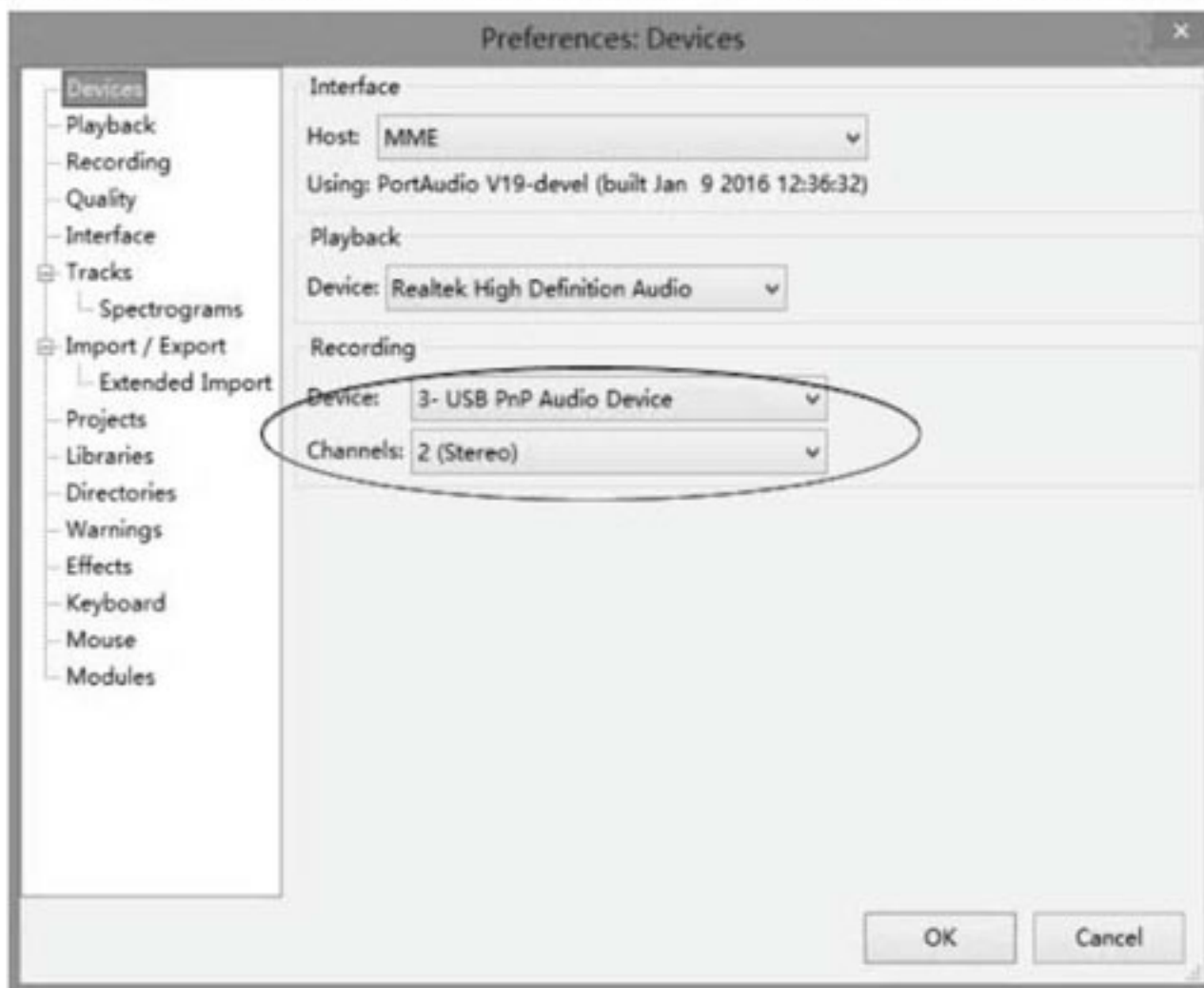

3. Click 'Recording' on the left side and the detailed contents will display on the right side. Click the checkbox beside 'Software Playthrough: Listen while recording or monitoring new track'. Click the checkbox beside 'Sound Activated Recording' and adjust the Sound Activation Level (dB) to -36.

**NOTE:** Once the 'Sound Activated Recording' is selected, the Pause button will not work during recording. You can Click "Interface" on the left side to select Sound Activation Level.

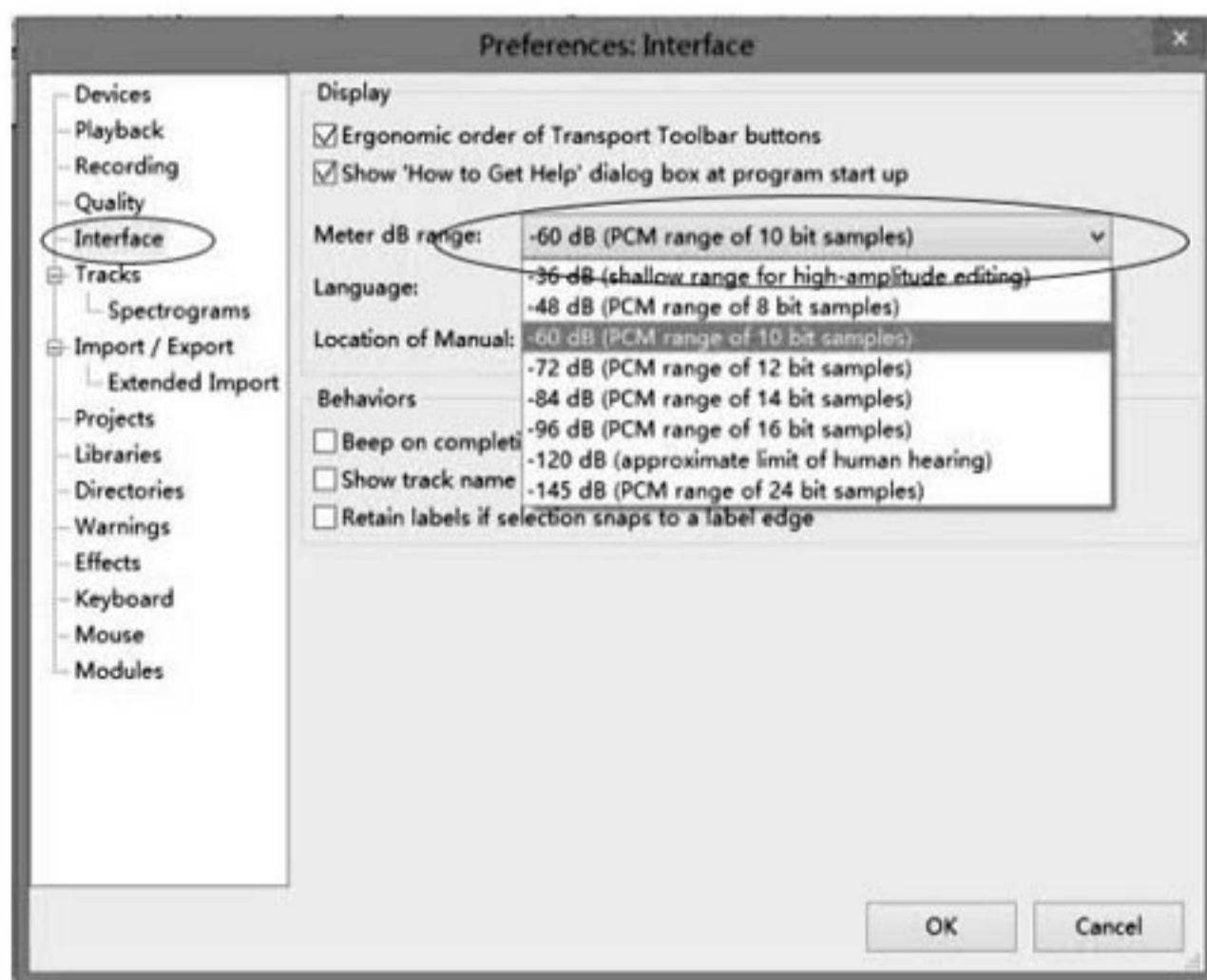
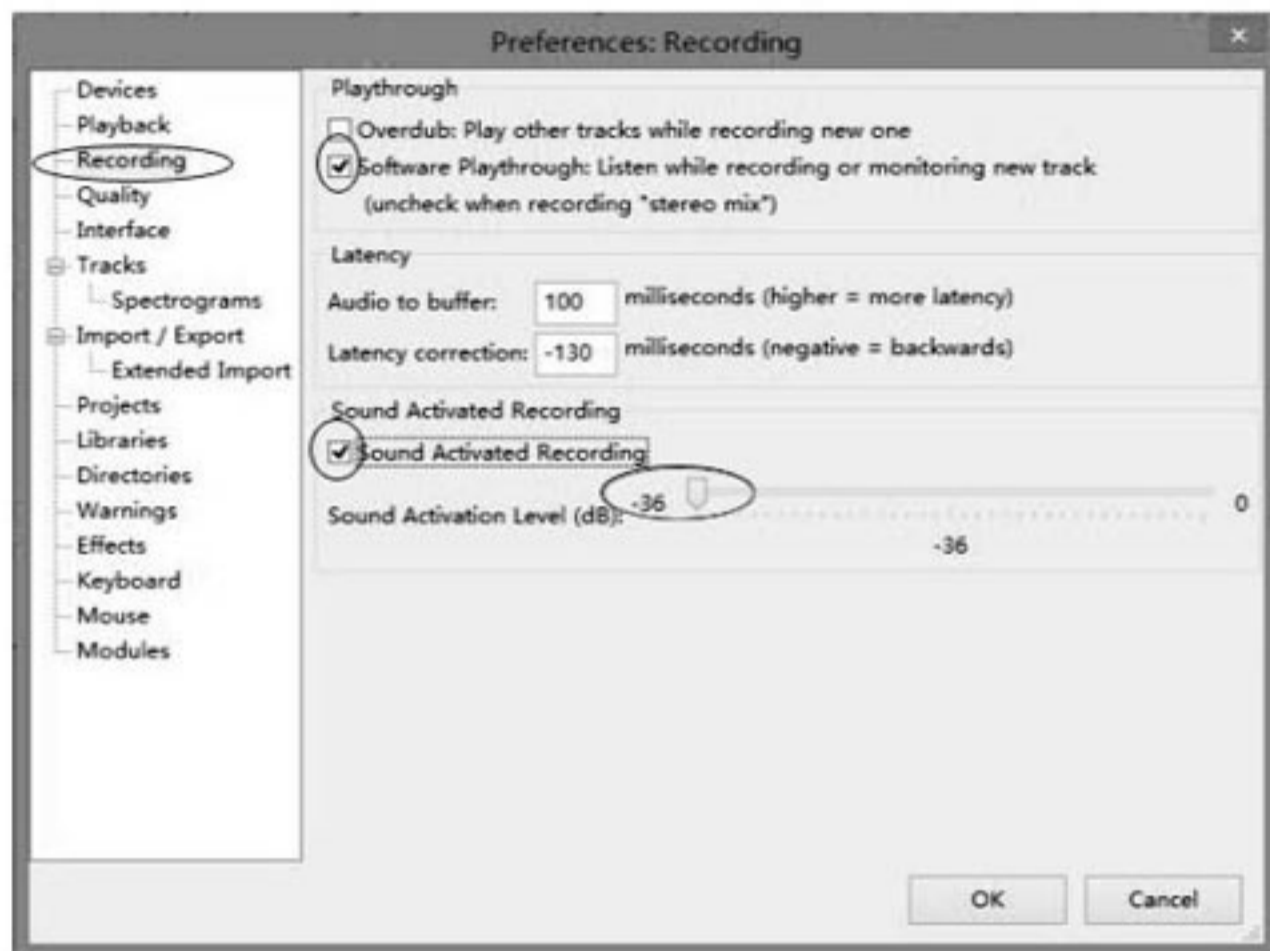

4. Before exporting an MP3 file, you need to find 'lame' first. If the program does not show the MP3 Library, make sure the Audacity driver disc is inside your computer. Click 'Libraries' on the left side, then in 'MP3 Export Library' interface, click 'Locate...' button to find 'lame\_enc.dll'.

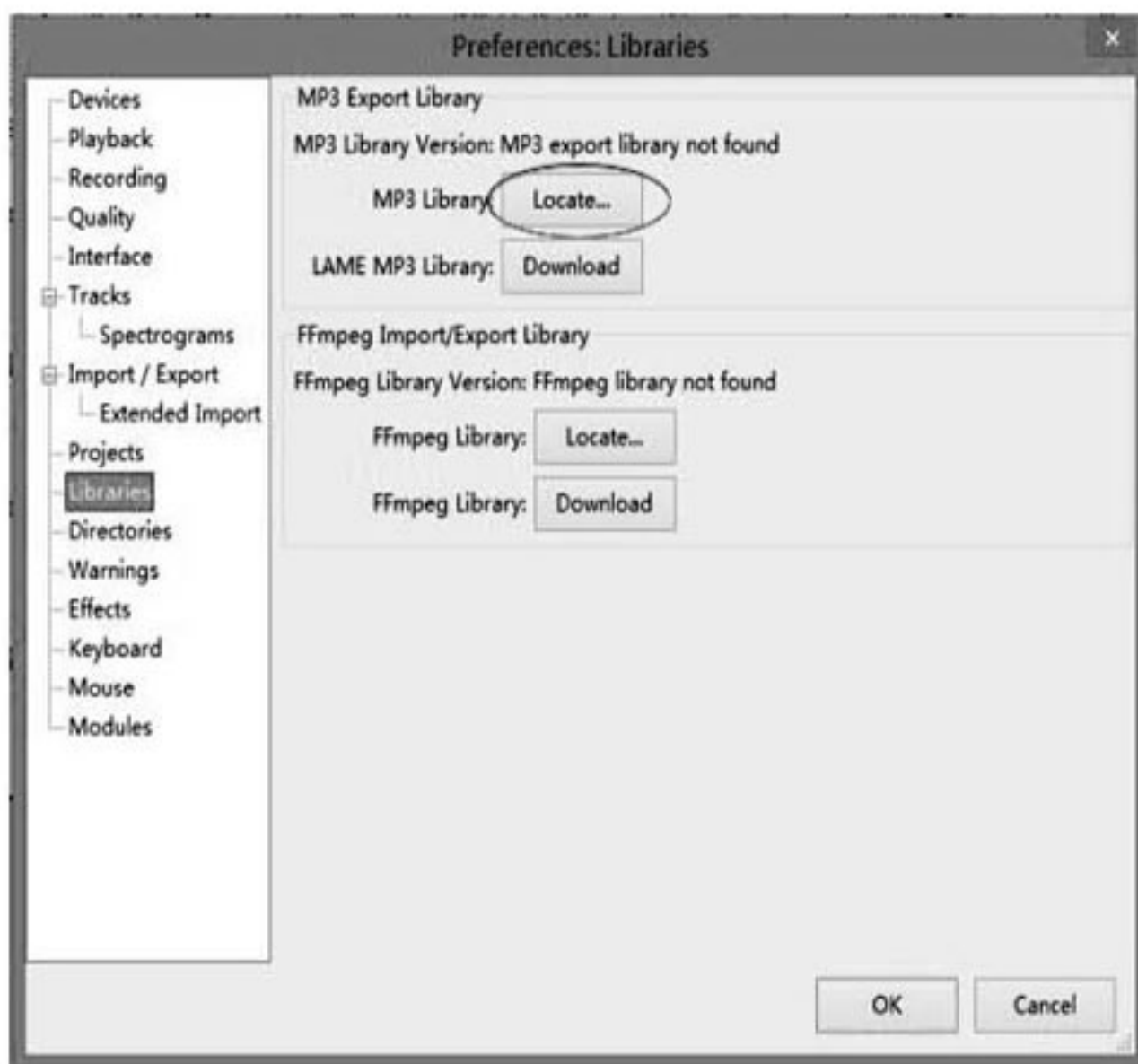

5. You can download the 'lame' software from the website. Click 'Download' and a website will be opened automatically.

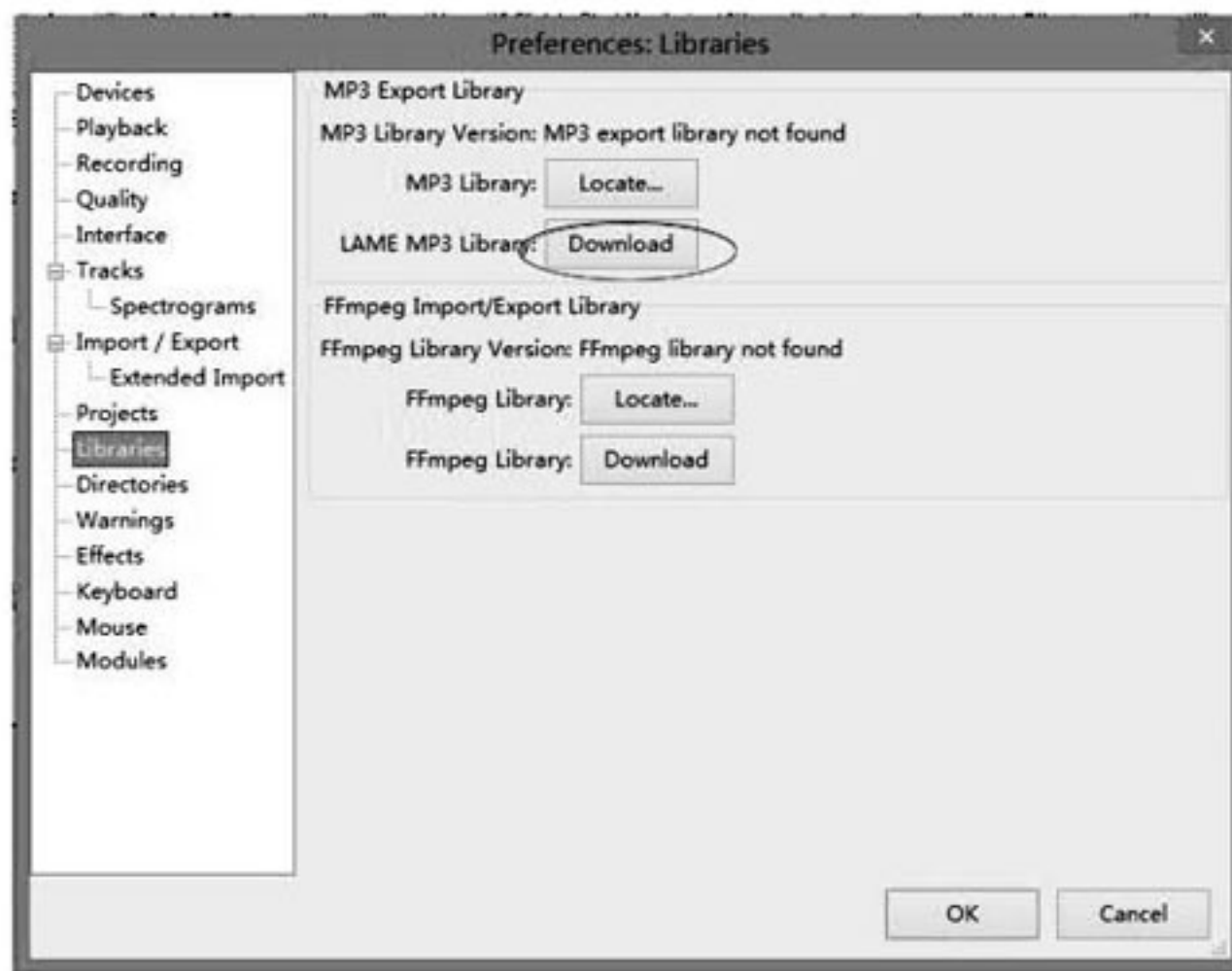

Open the website to download 'lame\_enc.dll': click on LAME download page.

## Windows

1. Go to the external [LAME download page](#)  
Left-click this link, do not right-click.
2. Directly underneath "For FFmpeg/LAME on Windows click below.", left-click the link **Lame v3.99.3 for Windows.exe** and save the file anywhere on your computer.
3. Double-click "Lame v3.99.3 for Windows.exe" to launch it (you can safely ignore any warnings that the "publisher could not be verified").
4. Follow the Setup instructions to install LAME for Audacity, making sure not to change the offered installation location of "C:\Program Files\Lame for Audacity" (or "C:\Program Files (x86)\Lame for Audacity" on a 64-bit version of Windows).

You should now be able to export MP3s without any further configuration, choosing **File > Export Audio...** then selecting "MP3 Files" in the Export Audio Dialog.

## Troubleshooting

Occasionally, there may be a conflict where Audacity still tries to detect the path to an older lame\_enc.dll file. To correct this:

1. Ensure there are no older versions of lame\_enc.dll in any locations where Audacity detects it, namely:
  - C:\Program Files\Lame for Audacity or C:\Program Files (x86)\Lame for Audacity (this is where the installer puts the new .dll)
  - the Audacity installation folder (usually C:\Program Files\Audacity or C:\Program Files (x86)\Audacity), or in the "Plug-Ins" folder inside that.
2. Exit Audacity and navigate to the **audacity.cfg** preferences file at:
  - Windows XP: Documents and Settings\<user name>\Application Data\Audacity\audacity.cfg
  - Windows Vista/Windows 7/Windows 8: Users\<user name>\AppData\Roaming\Audacity\audacity.cfg



In order to see audacity.cfg, you may need to set the operating system to show hidden files and folders. See instructions for [Windows 7](#) and [Windows versions before 7](#).

Jump straight to 'Windows download' in the top line. Left click 'Windows download' and it will jump to the download chapter for Windows.

Click Here, Windows User ----> **Jump straight to Windows downloads** ←

Click Here, MAC OSX User ----> Jump straight to MAC OSX downloads

Audacity LAME is free, so you can click 'libmp3lame-win-3.99.3.zip' under ZIP OPTION to download.

Click Save, select the Folder you want to save it in, then click Save again to save it.

### TO DOWNLOAD Lame and FFmpeg for Windows, click links BELOW:

If Audacity does not detect LAME, download the ZIP option, extract the files inside to a well known folder, then open Audacity, go to Library Preferences and configure it to search on the well known folder you extracted the files to.

**NOTICE: As of 2014-June-27 Clam Antivirus is showing a false positive for Lame\_v3.99.3\_for\_Windows.exe**

[Lame\\_v3.99.3\\_for\\_Windows.exe](#) - (SHA256 SUM [here](#))

### ZIP OPTION:

**libmp3lame-win-3.99.3.zip** (Issues? Some help [HERE](#))

Close the webpage, then click OK to close the Audacity preference. Minimize Audacity interface, then open the Folder where you saved the libmp3lame-win-3.99.3. Double click on it, then double click on it again to open. Now left click on lame\_enc.dll. Hold and drag it to your Desktop.



**NOTES:**

- Once you move it to the Desktop you do not need to do this again.
- After opening lame\_enc.dll the first time it may not be necessary to open lame\_enc.dll the next time you record.

Go back to Audacity and click on Edit, then Preferences. Click on Libraries in MP3 library. Click on Locate, then click on 'Browse'. Click on Desktop, then click on Lame\_enc.dll to highlight it. Then click Open.

Click on OK on locate Lame box. Click OK on Audacity Preferences to close and to complete your settings. Now you can Record, Export and Save your favorite music.

8. For detailed information about how to run this program, please click 'Help' and click 'Manual (in web browser)'.

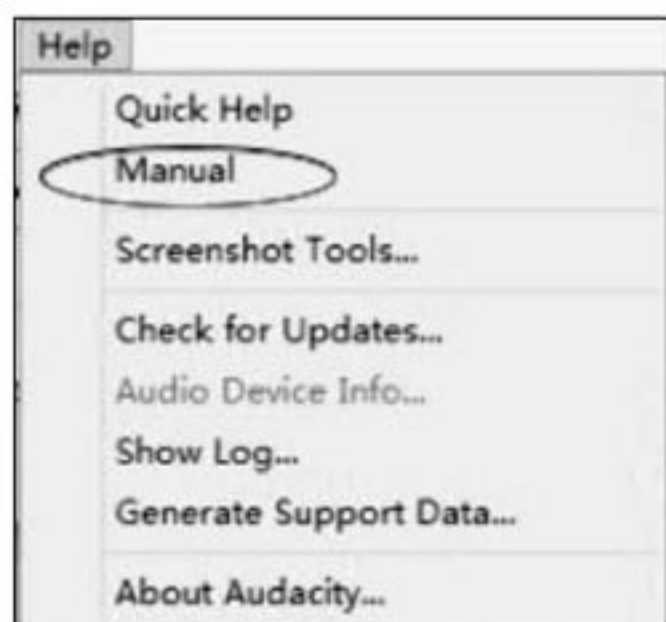

7. Adjust the output and input volume to 20% (or 0.2 level).



**NOTE:** Because of the variation of different operation systems, the input volume control may not work on some individual Windows versions. Windows Vista is recommended to ensure the input volume control works properly.

For any queries in regard to 'Mixer Toolbar' please visit:

[http://wiki.audacityteam.org/index.php?title=Mixer\\_Toolbar\\_Issues](http://wiki.audacityteam.org/index.php?title=Mixer_Toolbar_Issues)

## RECORDING OPERATION

To download music and save into computer:

1. Place the record on the turntable.
2. Move the tone arm over to the record to start playing.
3. Click the Record (  ) button to start recording.

The waves (left and right tracks) will show on the interface.

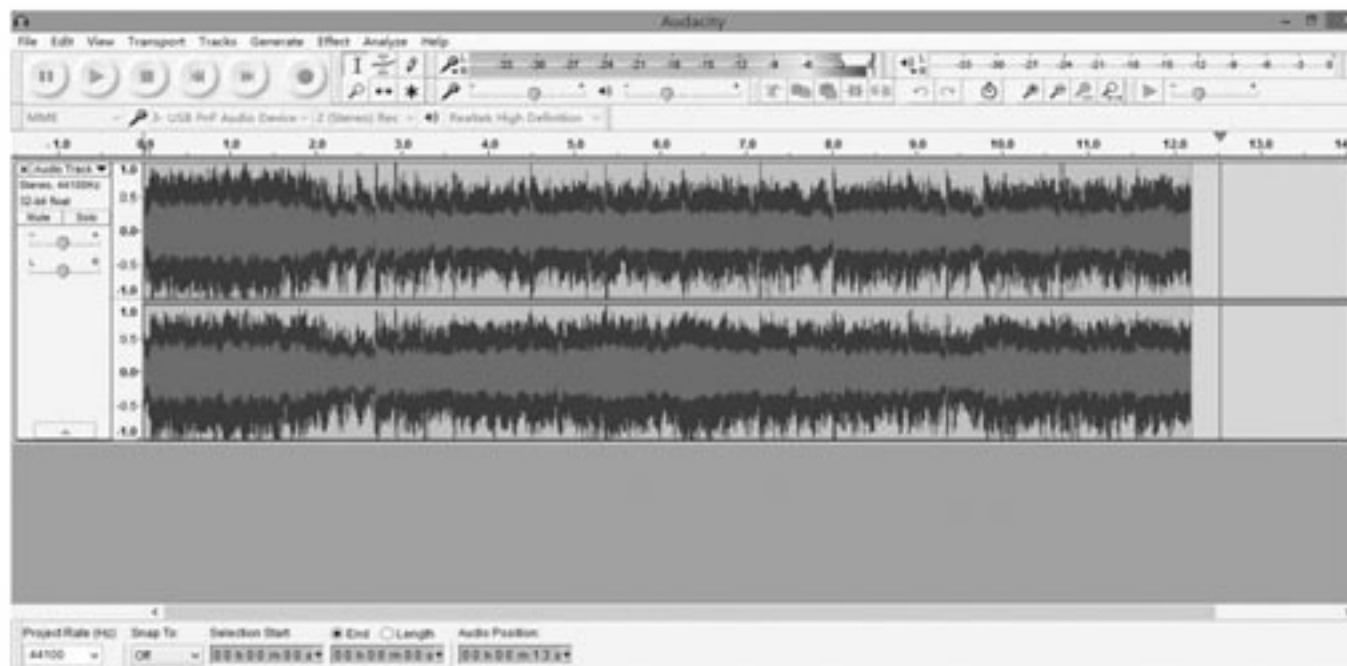



4. At end of a song, click the "pause" (  ) button on the computer and press the Stop button on the turntable, move the cursor to the wave area and left click at the end of the song.

For the next song, replace the album or move tone-arm to another desired song. Press the Play button on the turntable to start playing the next song. Immediately press the "pause" (  ) button on the computer and downloading will continue and another R/L track will appear on the interface.

NOTE: Pause button will not work during the recording process if the 'Sound Activated Recording' in Preferences Recording is selected. Clear the checkbox next to 'Sound Activated Recording' if you want to manually pause recording.

5. Repeat steps 3 and 4 until you have finished downloading.

**NOTE:** Do not click stop button on the computer when continuously downloading songs. Remember to click pause button in between your desired songs. Press stop button on the computer only when all your desired songs have been downloaded.

After your have finished downloading, you may play back the songs through your computer. In stop mode, simply click (  ) SKIP TO START button and then the (  ) PLAY button.

**TIP:** If you press the "stop" button by accident, you can click "Transport" and click "Append Record" and you can continue to record in the same track.



For example, if the “stop” button has been pressed by accident at the end of the first song, do not click anything in Audacity. Prepare another song, click “Transport” tab and select “Append Record”. The second song will continue to record on the same track at the end of the first song.

You now have a music download on your computer but the music needs to be saved and converted to WAV, OGG, or MP3 formats before exporting.

### GENERAL PROBLEMS FOR WINDOWS VERSION

1. If you do not have the fluctuating wave on the interface during recording, or the recording sounds unsatisfactory, adjust the recording volume as follows:

- Click Start in the left corner of the computer, select Settings, Control Panel.



- In Control Panel interface find Sounds and Audio Devices. Double click the icon to enter Sounds and Audio Devices Properties interface.



• In Sounds and Audio Devices Properties interface Volume window will display, select the Audio tab to reveal the settings.

In Sound recording, select USB PnP Audio Device and click the Volume button to set the recording input level. The WAVE IN window will appear.



• In WAVE IN interface Adjust the recording volume to about 50% as per illustrated below.

The fluctuating wave will show on the interface when recording.

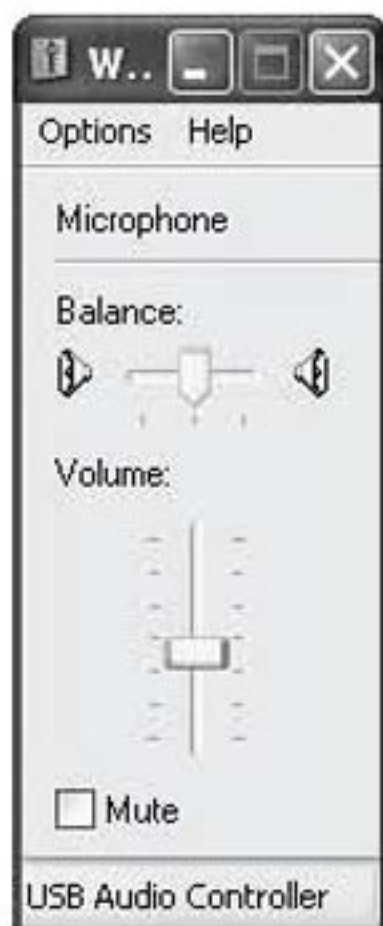

2. If you do not hear any sound when the turntable is connected and you wish to listen to the music and/or video, it is possible that the default playback device has been changed to USB PnP Audio Device when the turntable connects to the PC.

Recommended: Remove the USB cable from the PC.

Alternative: This solution requires you to change the setting manually every time you connect the USB cable to the PC.

Change the setting as follows (see following page):

## • For Vista and Windows 7 users:

Click “Start” and go to the Control Panel. Find and click “Sound” icon. Sound window will be opened and the “Playback” window will be seen. You will see that the Speaker USB PnP Audio Device is set as default. To ensure the sound, click a playback device (e.g., Speaker High Definition Audio), then click “Set Default” and click OK. The sound should now work.



## • For Other Windows versions users (e.g.: Windows XP):

Click “Start” and find “Settings”, “Control Panel”. In the Control Panel window, find and double click into “Sounds and Audio Devices”. In the Sounds and Audio Devices Properties window, Volume window will be seen. Click the “Audio” tab to reveal the settings. In the Sound playback section, you will see that the USB PnP Audio Device is selected.

To enable the sound, click the pull-down arrow and select your inbuilt sound device or sound card by name as the playback device (e.g., Realtek) and click OK and the sound should be enabled.



# DIVIDING TRACKS

After you have finished downloading, you may play back the songs through your computer before exporting. In stop mode, simply click (⏮) SKIP TO START button and click then the (▶) PLAY button.

1. Press (⏮) button to return to the beginning of the first song.
2. Move cursor to the wave graphic area, left click mouse and hold then drag from left to right. Release the mouse when the highlight reaches the end of the first song.

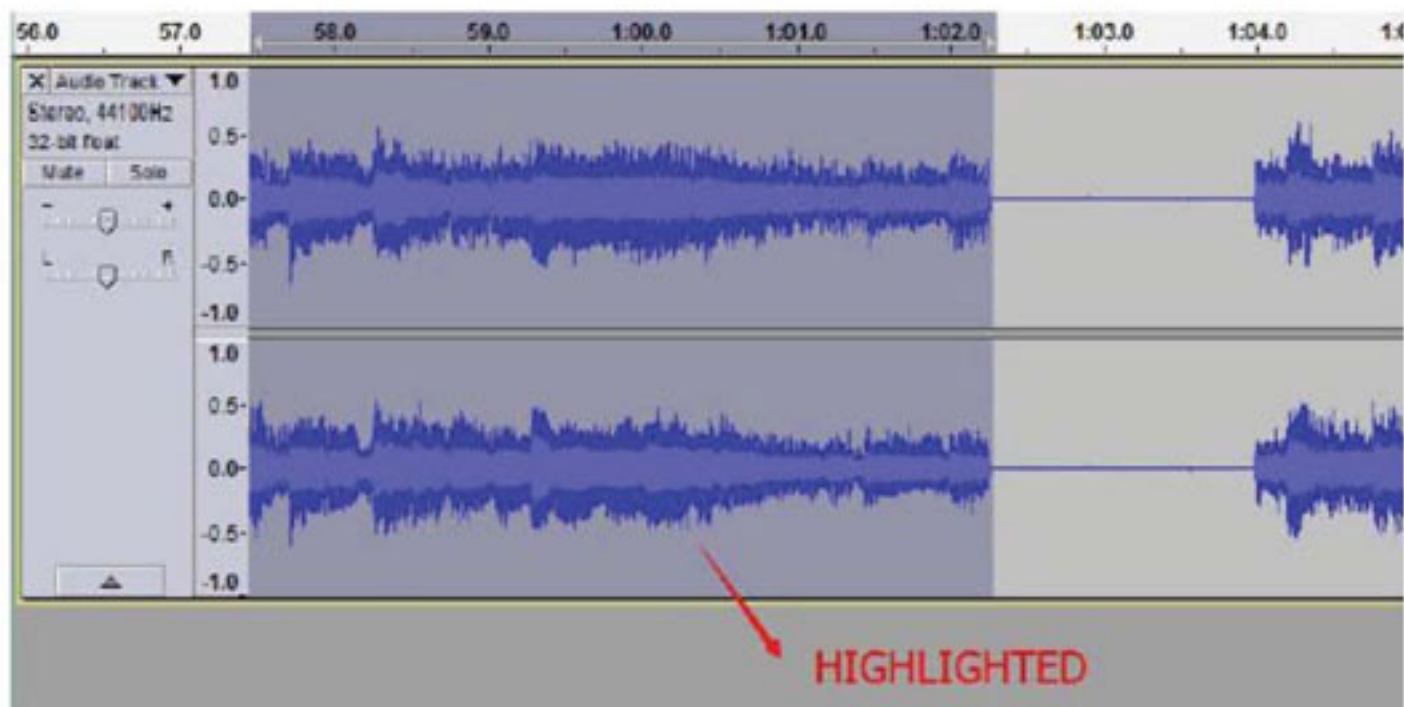

3. Click "File" tab then select "Export Selected Audio...".

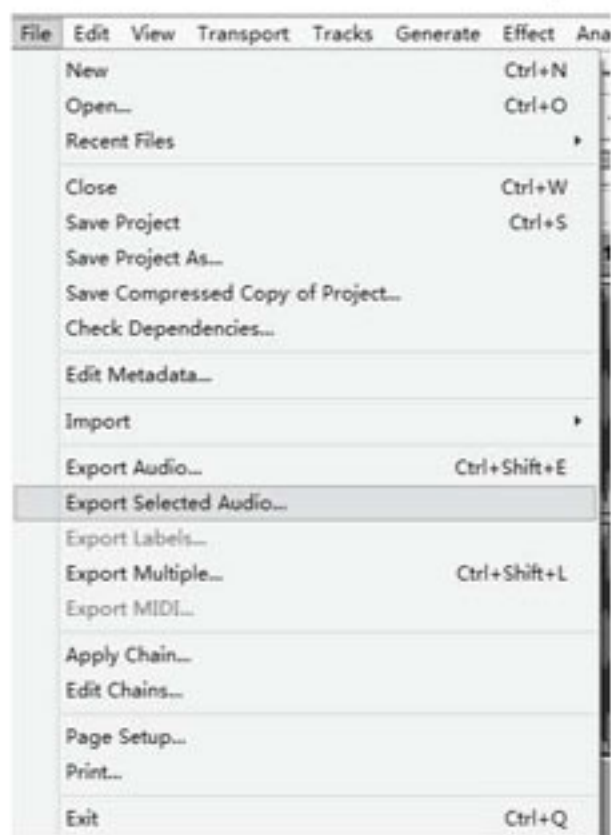

4. In the next window, select a location as well as the format (most people prefer to save audios in MP3 format (MP3 format is most common)) in MyMusic and put the title in the file name. Click "Save".

*NOTE: The most common formats are: MP3, WAV (WAV uses a lot of space), and MYA/AAC (most iPod devices can play audios with this format).*

You can also choose alternative formats such as AIFF, OGG or FLAC if these formats are supported on both your computer and the exported devices. Note that according to your selection, the Edit Metadata window may not appear.



5. In the next window, fill in the information in the window entitled "Edit Metadata". Then click "OK".

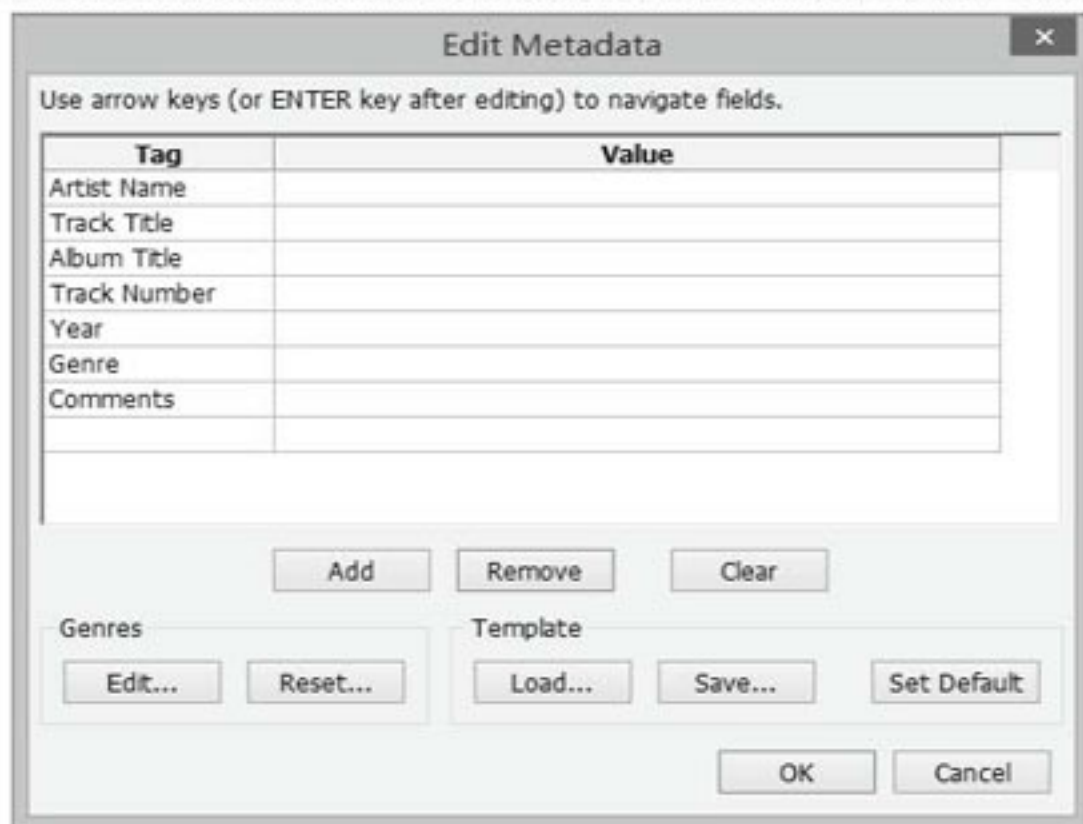

Wait a few seconds before exporting the selected audio.



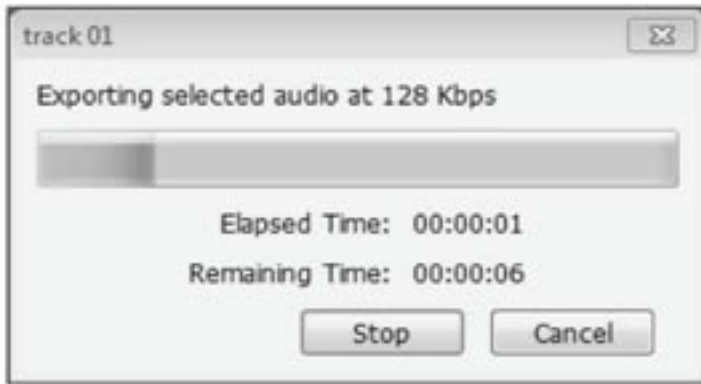

### Second song to be divided and saved:

1. Move cursor to the wave graphic at the beginning of the second song. Left click mouse and hold then drag from left to right until you reach and highlight the end of the second song.
2. Click "file" tab then select "Export Selected Audio...".
3. Follow above steps to divide songs, export and save, one-by-one.

## MP3, WAV AND OGG FORMAT

THESE ARE DIGITAL FILE FORMATS FOR AUDIO (MUSIC) AND MOST CURRENT COMPUTERS ARE COMPATIBLE. HOWEVER, IF YOU COPY THE FILE ONTO A CD DISC (CD-R OR CD-RW) AND PLAY WITH ANOTHER CD PLAYER, YOU HAVE TO MAKE SURE THE CD PLAYER SUPPORTS THOSE FORMATS; OTHERWISE, THE COPIED CD DISC WILL NOT PLAY. THE SAME THING IS TRUE WITH A COPIED FILE TO BE PLAYED ON ANOTHER MP3 PLAYER.

## EXPORT AND SAVE FOR WAV AND OGG FORMATS

(AFTER RECORDING IS COMPLETE)

When the song is finished, click (⏏) on the screen to stop playing.  
You can export and save tracks individually, or export and save into one file.

### To export and save individually:

1. Highlight the song that you want to save then click the file tab on the audacity interface.

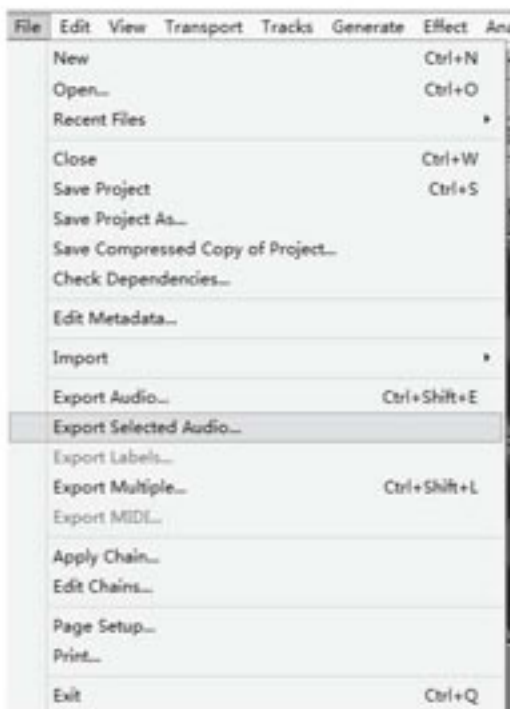

2. Select "Export Selected Audio...", a window will appear as below:



Select the folder, put title in the file name and click the pull-down arrow to select a save type, such as WAV or OGG format.

3. Choose the file format of the recording that should be exported and put in the title in the file name and the folder of the location where it will be saved, i.e. desktop. Then click "Save".

4. Edit Metadata window may appear, complete the information then press the OK button.

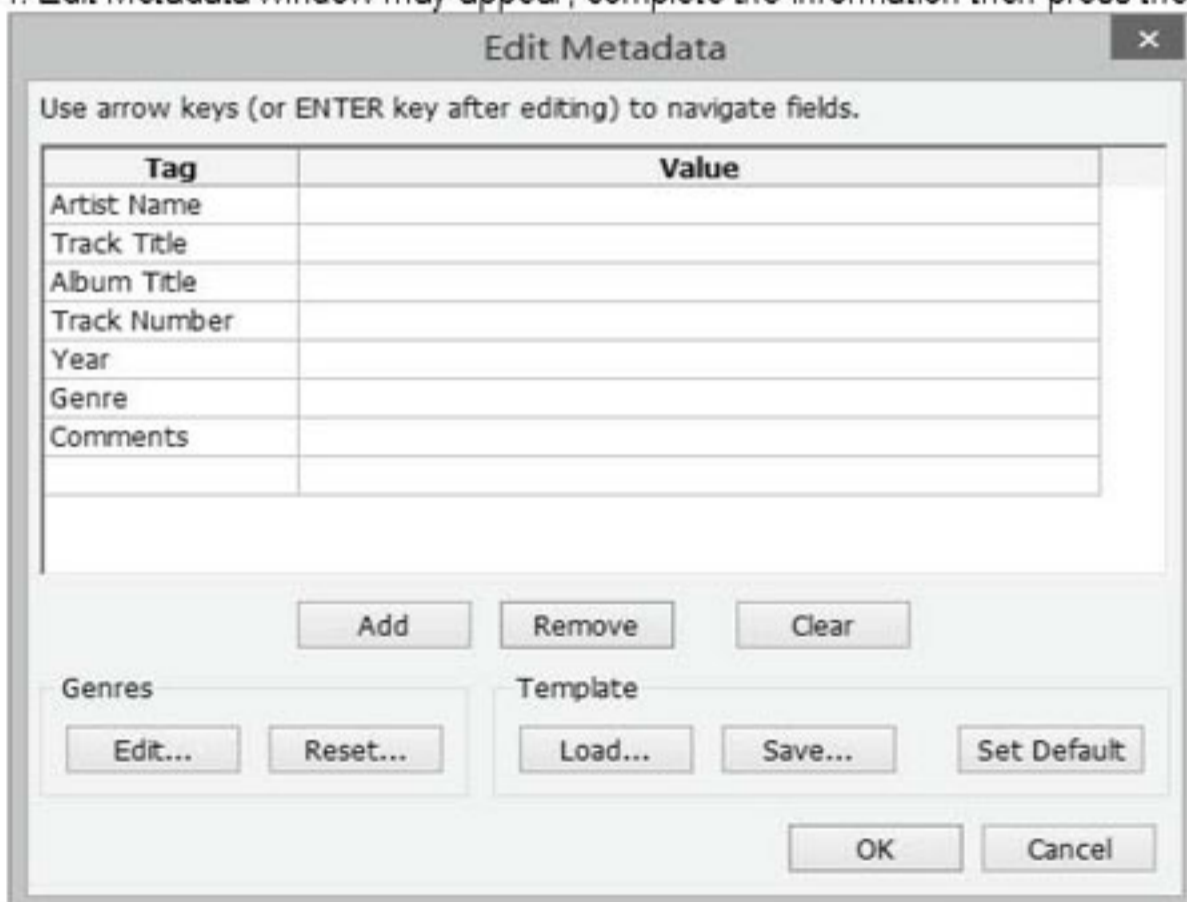

5. Wait for a few seconds until the export & saving is completed.

# SETTING THE LANGUAGE

1. Click Edit and select Preferences.

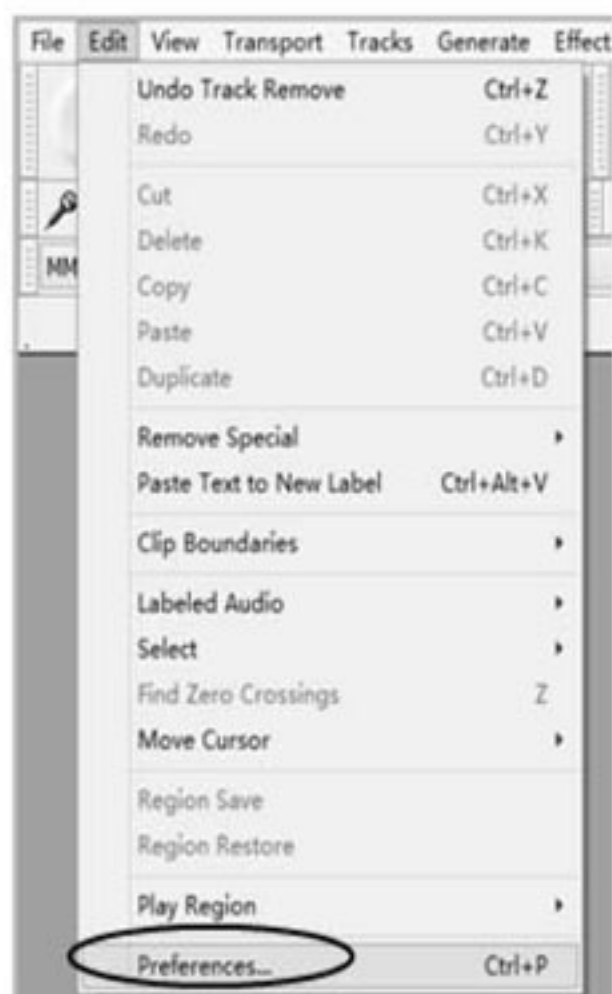

2. Another window titled with Audacity Preferences will appear. Click the Interface tab and click the pull down arrow to select the language you wanted.

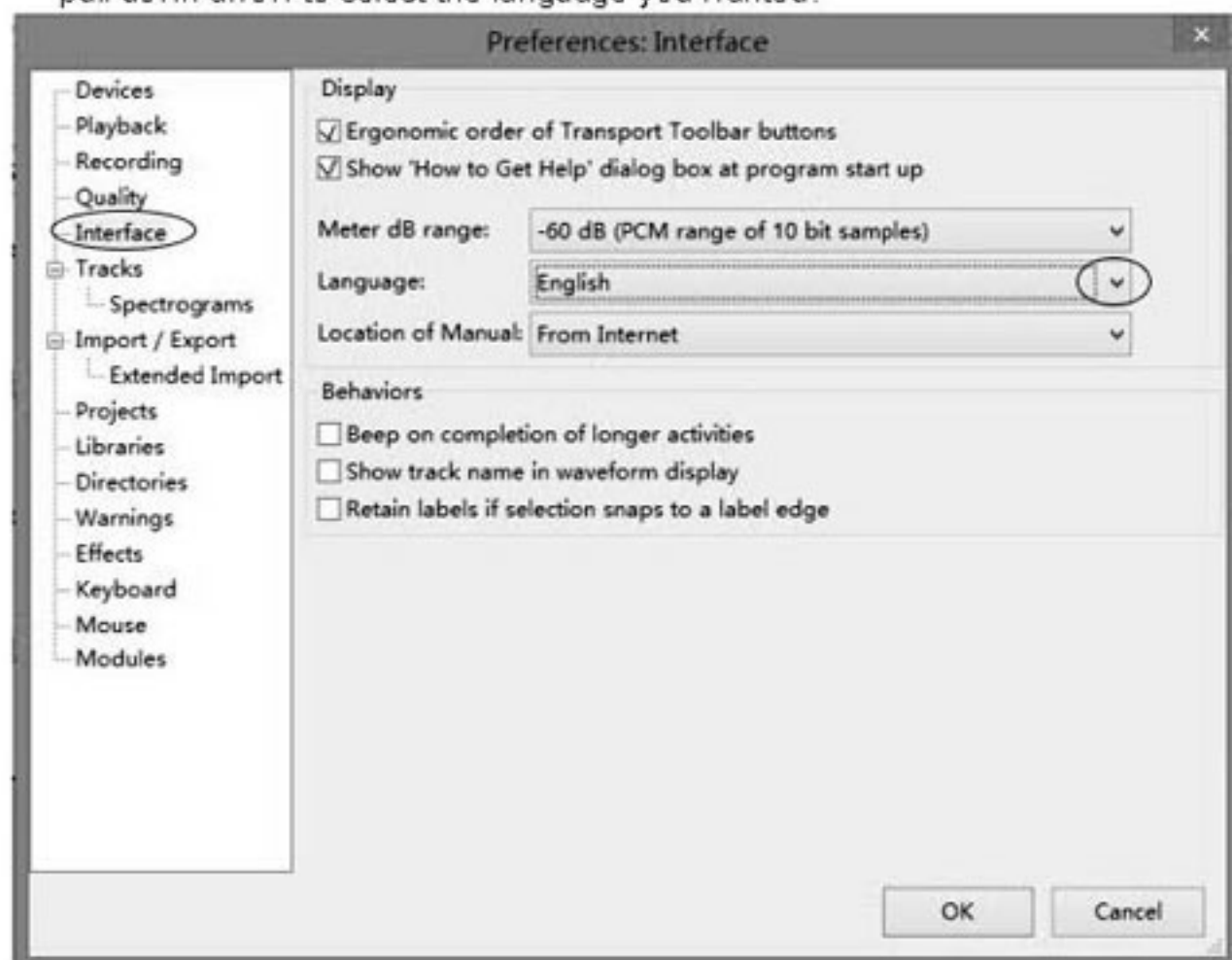

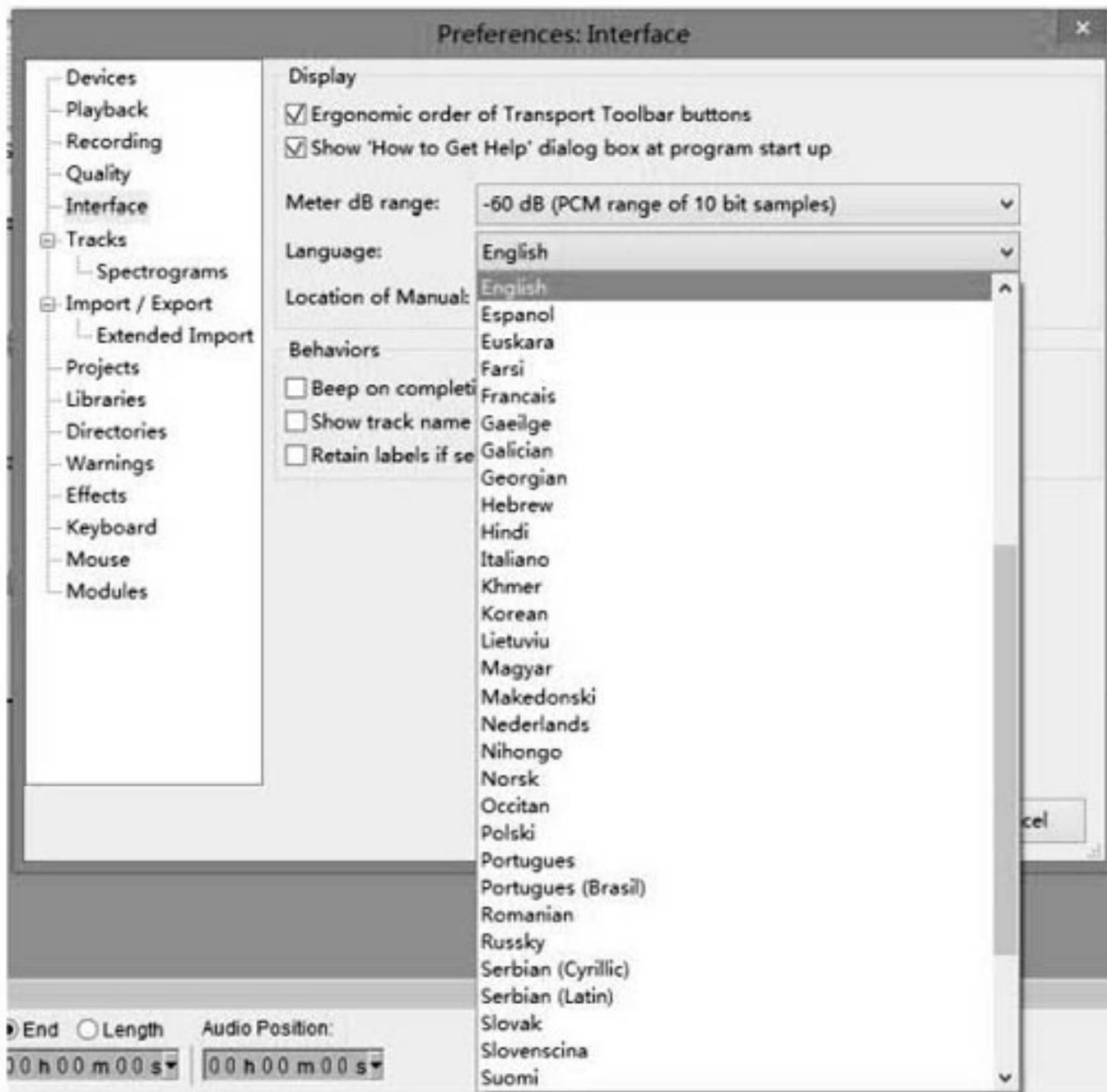

3. Then click OK to close the window. The new setting will only be active in the next start - that means you need to close the Audacity and re-open the software again.

## Audacity for Mac Users

### System Requirements

Audacity for Mac is a Universal Binary for OS X 10.6 and later. Audacity runs best with at least 1 GB RAM and a 1 GHz processor (2 GB RAM/2 GHz on OS X 10.7 and later).

For lengthy multi-track projects, we recommend a minimum of 2 GB RAM and 2 GHz processor (4 GB RAM on OS X 10.7 and later).

1. Please insert the Audacity software disk that comes with your unit. Click the Audacity disk on the desktop.

2. Select Audacity\_for\_mac for Macintosh system.



TIPS: To check your computer OS version, you can click the Apple icon then select "About This Mac".



The next window will display and the processor type and the OS version will display as below.



3. Double click on the Audacity\_for\_mac folder.



4. Then double click "audacity-macosx-ub-2.1.2.dmg".



Wait a few minutes until this window disappears.

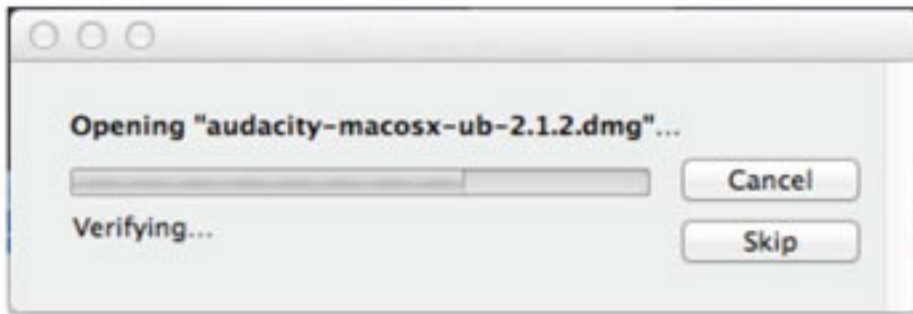

Then another window will appear.



Drag the "Audacity" folder in to "Applications" as the instruction show on the window.

5. Double click the Audacity folder and in the Audacity window, files will be displayed in the folder.



6. Double click the Audacity icon to start the software running, alternatively, drag the "orange ball wearing headphones" icon down onto the desktop toolbar. Click on this icon to run Audacity.

# CONFIGURING AUDACITY FOR MAC

## Audacity Interface for Mac

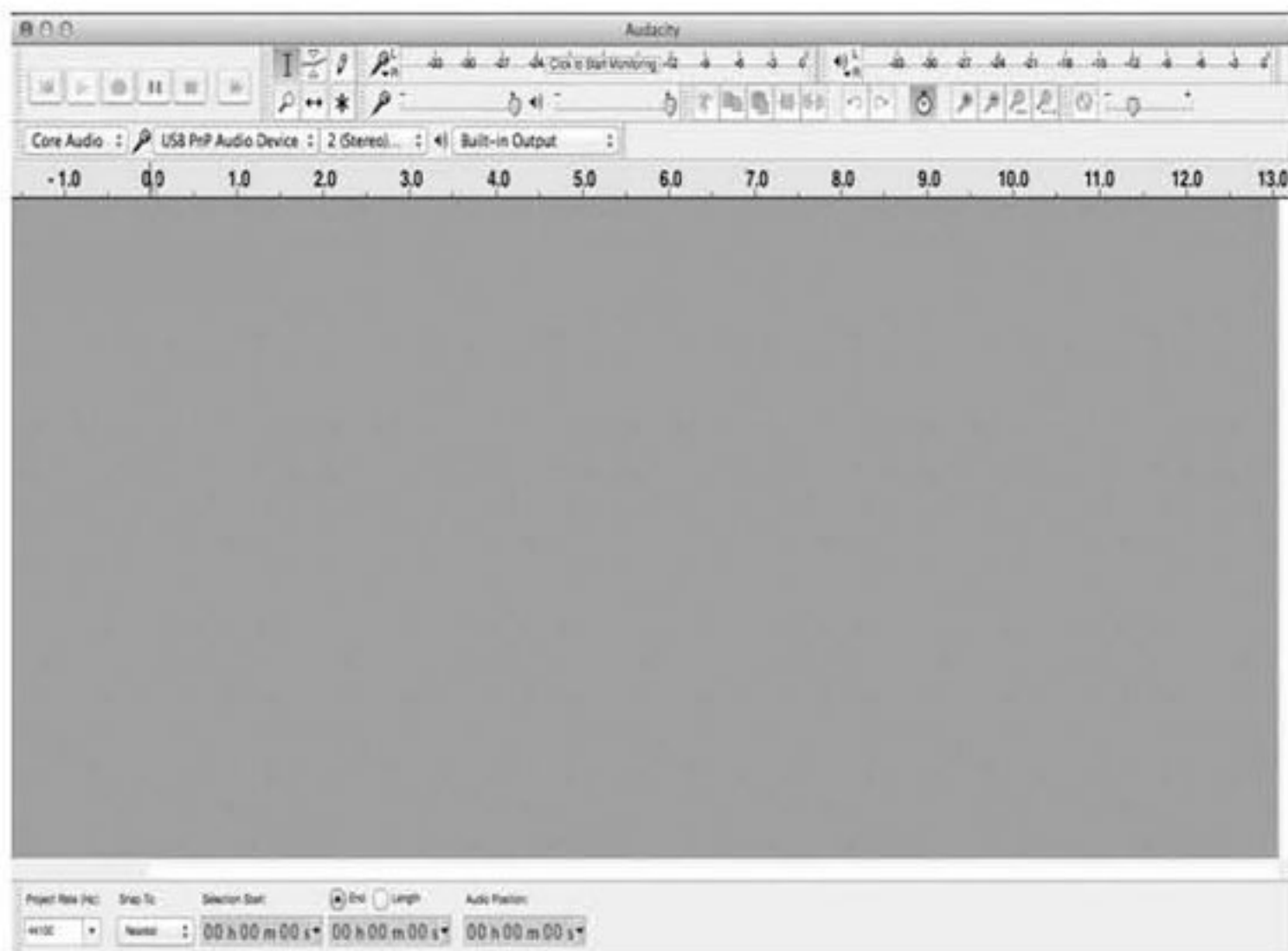



## Audacity Interface---Settings and controls

At the top of the main Audacity window, to the right of the play control buttons, you will see the input and output level meters (labeled L and R). Under the output level meter, is an icon that looks like a microphone. Next to the microphone is a black arrow that points down. Click this arrow and select Start Monitor. (If you do not see the input and output level meters, open your Preferences again as described above.)

# AUDACITY CONTROLS AND BUTTONS

Use the attribute control button at the top of the screen to go to Beginning, Play, Record, Pause, Stop and End. Use the File, Edit, View, Transport, Tracks, Generate, Effect and Analyze menus to Save, Export, and Edit the music.

1. Click the (  ) button to skip to start;
2. Click the (  ) button to play;
3. Click the (  ) button to record;
4. Click the (  ) button to pause the recording;
5. Click the (  ) button to stop the recording;
6. Click the (  ) button to skip to end;
7. Input level monitor
8. Output level monitor
9. Input device
10. Output device
11. Adjust the input volume.
12. Adjust the output volume.

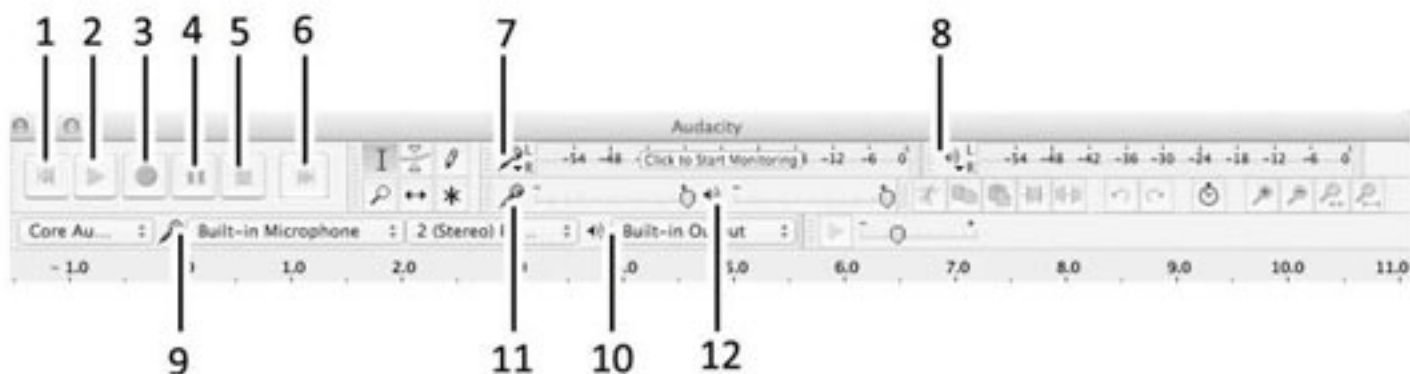



# AUDACITY PREFERENCES SETTINGS

A few settings will be required before you download the music.

1. Click "Audacity" on the Audacity interface, select "Preferences" and another window will appear on the screen.

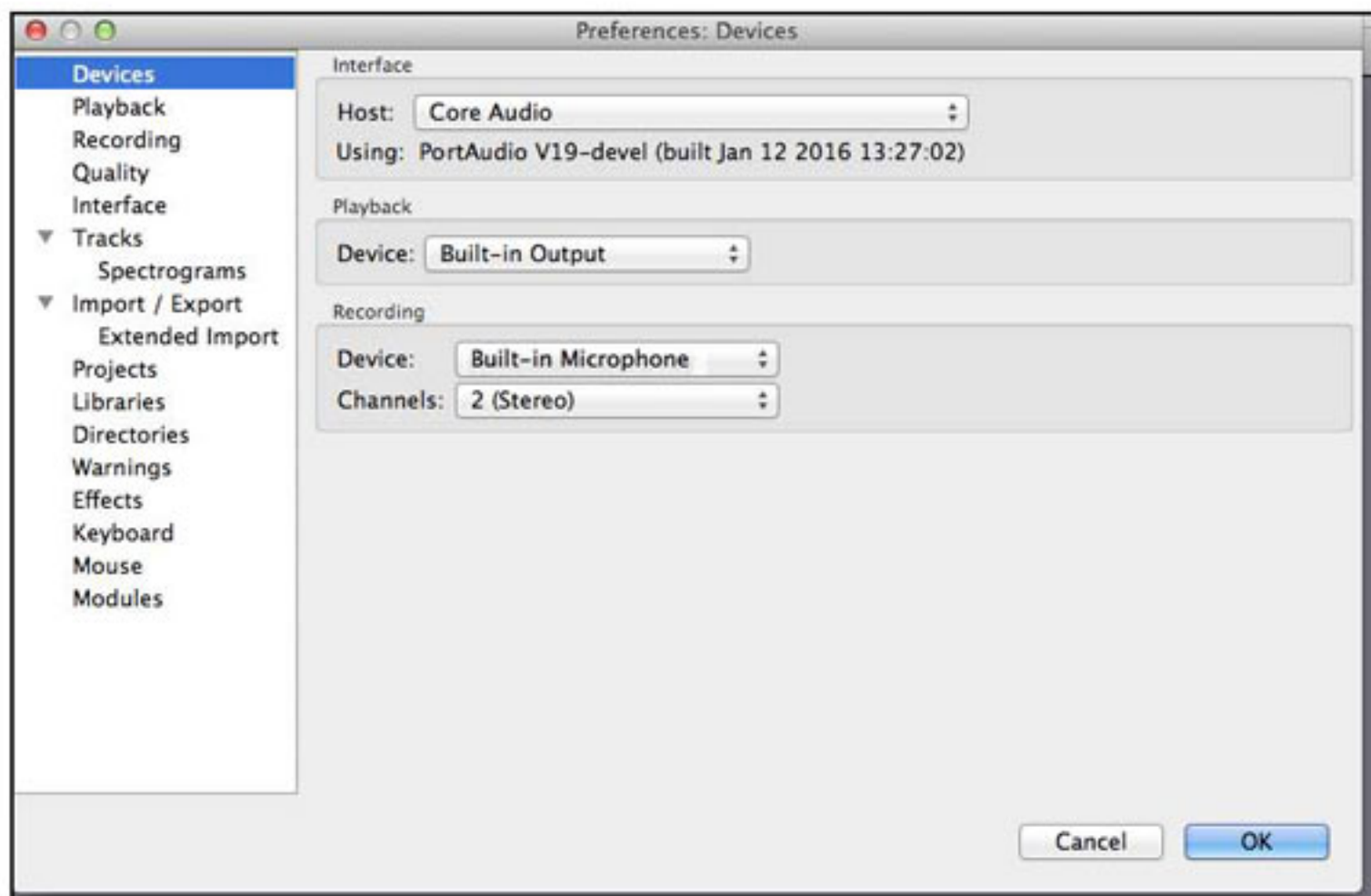

2. In the window of Audacity Preferences click "Devices" on the left hand side. Then on the right side within the Recording Device column, set Device to "USB PnP Audio Device", Channels to "2 (Stereo)".

NOTE: If you cannot find the "USB PnP Audio Device" in the Device list, close the Audacity Software and re-open and try again. Ensure that the turntable is connected to the computer.

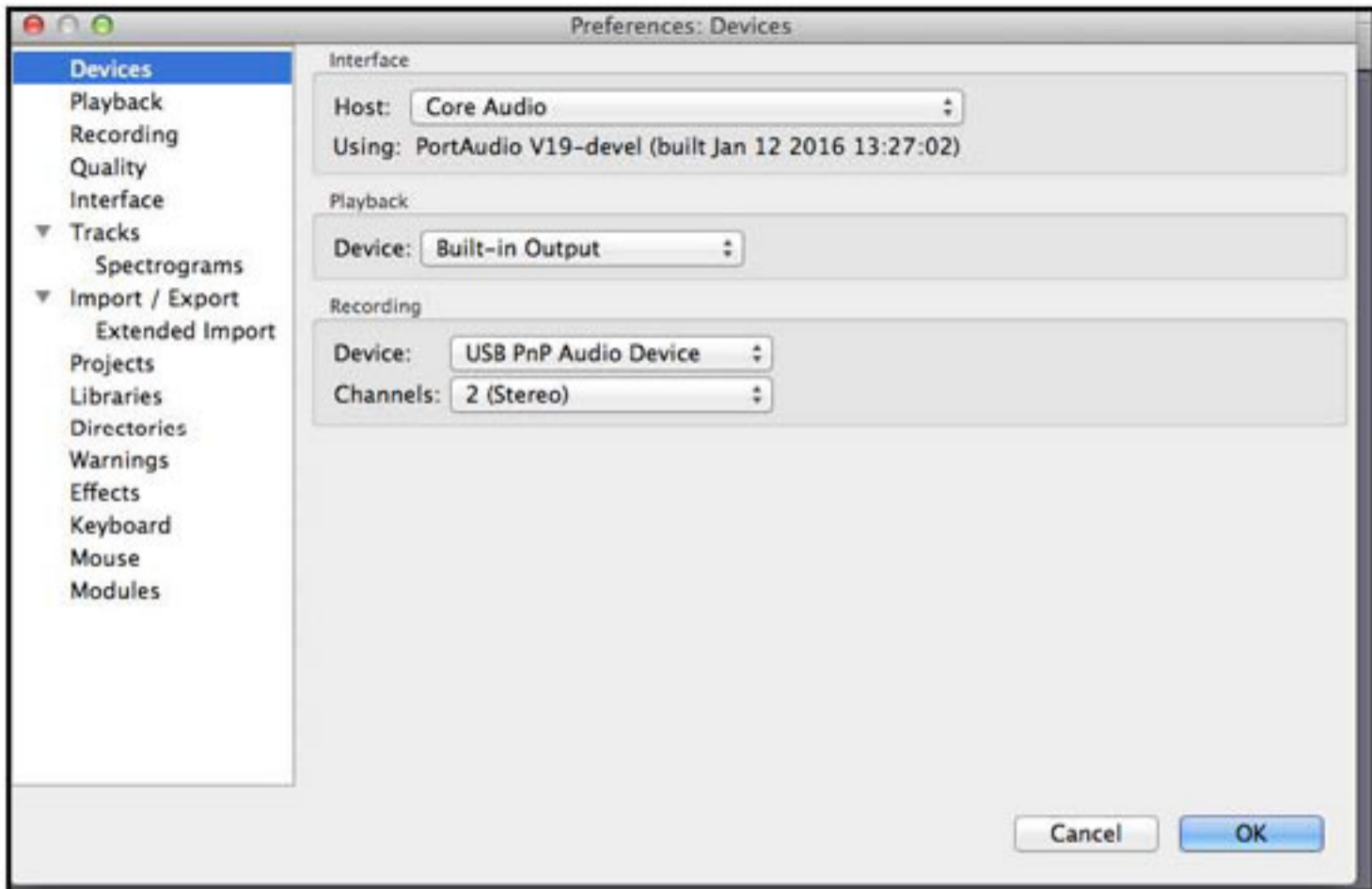

3. Click "Recording" on the left. Then on the right side in Playthrough column, click the checkbox beside "Software Playthrough: Listen while recording or monitoring new track". In the Sound Activated Recording column, click the checkbox beside "Sound Activated Recording", then slide the meter to -36 db. NOTE: Once the 'Sound Activated Recording' is selected, the Pause button will not work during recording.

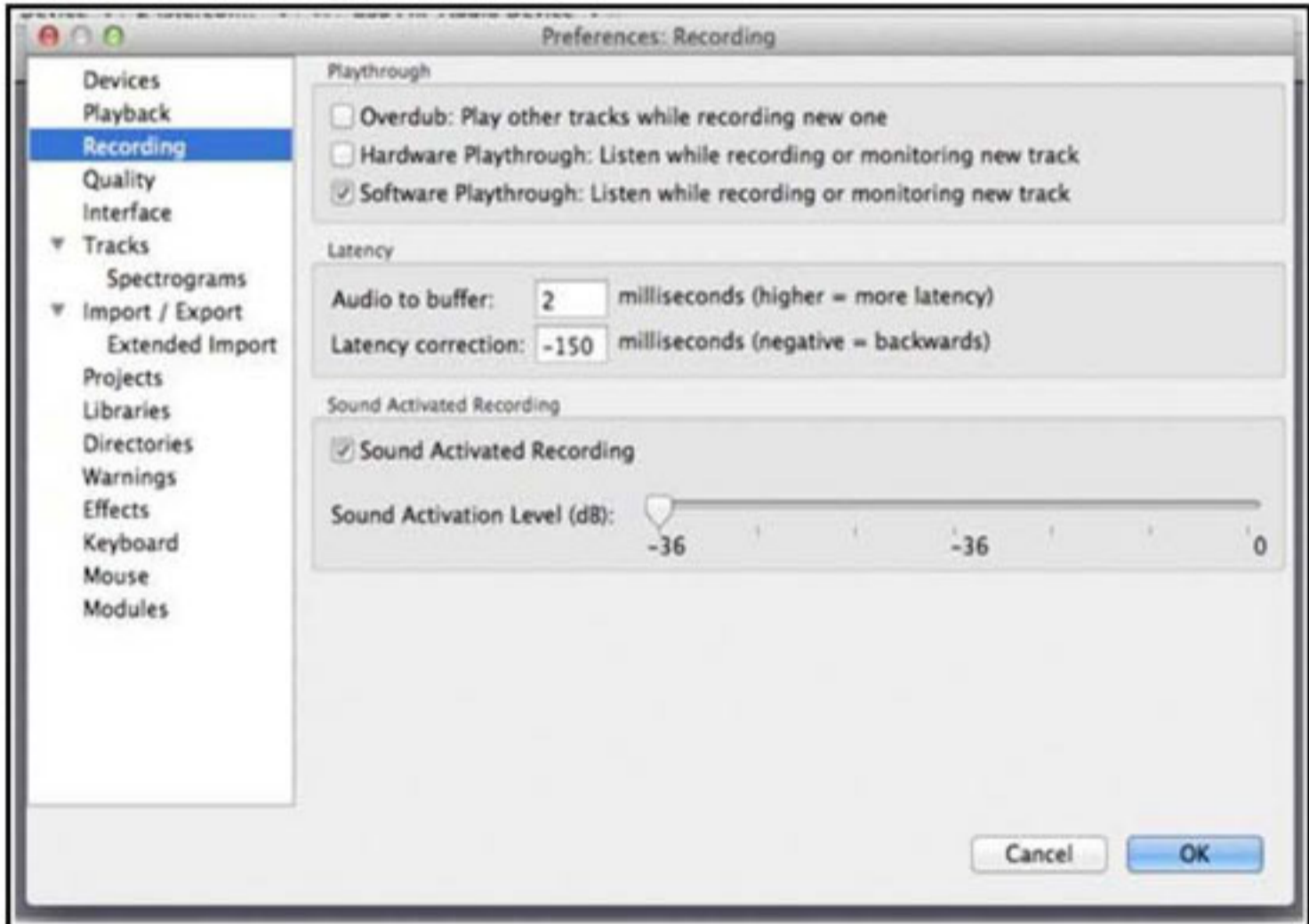

4. Click "Quality" on the left then on the right side in the Sampling column, select "44100 Hz" in Default Sample Rate and select "16-bit" in Default Sample Format.

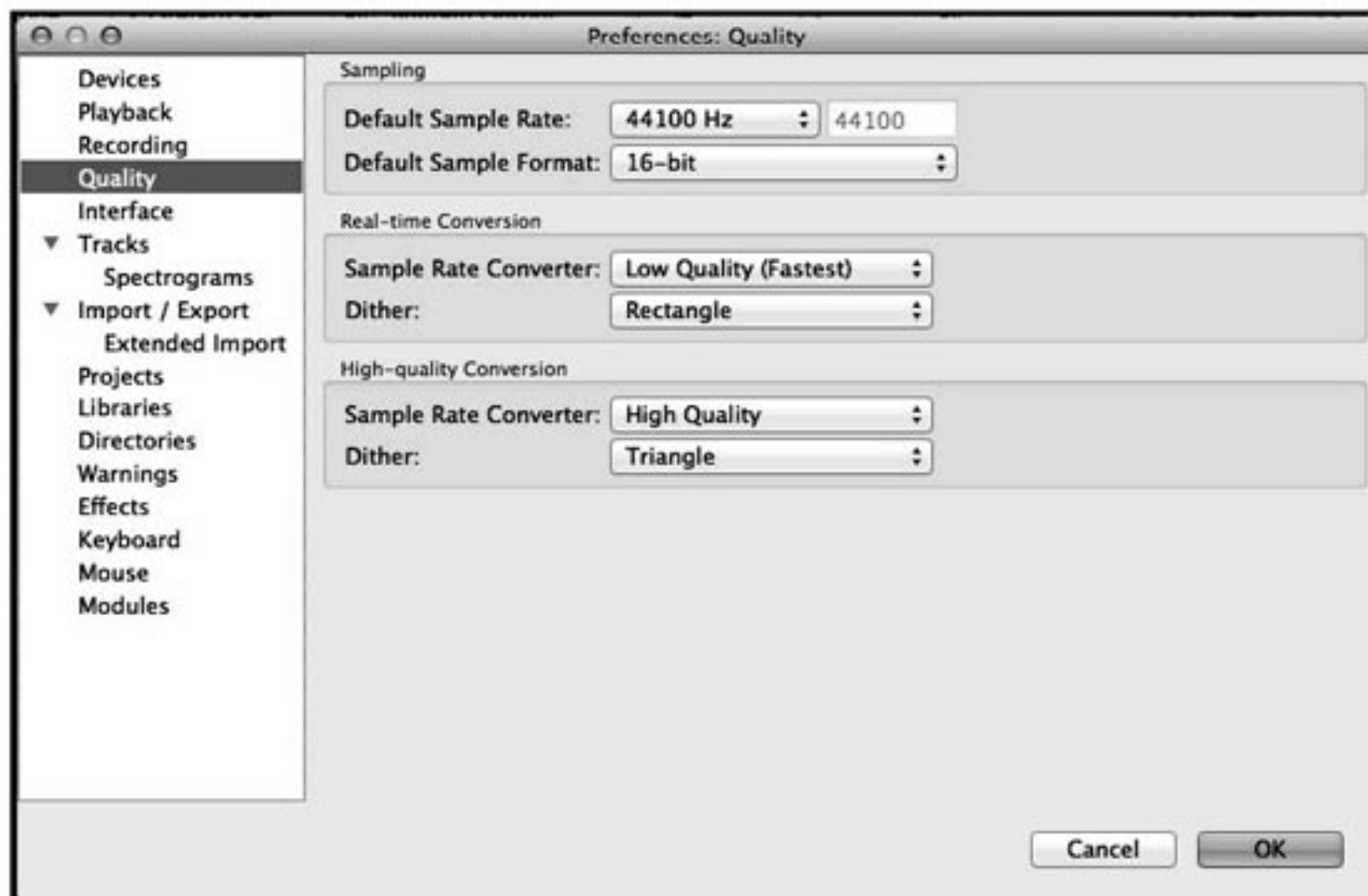

5. Click "Libraries" on the left then on the right side in MP3 Export Library column, check if the program has detected and shown the MP3 Library Version there. If shown, skip and forward to step 6.

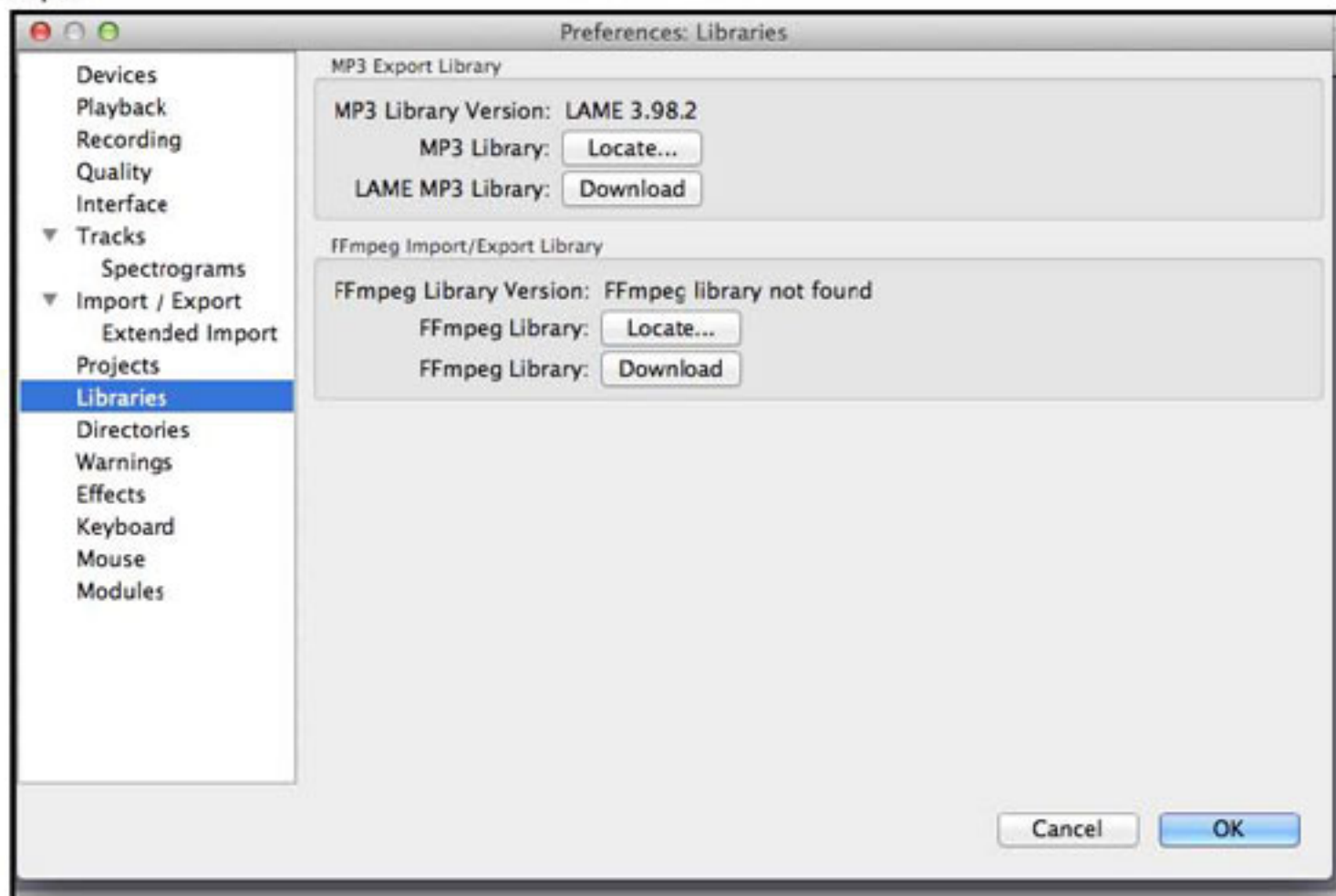

If "MP3 export library not found" is displayed, you must find the "LAME". Click "Locate..." button then a window named "Locate Lame" appears to find where the "LAME" is. Click the "Browse..." button to find it.

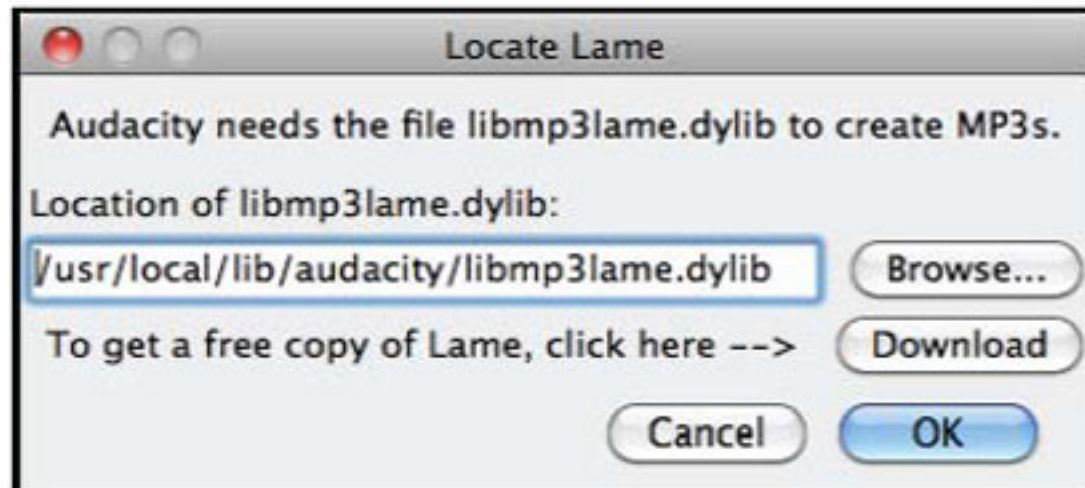

If you cannot find it or the LAME file you found is not compatible, click the "Download" button and a website will show automatically. Scroll down the webpage to find a title named "Mac OS X". Click the "LAME download page" and another website will show automatically.

#### Mac OS X

On OS X 10.6 or later, Administrative (and occasionally, root) permissions may be needed on some machines to read the LAME library the installer places in /usr/local/lib/audacity.  
In case of difficulty, please download the zip version "Lame\_Library\_v3.98.2\_for\_Audacity\_on\_OSX.zip" from "Alternative zip download for Lame 3.98.2" below and follow the instructions.

#### • Installer

1. Go to the external [LAME download page](#).
2. Download **Lame Library v3.98.2 for Audacity on OSX.dmg**
3. When you have finished downloading, double-click the .dmg to mount it, then go to the Finder (in Safari, the "Lame Library v3.98.2 for Audacity" virtual disk image will be extracted and mounted automatically after downloading).
4. Double-click "Lame Library v3.98.2 for Audacity.pkg", the standard OS X Installer will start.
5. Click through the steps in the Installer, accepting the defaults in all cases; this will install the LAME binary "libmp3lame.dylib" in /usr/local/lib/audacity.
6. Audacity should detect LAME automatically when you export as MP3. If Audacity cannot find LAME:
  1. Click **Audacity > Preferences** then choose "Libraries" on the left.
  2. Click "Locate..." under "MP3 Export Library", then "Browse..." in the "Locate Lame" dialog.
  3. The "Where is libmp3lame.dylib?" window will open at /usr/local/lib/audacity; select "libmp3lame.dylib", click "Open" then "OK" and "OK".

Find and Click the "MAC OSX downloads"

**Click Here, Windows User ----> Jump straight to [Windows downloads](#)**

**Click Here, MAC OSX User ----> Jump straight to [MAC OSX downloads](#)**

Scroll down the webpage.

## For FFmpeg and LAME on Mac OSX click below:

*If Audacity does not detect FFmpeg, download the ZIP option, extract the files inside to a well known folder, then open Audacity, go to Library Preferences and configure it to search on the well known folder you extracted the files to.*

**For Audacity 1.3.3 or later on Mac OS X 10.4 and greater (Intel or PPC), and Audacity 1.2.5 on OS X 10.4 and later (Intel)**

[Lame Library v3.98.2 for Audacity on OSX.dmg](#) (ZIP version [here](#))

**FFmpeg 2.2.2 ZIP for Audacity 2.0.6 or later on OS X 10.4 and later (Intel or PPC) (THIS IS NOT LAME!):**

[ffmpeg-mac-2.2.2.zip](#) - [DMG version here](#)

**FFmpeg Binary for Audacity 1.3.13 to 2.0.5 ONLY (see previous link for 2.0.6) OS X 10.4 and later (Intel or PPC):**

[FFmpeg \(0.6.2 OSX 10.4+ DMG\)](#) (zip version [here](#) or if problems with the installer, try [this new one](#))

You will notice a form showing the LAME for all version systems. Find a title named "For Audacity 1.3.3 or later on Mac OS X 10.4 and greater (Intel or PPC), and Audacity 1.2.5 on OS X 10.4 and later (Intel)" and then click "Lame Library v3.98.2 for Audacity on OSX.dmg" or "here" to download the file. Then locate LAME and click OK.

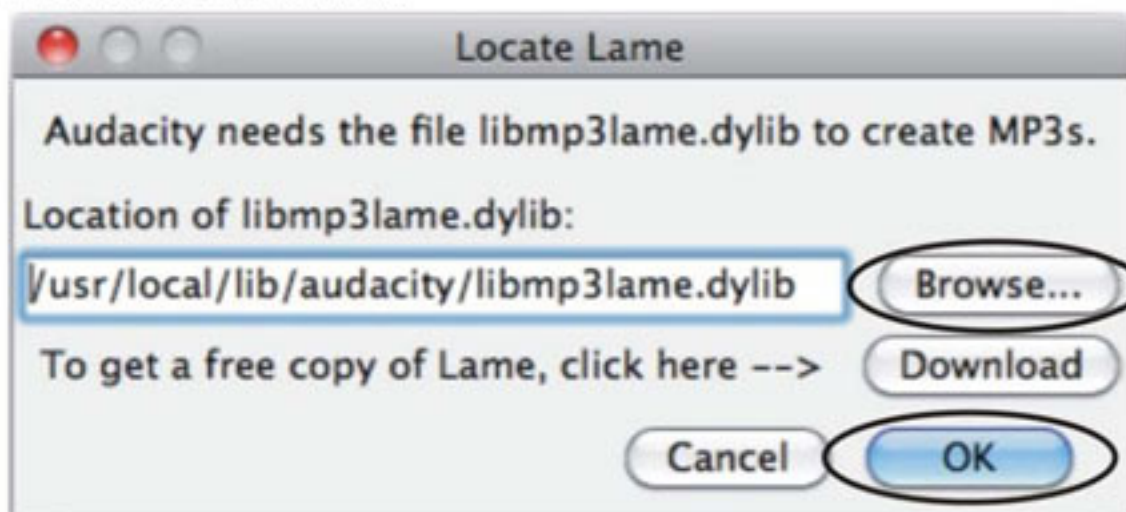

6. Click OK to close the Preferences interface.

## SETTING THE RECORDING INPUT LEVEL

It is recommended that the recording input level is adjusted prior to starting to record. Slide the output level to about 0.5, slide the input level to 0.3, then get your record ready.

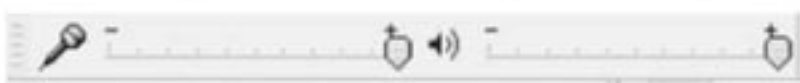



# RECORDING OPERATION

To download music and save into computer:

1. Place the record on the turntable.
2. Move the tone-arm over to the record to start playing.
3. Click the Record (  ) button to start recording.

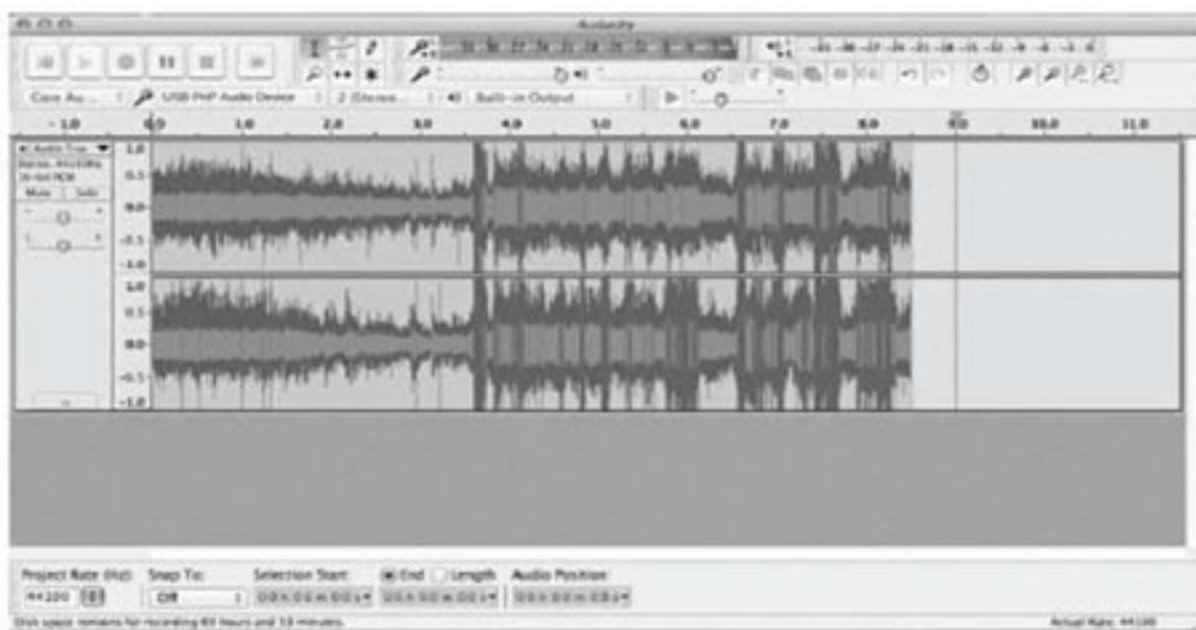
The waves (left and right tracks) will show on the interface.





4. At end of the song, click "pause" (  ) button on computer and press Stop button on turntable, move cursor to the wave area and left click at the end of the song.

For the next song, replace the album or move tone-arm to another desired song. Press Play button on the turntable to start playing the next song. Immediately press "pause" (  ) button on computer and downloading will continue and another R/L track will appear on the interface.

**NOTE:** Pause button will not work during recording process if the 'Sound Activated Recording' in the Preferences Recording is selected. Clear the checkbox next to the 'Sound Activated Recording' if you want to pause recording manually.

5. Repeat steps 3 and 4 until you have finished downloading.

**NOTE:** Do not click stop button on computer while continuously downloading songs. Remember to click pause button in between your desired songs. Press stop button on the computer only when all your desired songs have been downloaded.

After your have finished downloading, you may play back the songs through your computer. In stop mode, simply click (  ) SKIP button to start, then the (  ) PLAY button.

# DIVIDING TRACKS

1. Press (  ) button to return to the beginning of the first song.
2. Move cursor to the wave graphic area, left click the mouse and hold then drag from left to right. Release the mouse when the highlighter has reached the end of the first song.
3. Click "File" tab then select "Export Selected Audio...".
4. The window will pop up a dialog box for you to complete the Metadata. Click OK button when completed.



5. Then a window appears, select your music file location and format and type in your file name. Click "Save" and the song is now saved on the computer.

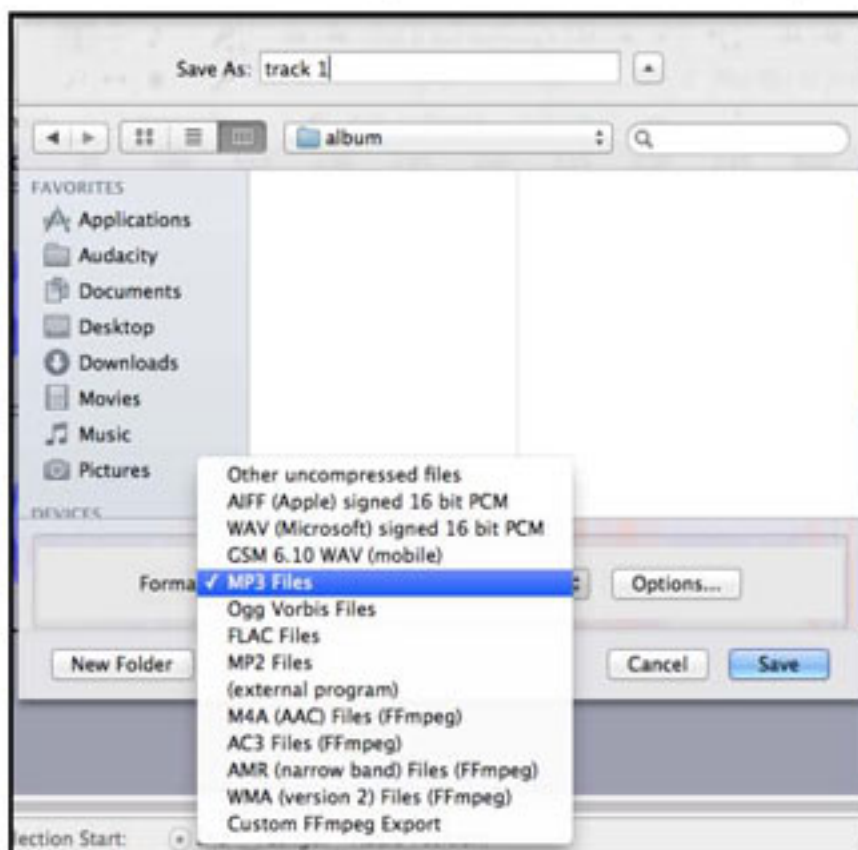

6. Edit Metadata window will appear. Complete the information then click OK. Wait for a few minutes until the saving is complete.

Tag	Value
Artist Name	
Track Title	
Album Title	
Track Number	
Year	
Genre	
Comments	



Buttons: Add, Remove, Clear

Genres: Edit..., Reset...

Template: Load..., Save..., Set Default

Buttons: Cancel, OK

## EXPORT AND SAVE FILES (AFTER RECORDING IS COMPLETED)

- When the recording is finished, click the (  ) on the screen and stop the cassette playback.
- You have a music download on your computer now.
- You may play back the song through your computer.
- Simply click the (  ) to play.



1. To export and save individually, click the "File" tab on the Audacity window then select "Export Selected Audio...".



- To export and save into one file, click the "File" tab on the Audacity window then select "Export Audio".



- A window will pop up after clicking Export. It will default to the MP3 format, but you also can select other formats by clicking the arrow located at the right of the MP3 Files.

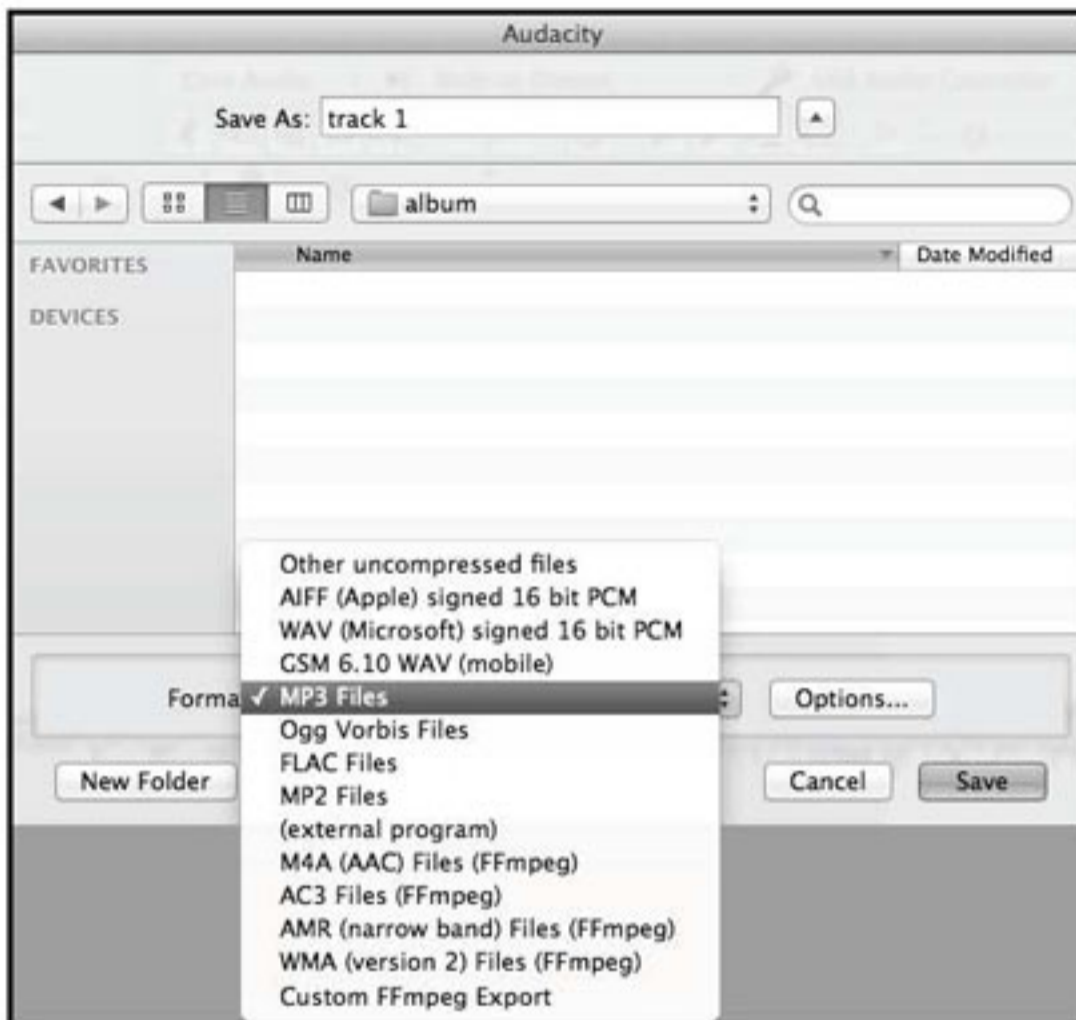

- Complete the "Save As" and Save-in location, click the Save button and the Edit Metadata window will display. Complete the information if necessary then click OK and wait a few minutes until it is finished saving.

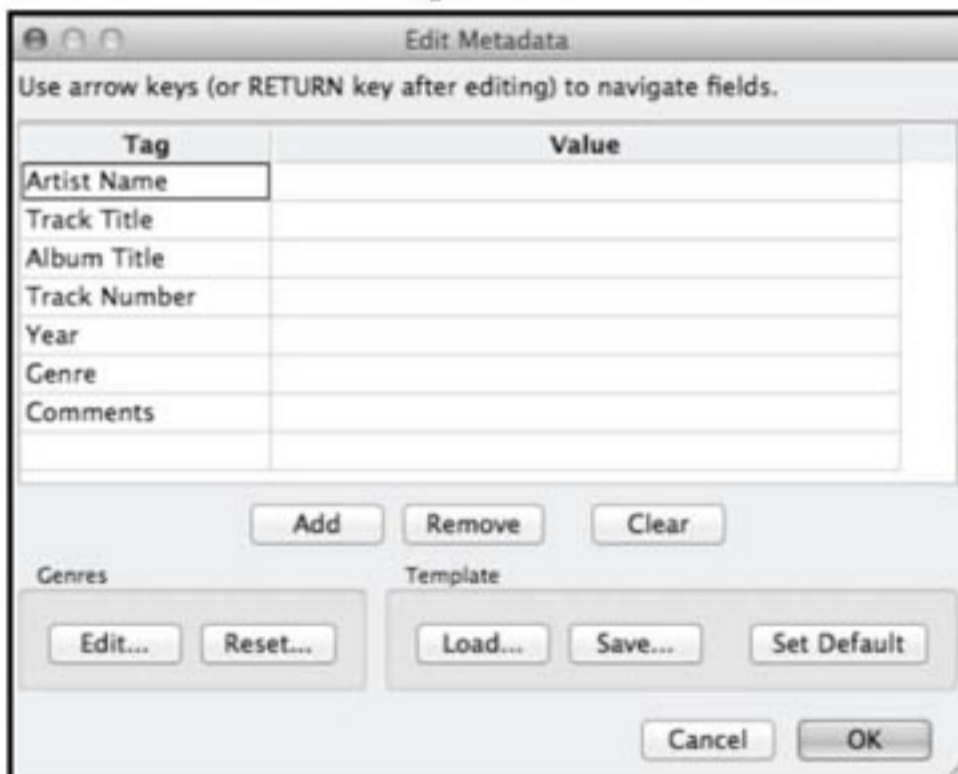



## TROUBLESHOOTING GUIDE

If you experience any problems with your unit, kindly consult the following guide prior to calling your dealer.

### NO SOUND:

- If you are not getting any sound into the software application, go back to the preferences as shown above and make sure that you have selected the USB PnP Audio Device for the recording device in the devices.
- Power Cycle: Close Audacity, turn off the turntable, unplug the USB Cable, then plug in the USB Cable, turn on the turntable and reopen Audacity.
- If you are not able to hear any audio as you play the record, please click on the microphone drop-down arrow and select Start Monitoring. This will enable you to hear the audio from the turntable, even if you have not record-enabled the Audacity application.

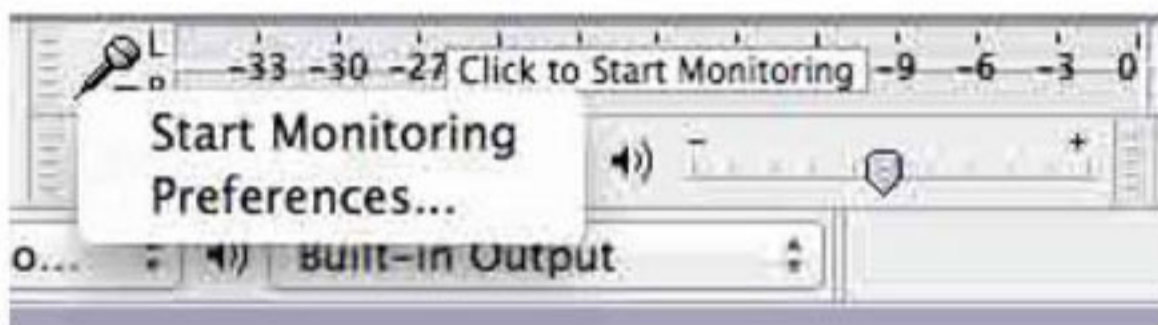

Check the microphone slider to make sure that it is at full volume, all the way to the right as shown below. If you find the recording sounds low or distorted, adjust the microphone slider.



- If you still do not have the fluctuating wave on the interface during recording, or the recording sounds unsatisfactory, adjust the recording volume as follows:

Click the launchedpad icon



Then find "System Preference" and double click it.



In the new interface, find the "Sound" icon and double click it.



Adjust the Output volume under "Sound Effects"

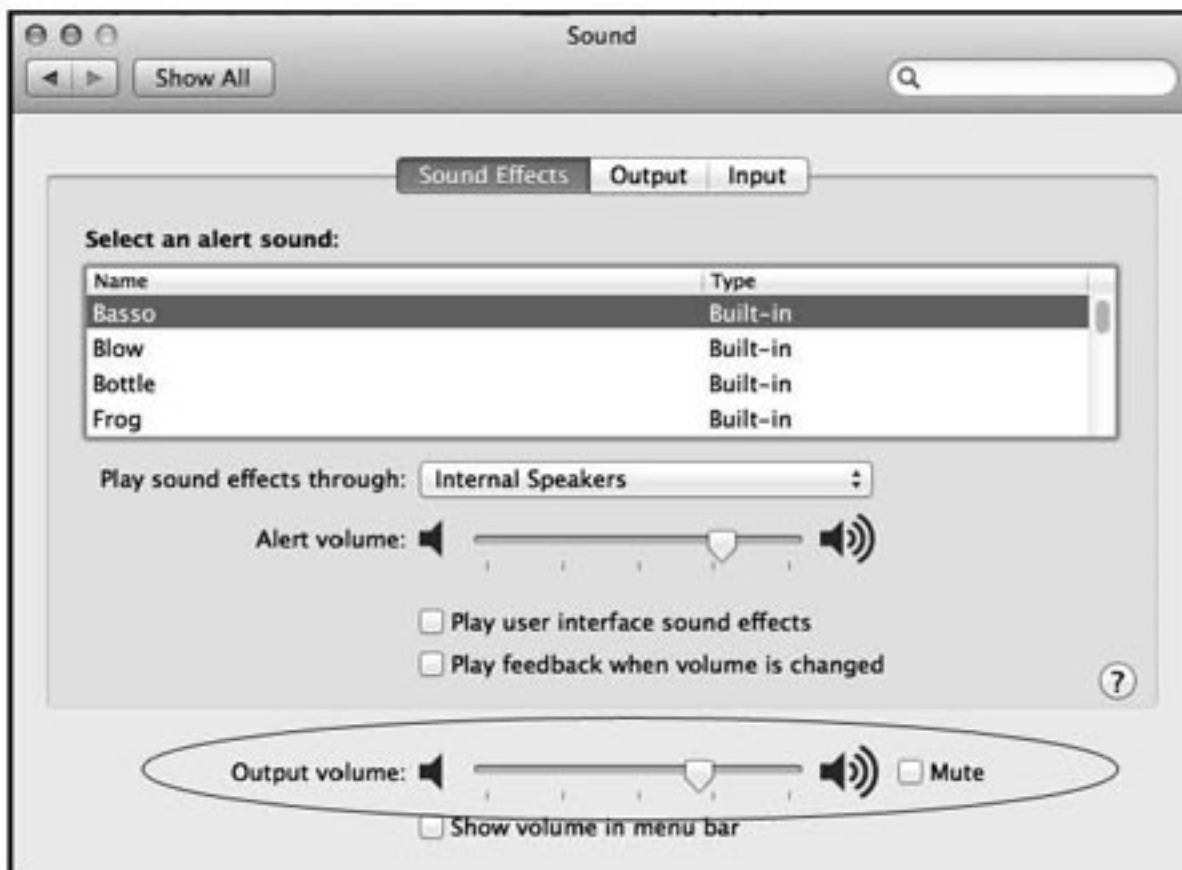

Under "Input", select "USB PnP Audio Device" and adjust the "Input volume"

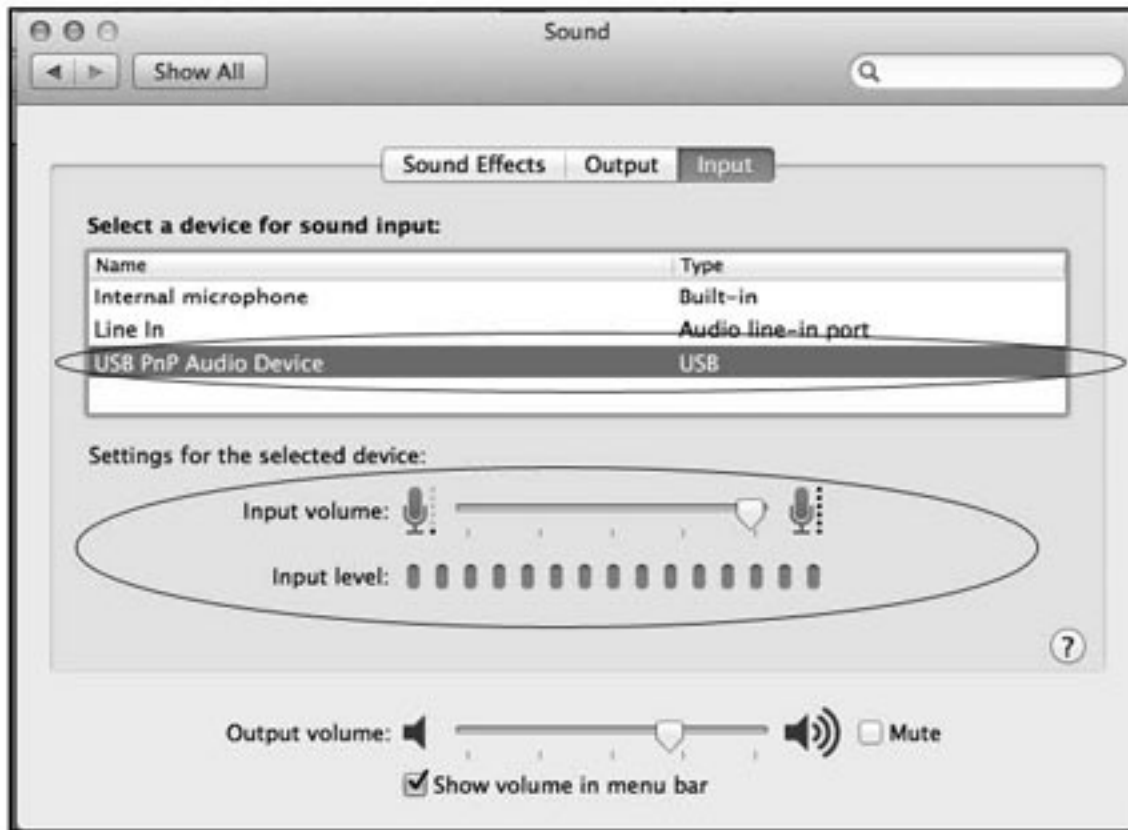

### POOR SOUND QUALITY:

- Check your stylus to make sure it is secured to the tone arm. The stylus must be connected to the tone arm whenever using the turntable.
- Make sure that your RCA plugs are plugged into a source or not touching bare metal. If you are experiencing noise through the USB, you may have interference from the RCA plugs. Ensure the USB cable is not touching or near any other cables.
- If you experience any odd sounds coming from the recording, try closing all applications and restarting the computer. Only run Audacity while recording.

## Specifications

### GENERAL

Power Requirements.....	AC 120 V ~ 60 Hz
Power Consumption.....	19 W
Dimensions(L x Wx H).....	360 x 345 x 165 mm / 14.2 x 13.6 x 6.5 in (approx.)
Weight.....	11.7 lbs. (approx.)

### AMPLIFIER

Output Power.....	2.0 W + 2.0 W
Frequency Response.....	60 TO 20,000 Hz

### SPEAKER SYSTEM

Type.....	1-way
Impedance.....	8 ohms
Input Power.....	Max. 3 W

### FM/AM RADIO

FM Frequency Range.....	88 to 108 MHz
AM Frequency Range.....	530 to 1710 KHz

### CD PLAYER

Frequency Response.....	60 to 20, 000 Hz +/-4 dB
Signal-to-Noise Ratio.....	55 dB (IEC-A)

### RECORD PLAYER

Motor.....	DC servo motor
Drive System.....	Belt Drive
Speeds.....	33-1/3 rpm, 45 rpm and 78 rpm
Wow &Flutter.....	Less than 0.25% (WTD)
S/N Ratio.....	More than 50 dB
Cartridge Type.....	Ceramic Stereo Cartridge
Stylus.....	ITRRS-300

### BLUETOOTH

Bluetooth Version.....	Bluetooth V2.1+EDR
Bluetooth Profiles.....	A2DP, AVRCP
Bluetooth Frequency Range.....	2.402GHz-2.480GHz
Operating Distance.....	10 meters (33 ft.)

### USB

Type.....	USB series B connector
Recording.....	USB to PC record for vinyl record
Full-speed.....	USB 2.0 full speed

## Troubleshooting Guide

In case of trouble with the unit, please look through this chart and see if you can solve the problem by yourself before calling your dealer.

		Cause	Solution
GENERAL	Power does not come on when the power switch is pressed.	-Unit is unplugged.	-Connect the unit to the AC power supply.
	No sound comes out of the speakers.	-The volume is turned down (to MIN).  -The input selector does not match the playback source.	-Adjust the volume.  -Re-select the desired input source.
	The sound is noisy.	-The unit is too close to a TV set or another similar appliance.	-Turn off the TV or other appliance, and relocate the unit.
RADIO	Cannot listen to any station, or signal appears weak.	-The station is not tuned-in properly.  -A TV set is being used nearby and is interfering with the radio reception.	-Properly tune-in the desired station.  -Turn-off the interfering TV set.
	The sound is distorted.	-The antenna is not oriented properly.	-Re-orient the antenna until reception improves.
CD PLAYER	CD stops immediately after starting, or unit pauses or stops during play.	-The CD is inserted upside down.  -The CD is dusty or dirty or there is condensation on the CD.	-Insert the CD with the printed side right-side up.  -Carefully clean and dry the CD.
	No sound.	-The CD player is paused.	-Press the PLAY/PAUSE button.
	Specific CD is noisy, or playback stops or skips.	-The CD is scratched, damaged or warped.  -The disc is very dirty.	-The CD should be changed.  -Carefully clean the CD.

BLUETOOTH	No sound.	<ul style="list-style-type: none"> <li>-The unit does not switch to Bluetooth mode.</li> <li>-Your device's and/or the unit's volume is not turned up.</li> <li>-Your device is too far from the unit or there is some obstacle between your device and the unit.</li> </ul>	<ul style="list-style-type: none"> <li>-Ensure the unit is switched to BT mode.</li> <li>-Move your Bluetooth device closer to unit.</li> <li>-Turn up the volume on your portable device and/or the unit.</li> <li>-Turn off your Bluetooth device and unit, then power them both back on.</li> </ul>
	Sound is garbled.	<ul style="list-style-type: none"> <li>-Your device's and/or the unit's volume is not adjusted properly.</li> </ul>	<ul style="list-style-type: none"> <li>-Turn down the volume on your device/phone and the unit.</li> </ul>
	Unable to pair with a Bluetooth device.	<ul style="list-style-type: none"> <li>-Your device doesn't have Bluetooth connectivity.</li> <li>-The Bluetooth pairing is not successful.</li> </ul>	<ul style="list-style-type: none"> <li>-Confirm that your device is Bluetooth compatible.</li> <li>-Repair the unit and device again.</li> </ul>



USB-PC RECORDING	No sound.	<ul style="list-style-type: none"> <li>-Have not selected the USB PnP Audio Device for the recording device in the devices.</li> <li>-Microphone slider is not at full volume</li> </ul>	<ul style="list-style-type: none"> <li>-Go back to the preferences as shown above and make sure that you have selected the USB PnP Audio Device for the recording device in the devices.</li> <li>-Close Audacity, turn off the turntable, unplug the USB Cable. Then plug in the USB Cable, turn on the turntable and reopen Audacity.</li> <li>-Please click on the microphone drop-down arrow and select Start Monitoring.</li> <li>-Adjust the microphone slider.</li> </ul>
	Poor sound quality	<ul style="list-style-type: none"> <li>-The stylus is not connected to the tone arm</li> <li>-USB cable is near any other cable</li> </ul>	<ul style="list-style-type: none"> <li>-Check your stylus to make sure it is secured to the tone arm.</li> <li>-Ensure the USB cable is not touching or near any other cables.</li> </ul>
PHONO	Decline in turntable audio performance.	-The turntable stylus is worn out.	-Replace the stylus.

For further assistance with your product, call Innovative Technology at TOLL FREE# 1-877-ITECH-97 (1-877-483-2497).

## FCC Statement

This device complies with Part 15 of the FCC Rules. Operation is subject to the following two conditions: (1) This device may not cause harmful interference, and (2) this device must accept any interference received, including interference that may cause undesired operation.

NOTE: This equipment has been tested and found to comply with the limits for a Class B digital device, pursuant to Part 15 of the FCC Rules. These limits are designed to provide reasonable protection against harmful interference in a residential installation. This equipment generates uses and can radiate radio frequency energy and, if not installed and used in accordance with the instructions, may cause harmful interference to radio communications. However, there is no guarantee that interference will not occur in a particular installation. If this equipment does cause harmful interference to radio or television reception, which can be determined by turning the equipment off and on, the user is encouraged to try to correct the interference by one of the following measures:

- Reorient or relocate the receiving antenna.
- Increase the separation between the equipment and receiver.
- Connect the equipment into an outlet on a circuit different from that to which the receiver is connected.
- Consult the dealer or an experienced radio/TV technician for help.

WARNING: Any changes or modifications not expressly approved by the party responsible for compliance could void the user's authority to operate this equipment.

The device must not be co-located or operating in conjunction with any other antenna or transmitter.

This device complies with FCC and IC radiation exposure limits set forth for an uncontrolled environment. The device should be installed and operated with a minimum distance of 20cm between the radiator and your body.

## INDUSTRY CANADA

This device complies with RSS247 of Industry Canada. Cet appareil se conforme à RSS247 de Canada d'Industrie. This device complies with Industry Canada license-exempt RSS standard(s). Operation is subject to the following two conditions: (1) this device may not cause interference, and (2) this device must accept any interference, including interference that may cause undesired operation of the device. appareils radio exempts de licence. Son fonctionnement est sujet aux deux conditions suivantes: (1) le dispositif ne doit pas produire de brouillage préjudiciable, et (2) ce dispositif doit accepter tout brouillage reçu, y compris un brouillage susceptible de provoquer un fonctionnement indésirable.

Radiation Exposure Statement: The product complies with the Canada portable RF exposure limit set forth for an uncontrolled environment and are safe for intended operation as described in this manual.

The further RF exposure reduction can be achieved if the product can be kept as far as possible from the user body or set the device to lower output power if such function is available.

## CALIFORNIA PROP 65 WARNING

"WARNING" This product contains chemicals known to the State of California to cause birth defects or other reproductive harm. For more information on these regulations and a list of chemicals, log on the following website address:

<http://www.oehha.ca.gov/prop65.html>

**Innovative Technology Electronics Corp.**

**Limited Warranty: 90 Days Labor, One Year Parts**

Innovative Technology Electronics Corp. (IT) warrants the product to be free from "Defects" in materials under normal use for a period of "One Year" from the date of the original purchase. The Warranty is "Not" transferable. IT agrees, within the initial "90 Day" period, to repair or replace the product if it is determined to be defective at "No Charge". It is further agreed that IT will cover the cost to repair or replace damaged "Parts" only for a total period of "One Year" from the date of the original purchase. The warranty does not cover cosmetic damage, antennas, AC cords, cabinets, headbands, ear-pads, or damage due to line power surges, connection to improper voltage supply or settings, misuse, mishandling, accident, acts of God or attempted repair by an unauthorized service agent. **To obtain service, the purchaser MUST present an original sales receipt / proof of purchase. Please contact us at [www.ithomeproducts.com](http://www.ithomeproducts.com) to request an RMA (Return Material Authorization) number to return products for service or replacement.** Returns without an RMA number on the package will be refused and returned to sender. Upon receipt of the returning item and our full inspection (IT) may issue a replacement to customer for the same item or of one that has equivalent value and features. To return an item, supply full name, return address, phone number, item purchased, receipt of purchase and reason for return to obtain RMA number. All returns must be in the original packaging or reasonable substitute to prevent damage. Customer "Must" include full name, shipping address and telephone number inside of package. No return will be shipped back to a PO Box or APO address.

Please include your check or money order in the amount of

- **USD\$5.00 for items \$10.00 to \$39.99 (Price Paid Per Unit)**
- **USD\$10.00 for items \$40.00 to \$99.99. (Price Paid Per Unit)**
- **USD\$16.00, for items \$100.00 and up. (Price Paid Per Unit)**
- **Shipping fees are non-refundable**

to be payable to Innovative Technology Electronics Corp.(for handling and return shipping charges) (IT) will not be responsible for delays or unprocessed claims resulting from a purchaser's failure to provide any / all of the necessary information.

Send all inquiries or RMA request via our website [www.ithomeproducts.com/support](http://www.ithomeproducts.com/support).

Innovative Technology Electronics Corp.

1 Channel Drive

Port Washington, NY 11050

Toll free: 1-877-483-2497

**Website for support: [www.ithomeproducts.com/support](http://www.ithomeproducts.com/support)**

There are no express warranties except as listed above.

REPAIR OR REPLACEMENT AS PROVIDED UNDER THIS WARRANTY IS THE EXCLUSIVE REMEDY OF THE CUSTOMER, (IT) SHALL NOT BE LIABLE FOR ANY INCIDENTAL OR CONSEQUENTIAL DAMAGES FOR BREACH OF ANY EXPRESS OR IMPLIED WARRANTY ON THIS PRODUCT EXCEPT TO THE EXTENT PROHIBITED BY APPLICABLE LAW. ANY IMPLIED WARRANTY OF MERCHANTABILITY OR FITNESS FOR A PARTICULAR PURPOSE ON THIS PRODUCT IS LIMITED IN DURATION TO THE DURATION OF THIS WARRANTY.

Some states do not allow the exclusion or limitation of incidental or consequential damages, or limitations on how long an implied warranty lasts, so the above exclusions or limitations may not apply to you. This warranty gives you specific legal rights and you may also have other rights, which vary from state to state.

Please note: As a result of continual improvements, the design and specifications of this product are subject to change without notice.

Victrola is a registered trademark of Innovative Technology Electronics Corp.

Bluetooth is a registered trademark of Bluetooth SIG, Inc.

Other trademarks and trade names are those of their respective owners.

Made in China.