

**UWP75D-1M12V (Product No.: 102200440101)**

**Summary**

UWP75 D-1M12V is a dimming driver that can provide constant voltage output. Complies with DALI standard protocol IEC 62386. LED driver featuring the dimming by DALI master/Touch DIM(PushDIM) switch, with smooth dimming curve and are flicker free.

**Product Feature**

- Single channel output with 12V CV direct current
- Wide voltage input range from 100VAC to 240VAC
- With built-in active PFC function
- Meet DALI protocol IEC 62386-207
- Support Touch DIM(Push DIM) function
- Ultra-thin design, Waterproof level IP67, High efficiency up to 85%
- Dimming effect smooth, no flicker
- Protections: Short circuit, over load, over voltage, lightning protection
- Suitable for LED CV lighting, such as LED module, LED strip light, LED tube, and so on



**Application**



**Technical Parameters**

Model	UWP75D-1M12V	
Input	Efficiency	85%@230VAC, Full load
	Voltage	100VAC-240VAC
	Frequency	50-60Hz
	Power Factor	>0.95@230VAC, Full load
	THD	<10%230VAC, Full load
	Standby power	<0.5W
	Current	1Amax@100VAC
	Inrush Current	Cold start 50A(measured50% lpeak twidth=60us) @230VAC
Output	Direct voltage	12VDC
	Rated current	6.25A
	Rated Power	75W
	Voltage Tolerance	±2%
	Over voltage protection	13-18VDC
	Ripple and noise(max)	<120mVp-p
	Channel	1
Protection	Short Circuit	Close output, recovers automatically after fault removed
	Over Voltage	Colse output recovers automatically of fault after restart
	Over Load	Hic cup recovers after fault condition is removed
Safety&EMC	Surge	L-N: 2kV,L,N-PG:4kV
	Withstand Voltage	I/P-O/P:3000VAC/5mA I/P-PG:1500VAC/5mA O/P-PG:500VAC/5mA
	Safety Standards	IEC/EN61347-1, IEC/EN61347-2-13, GB19510.1, GB19510.14
	EMC Eission	EN50515, EN61000-3-2 Class C, IEC61000-3-3, GB/T17743
	EMC Immunity	EN61000-4-2,3,4,5,6,8,11 EN61547,GB17625.1
Function	Dimming mode	DALI/Touch DIM(Push DIM)
	Dimming range	0.1%-100%
	DALI standard	IEC62386-101, IEC62386-102, IEC62386-207
Others	Working Temp.	-25°C~+50°C
	Storage Temp.; Humidity	-40°C-85°C, 20-90%RH
	Tc	90°C
	Material	Metal
	IP Rating	IP67
	Lifetime	50,000h@tc:85°C
	Warranty Condition	5 years
	Switch Cycle	>25,000 times
	Packing Size	Net weight: 820g±5%/PCS; 20PCS/Carton; 17kg±5%/Carton; Carton Size: 325*315*195mm (L*W*H)
	Dimension	270*61*25mm(L*W*H)

**Dimension(mm)**

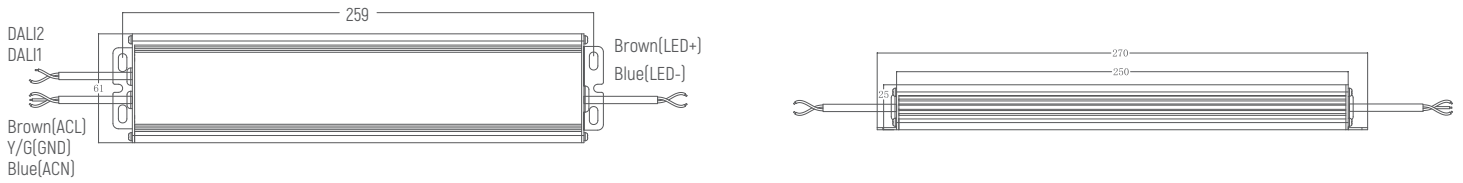

**Wiring Diagram**

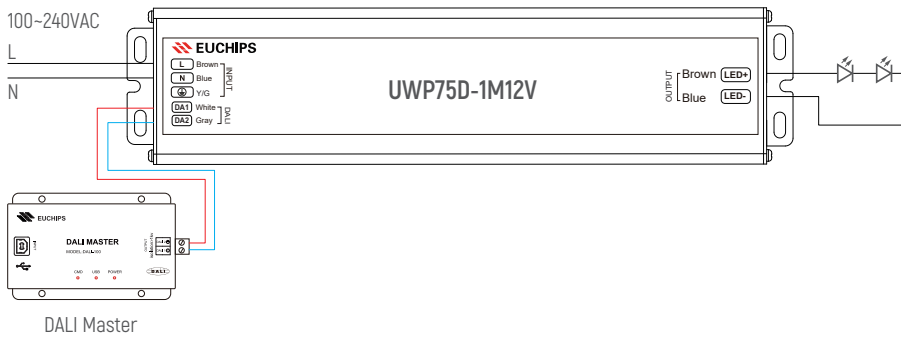

**Dimming Curve**

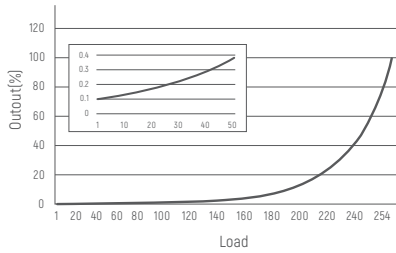

**Derating Curve**

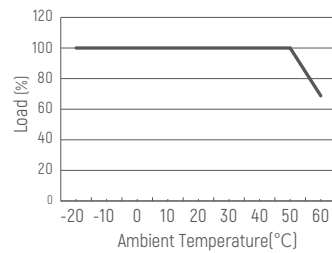

**PF vs Load**

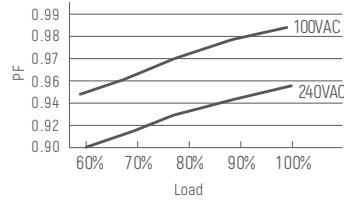

**Efficiency vs Load**

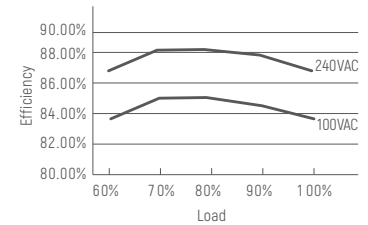

**DALI Diagram**

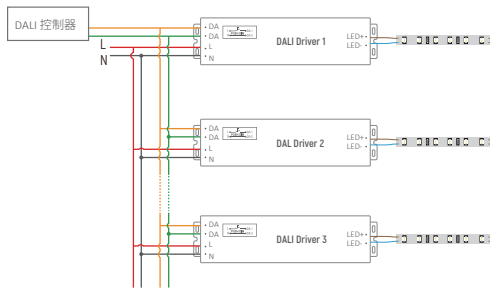

**Touch DIM(Push DIM) Diagram**

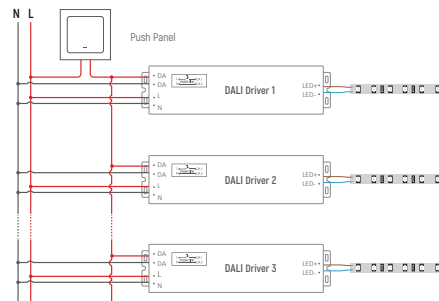

Remark: Only use open push button without indicator light. Maximum cable length between each Unit: 20 meters.

**Touch Dim(Push DIM) Function**

1. Press the Touch DIM switch for 8s or more, the driver can be controlled via Touch DIM switch.
2. Short press the Touch DIM switch (<0.5s) to control the lamp on or off.
3. Long press the Touch DIM switch (>0.5s) to dim the brightness of light. The dimming direction will change every time after pressing switch.
4. Double-click the Touch DIM switch (<0.3s), then all lamps connected on the device will be set maximum brightness.
5. The brightness adjustment range is 1%-100%, and the light can be turned off through short pressing when doing the adjustment with long pressing Touch DIM switch.
6. With the Power off memory function, the power-down state will be recovered when power on again.

※ The contents of this manual are updated without prior notice. If the function of the product you are using is inconsistent with the instructions, the function of the product shall prevail. Please contact us if you have any questions.

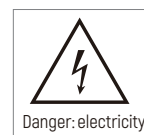
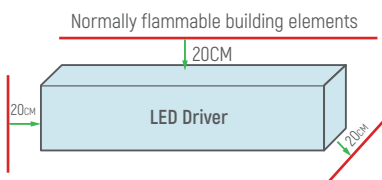

The external flexible cable or cord of this luminaire cannot be replaced; if the cord is damaged, the luminaire shall be destroyed; Dimming circuit (FELV circuit) shall be insulated from the input by basic insulation; Dimming circuit (FELV circuit) shall be insulated from the output by supplementary insulation; Dimming circuit (FELV circuit) shall be insulated from the earthed conductive parts by functional insulation.

Instructions shall be provided with controlgear that have FELV control terminals that state the following:  
Warning: FELV terminals marked "Risk of electric shock" are not safe to touch.  
Warning: Circuits connected to any FELV control terminal shall be insulated for the LV supply voltage of the controlgear and any terminals connected to the FELV circuit shall be protected against accidental contact.

UWP75D-1M12V (产品代码: 102200440101)

**概述**

UWP75D-1M12V是一款可提供恒压输出的调光驱动器符合DALI标准协议IEC62386。用DALI主控/Touch DIM(PushDIM)开关调光，曲线平滑、无闪烁。

**产品特点**

- 单通道恒压直流12V输出
- 宽电压输入范围100VAC-240VAC
- 宽电压输入含主动PFC, 足功率输出
- 遵循DALI协议标准 IEC62386-207
- 支持Touch DIM(Push DIM)功能
- 超薄设计, 防水等级IP67, 效率高达85%
- 平滑调光效果, 无间隔
- 保护: 防雷, 短路保护, 过载保护, 过压保护
- 适用于LED恒压灯具, 如LED模组, 灯带, 灯条等



**应用**



**技术参数**

产品型号	UWP75D-1M12V	
输入	效率	85%@230VAC, 满载
	电压	100VAC-240VAC
	频率	50-60Hz
	功率因素	>0.95@230VAC, 满载
	THD	<10%230VAC, 满载
	待机功耗	<0.5W
	电流	1Amax@100VAC
	浪涌电流	冷启动50A[50% Ipeak 下测试twidth=60us] @230VAC
输出	直流电压	12VDC
	额定电流	6.25A
	额定功率	75W
	电压精度	±2%
	OVP电压	13-18VDC
	纹波与噪声(最大)	<120mVp-p
	通道	1
保护	短路	关闭输出, 故障排除后自动恢复
	过压	关断输出, 重启后故障自动恢复
	过载	打嗝, 移除故障后自恢
安全与电磁兼容	雷涌	L-N: 2kV,L,N-PG:4kV
	耐受电压	I/P-O/P:3000VAC/5mA I/P-PG:1500VAC/5mA O/P-PG:500VAC/5mA
	安全标准	IEC/EN61347-1, IEC/EN61347-2-13, GB19510.1, GB19510.14
	电磁干扰	EN50515, EN61000-3-2 Class C, IEC61000-3-3, GB/T17743
	电磁抗扰度	EN61000-4-2,3,4,5,6,8,11 EN61547,GB17625.1
功能	调光模式	DALI/Touch DIM(Push DIM)
	调光范围	0.1%-100%
	DALI标准	IEC62386-101, IEC62386-102, IEC62386-207
其它	工作温度	-25°C~+50°C
	储存温度&湿度	-40°C~85°C, 20-90%RH
	Tc	90°C
	材质	金属
	防水等级	IP67
	寿命	50,000h@tc:85°C
	质保	5年
	开关次数	>25,000次
	箱重尺寸	净重: 820g±5%/个; 20个/箱; 17kg±5%/箱; 外箱尺寸: 325*315*195mm [长*宽*高]
产品尺寸	270*61*25毫米[长*宽*高]	

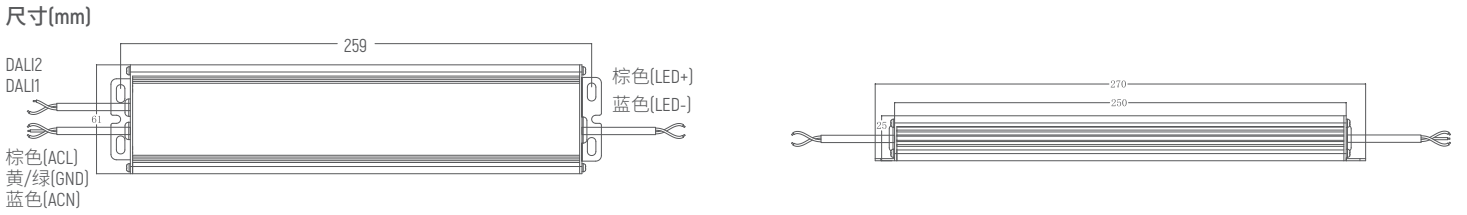

应用接线图

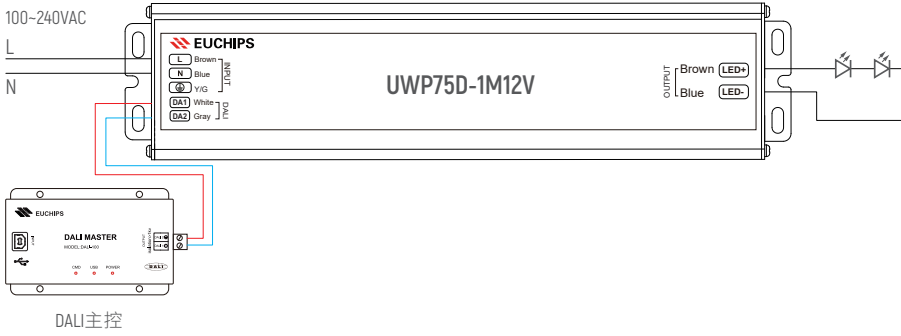

调光曲线

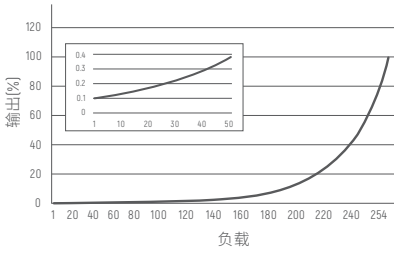

降额曲线

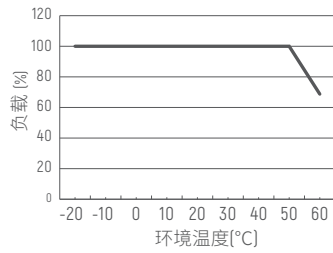

PF vs 负载

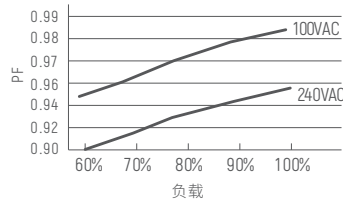

效率 vs 负载

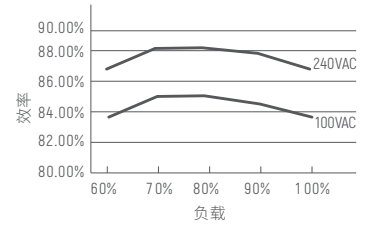

DALI应用图

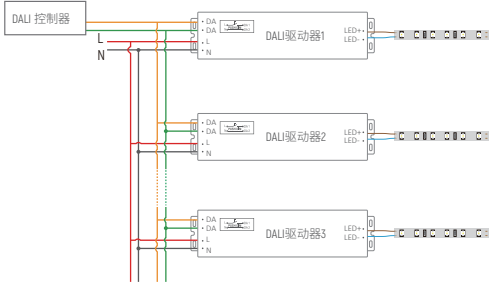

Touch DIM(Push DIM)应用图

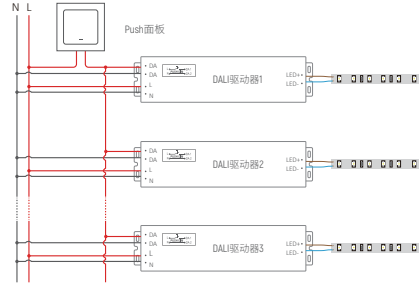

备注: 只能使用开路的按压式开关(不带指示灯)。采用同步连线时每个设备和设备之间的线长不超过20米

Touch Dim(Push DIM)功能

1. 长按8s进入Touch DIM模式。
2. 短按Touch DIM 开关 (<0.5秒) 进行灯的亮暗控制。
3. 长按Touch DIM 开关 (>0.5秒) 进行灯具的亮度调节, 光是调亮还是调暗, 随着每次按压的开关变化而变换。
4. 双击Touch DIM 开关 (<0.3秒), 连接的所有灯具将达到最亮状态。
5. 亮度调节范围为1%-100%。
6. 具有断电记忆功能, 重新上电将恢复到上一次断电的状态。

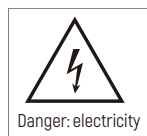

说明书应配有控制装置, 控制装置具有FELV控制端子, 说明如下:  
 警告: 标有“触电危险”的FELV端子不可安全触摸。  
 警告: 连接到任何FELV控制终端的电路应在以下低压供电电压下绝缘控制装置和任何连接到FELV电路的终端应受到保护意外接触。

本灯具的外部软电缆或软线不可更换; 若软线损坏, 应将灯具的调光电路(FELV电路)与输入端绝缘, 由基本绝缘调光电路(FELV电路)与输出端绝缘, 由辅助绝缘调光电路(FELV电路)与输出端绝缘通过功能绝缘与接地导电部件绝缘。

※ 本说明书内容如有更新, 恕不另行通知。若您使用的产品功能与说明书不一致时, 请以产品为准。如有疑问请与我们联系。