

LED VALUE PANEL TRI COLOR Backlit G2

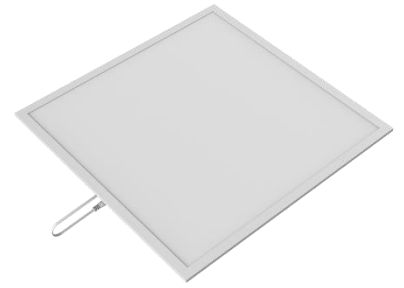

Highlights:

- Latest backlit LED technology platform
- 3CCT Switchable
- Efficacy up to 120lm/W
- Available in 3 standard sizes:
- IP40 protection from diffuser side
- Long 50,000hr lifetime

Application Areas:

- Offices
- Retail shops
- Hospitals
- Public area

Advancing Light

One of the World's leaders in general lighting for lighting professionals as well as end users, offering



A broad variety of LED luminaires



Advanced LED lamps



Intelligent, networked Smart Home & Smart Building solutions



Traditional light sources



LED VALUE PANEL TRI COLOR Backlit G2

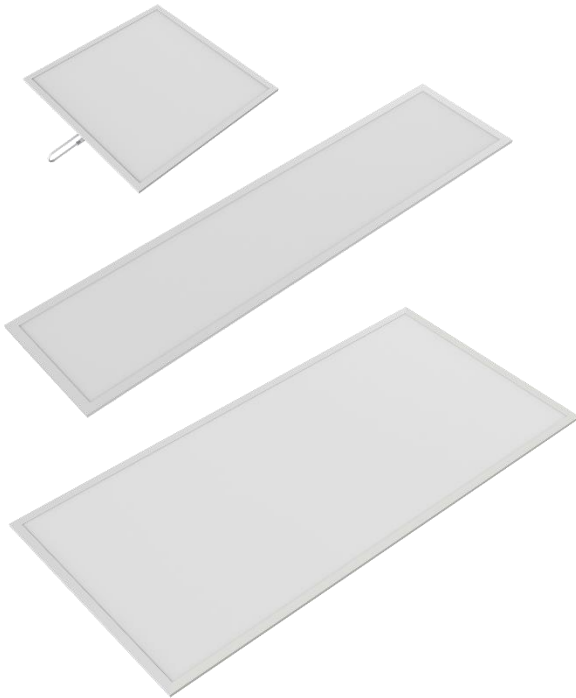

PRODUCT FEATURES:

- Latest backlit LED technology platform
- Available in 3 standard metric sizes: 600x600, 300x1200, 600x1200mm
- Switchable CCT: 3000K, 4200K & 6500K
- High color rendering: CRI > 80
- High power factor: PF>0.90
- Recess mount with optional plaster ceiling mounting clips and suspension kit
- Flicker free driver
- EMC suppression circuit in driver
- Sturdy SPCC housing
- Slimmer housing design in 27mm and 32mm height
- Safety compliance certificates: CB
- EU RoHS 2.0 compliant

PRODUCT BENEFITS:

- Integrated heat resistance lens for uniform light distribution, reduce product height to only 27mm & 32mm
- Long 50,000hr lifetime reduces maintenance costs
- Fast connector between panel and driver for easy installation and maintenance
- Seamless aluminum frame elegant design
- Switchable CCT 3000K, 4200K and 6500K helps reduce inventory





Product Information

LED VALUE PANEL TRI COLOR BACKLIT G2		0606	0312	0612
Electrical Data	Wattage (W)	33W		49W
	Voltage range	220 - 240VAC		
	Power factor	> 0.9		
	Input current	155mA		230 mA
	Output current	810 mA		1200 mA
	Line frequency	50/60Hz		
	Surge Protection	> 1000V		
	THD	≤ 15 %		
	Protection class	Class II		
Optical / Photometric	Rated lumens	4000lm (4200K/6500K) 3680lm (3000K)		5850lm (4200K/6500K) 5380lm (3000K)
	Switchable CCT(K)	3000K, 4200K, 6500K		
	Beam angle	110°		
	CRI	80		
	SDCM	< 5 (3000K & 6500K), <6 (4200K)		
	System lumen efficacy	120lm/W		
	UGR	≤ 22		
	LED	SMD 2835		
	Rated lifetime	50,000 hrs @ L70 (Ta=25°C)		
	Operating temperature	-10 ~ +50°C		
	Storage temperature	-20 ~ +70°C		
Housing	Frame	Aluminum welded seamless		
	Housing	SPCC with white spray painting		
	Diffuser	UV resistant modified PS		
	Panel size (L x W x H mm)	595x595x27	1195x295x32	1195x595x32
	Weight (g)	1450	1530	3100
	Ingress protection	IP40(front)/IP20		
	Mounting	Recessed mount optional plaster ceiling mounting clips and suspension kits		



Polar Intensity Diagram

Panel 0606

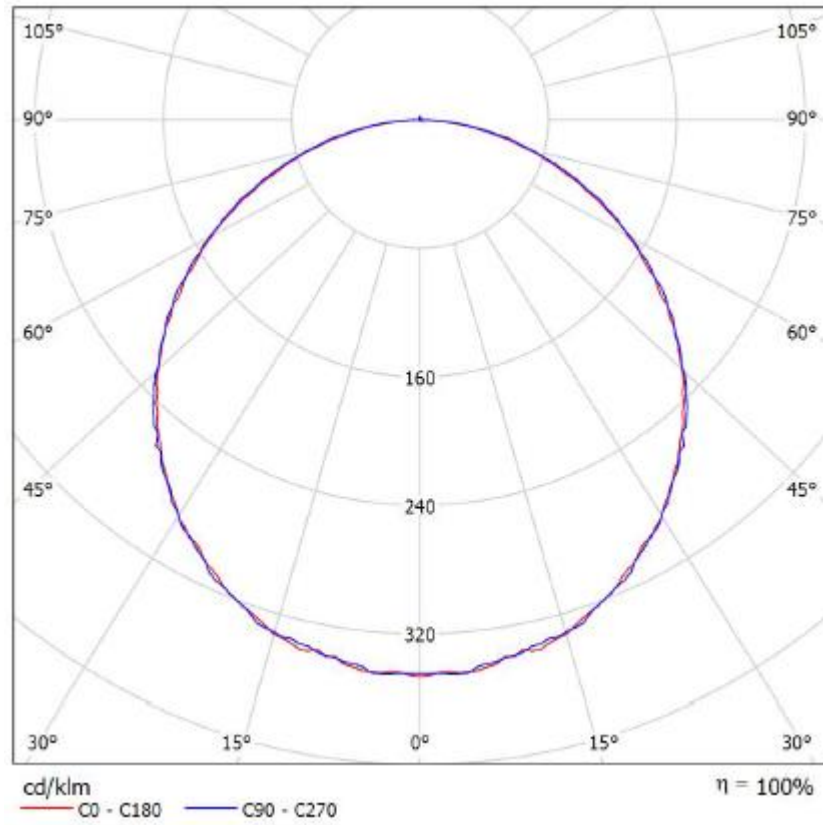

Panel 0312

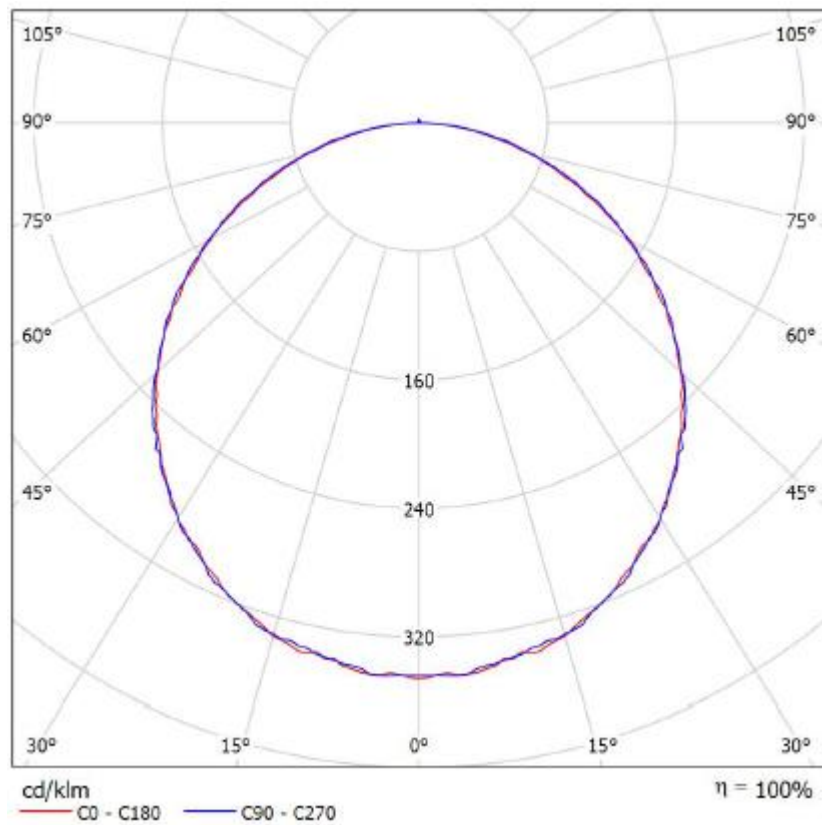



Polar Intensity Diagram

Panel 0612

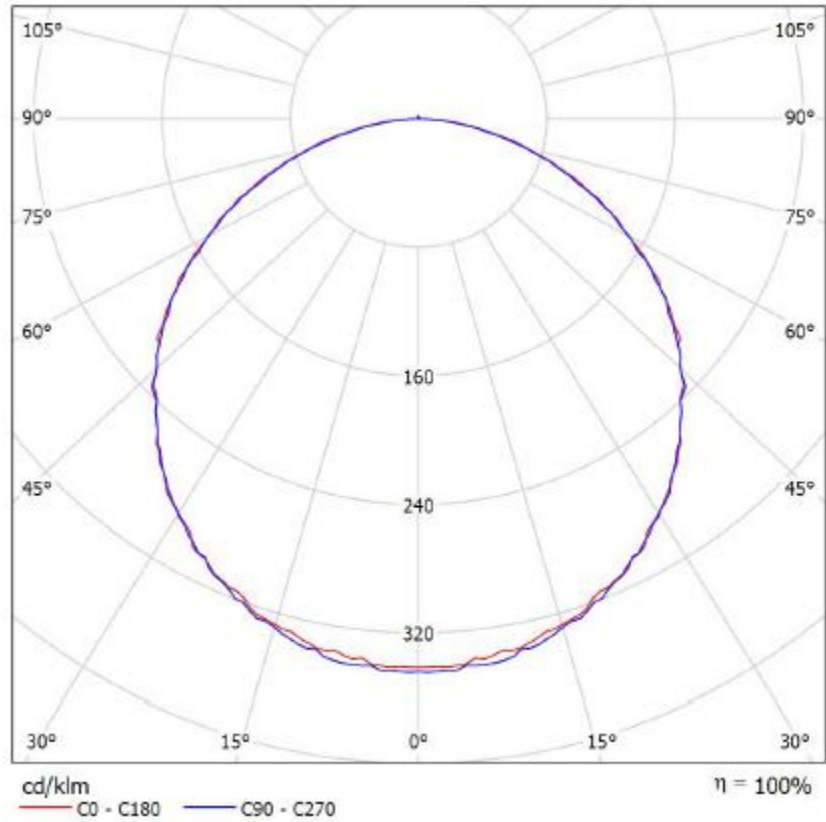



Drawing/Dimensions

Panel 0606

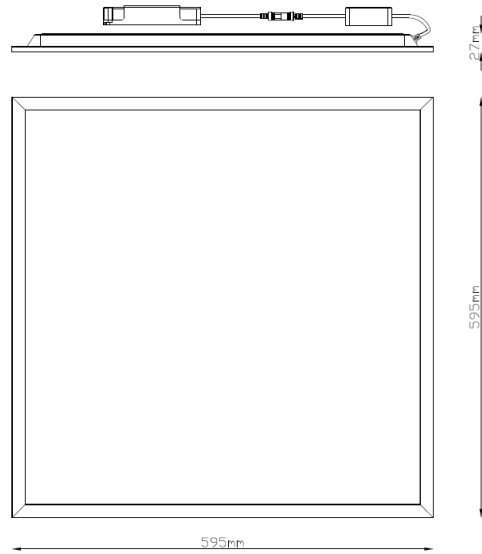

Panel	Length	Width	Height	Weight
0606	595mm	595mm	27mm	1450g

Panel 0312

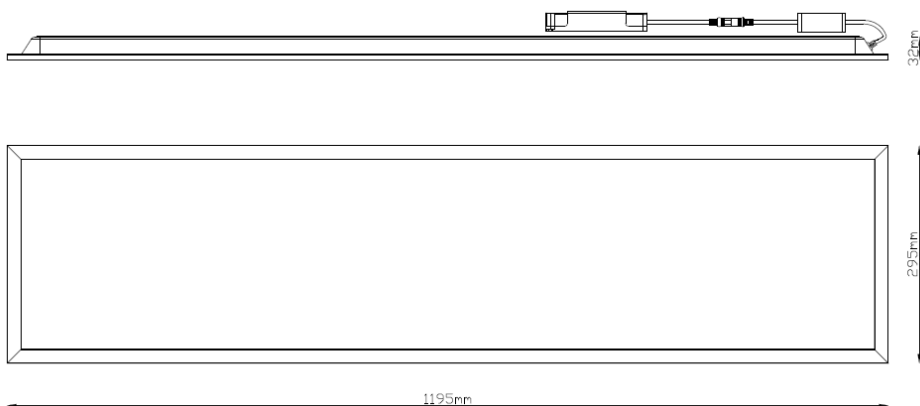

Panel	Length	Width	Height	Weight
0312	1195mm	295mm	32mm	1530g



Drawing/Dimensions

Panel 0612

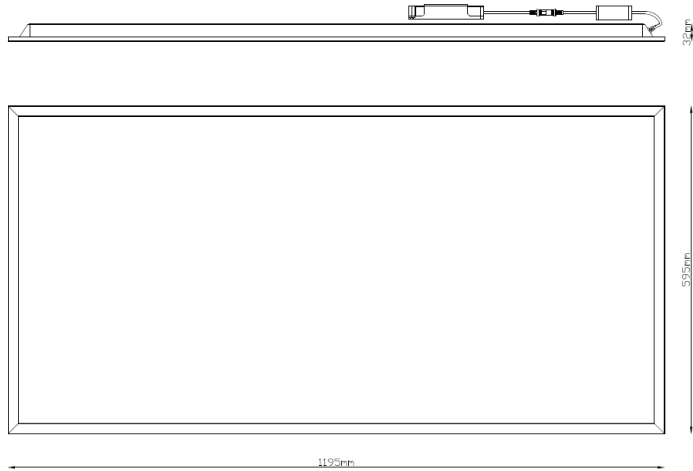

Panel	Length	Width	Height	Weight
0612	1195mm	595mm	32mm	3100g

Ordering Information

LED VALUE PANEL TRI COLOR

Description	Model Number	Shipping Unit	EAN10	EAN40
LDVAL PL0606B 33W TRI8 6X1 G2 YK SGLEDV	V-PL0606B-33WTR8-Y	6	4099854103926	4099854103933
LDVAL PL0312B 33W TRI8 6X1 G2 YK SGLEDV	V-PL0312B-33WTR8-Y	6	4099854103940	4099854103957
LDVAL PL0612B 49W TRI8 4X1 G2 YK SGLEDV	V-PL0612B-49WTR8-Y	4	4099854103964	4099854103971



Optional accessories

Plaster ceiling mounting clips

Description	Shipping Unit	EAN10	EAN40
PL RECESSED MOUNT CLIPS VAL 4X4 APMLEDV	4	4099854020957	4099854020964

Each EAN10 bag contains 4 mounting clips and 8 screws.
 Each EAN40 box contains 4 EAN10 bags.
 Each EAN50 box contains 6 EAN40 boxes.



Optional suspension kit

Description	Shipping Unit	EAN10	EAN40
PL SUSPENSION KIT LEDV	1	4058075402928	4058075402935

Each EAN10 bag contains 2 lines, 4 brackets, and 8 screws.
 Each EAN40 box contains 4 EAN10 bags.



Optional accessories

Recessed mount frame

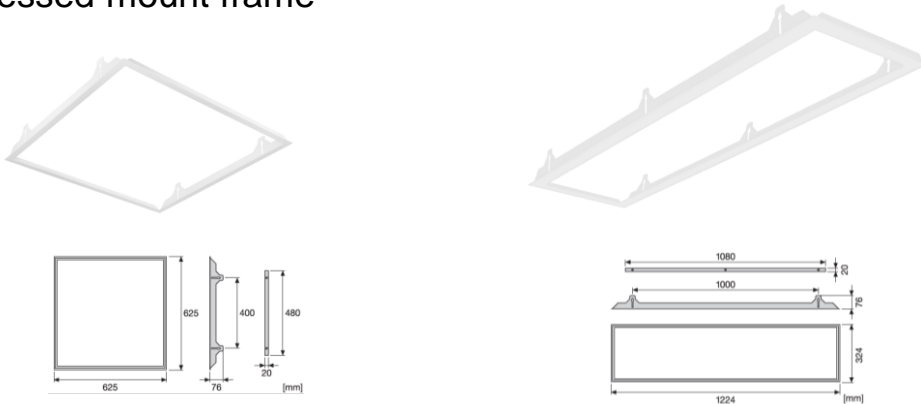

Suitable for ceiling thickness from 8mm to 30mm
Material: extruded aluminum frame

Description	Packaging	EAN10	EAN40
PL 600 RECESSED MOUNT FRAME LEDV	2x1	4058075402881	4058075402898
PL 1200X300 RECESSEDMOUNTFRAME LEDV	4x1	4058075472976	4058075472983

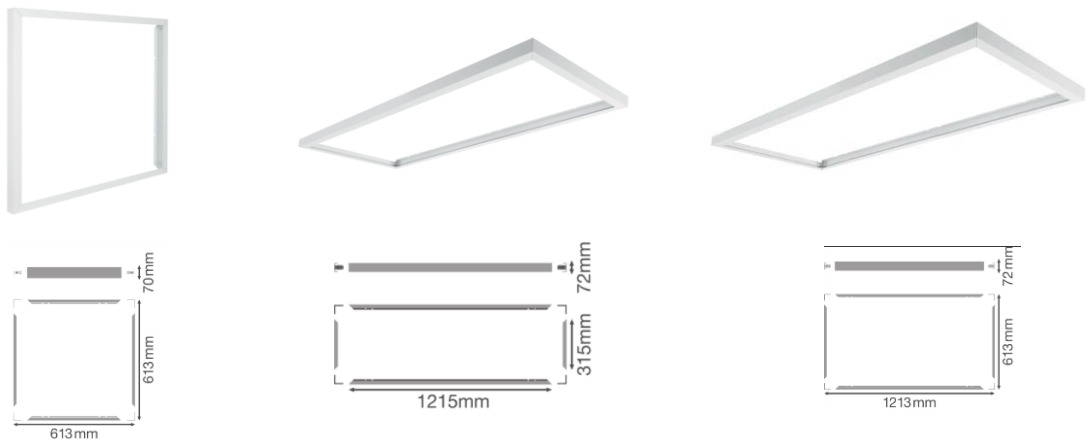

Material: extruded aluminum frame with polycarbonate corner clips
Panel insertion from short or long frame sides possible (for rectangular version only)

Description	Packaging	EAN10	EAN40
PL 600 SURFACE MOUNT KIT H70 VAL LEDV	4x1	4058075402843	4058075402850
PL 1200X300 SF MOUNT KIT H70 VAL LEDV	4x1	4099854018497	4058075821699
PL 1200X600 SURFACE MOUNT KIT VAL LEDV	3x1	4058075389823	4058075407541



Optional accessories

ECO surface mounting kit

Description	Shipping Unit	EAN10	EAN40	For panel size
ECOPANEL600SURFACMOUNTKITH7010X1EUELEDV	10	4058075699502	4058075699519	595X595mm

Each EAN10 box contains 1 kit

Each EAN40 box contains 4 EAN10 boxes

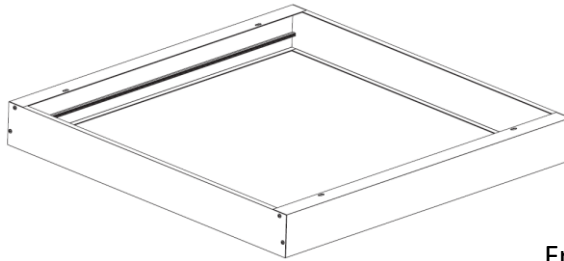

Frames jointed with screws