

EX-PROOF LED FLOODLIGHT

SXF80 Series



- ✓ **COMPACT**
- ✓ **ROBUST**
- ✓ **LIGHTWEIGHT**
- ✓ **VIBRATION-PROOF**



TECHNICAL INFORMATION

Certification	ATEX and IECEx approvals certified by BV and ClassNK for Zones 1/2 & 21/22 applications Ex db eb op is IIC T6/T5/T4 Gb and Ex tb op is IIIC T80°C/T100°C/T135°C Db IP66 and IP67 Ingress Protection IK08 Impact Protection
Housing	Marine grade seawater resistant aluminium alloy body with anti-corrosion powder coating SUS316 stainless steel mounting bracket, protection guard and external fasteners RAL5002 Ultramarine blue colour
Electric	Integrated ACIC light engine supports dual voltage AC100V-120V/220V-240V ELV dimming support Power factor >0.99
Lifespan	Ultra-long LED service life of 100,000 hours @ 40°C
Connection	1x M20 Ex de cable gland for non-armoured cable of diameter 11mm to 15mm Option for additional and/or different size cable glands Ex e external GRP junction box with terminals up to 4mm ²
Beam Angle	Available in both narrow and wide beams
EMC	IEC 60533 electromagnetic compatibility to all maritime vessels and offshore MDUs

CERTIFICATIONS

SXF8011

ATEX Directive (2014/34/EU)
EPS 18 ATEX 1 191 X
IECEX EPS 18.0097X

Ex II 2 GD
Ex db eb op is IICT6/T5 Gb
Ex tb op is IIICT80°C/T100°C Db
 $-40^{\circ}\text{C} \leq T_{\text{amb}} \leq +40^{\circ}\text{C}/+50^{\circ}\text{C}$

SXF8012 / SXF8013

Ex II 2 GD
Ex db eb op is IICT6/T5/T4 Gb
Ex tb op is IIICT80°C/T100°C/T135°C Db
 $-40^{\circ}\text{C} \leq T_{\text{amb}} \leq +30^{\circ}\text{C}/+40^{\circ}\text{C}/+50^{\circ}\text{C}$

MEASUREMENTS

SXF8011

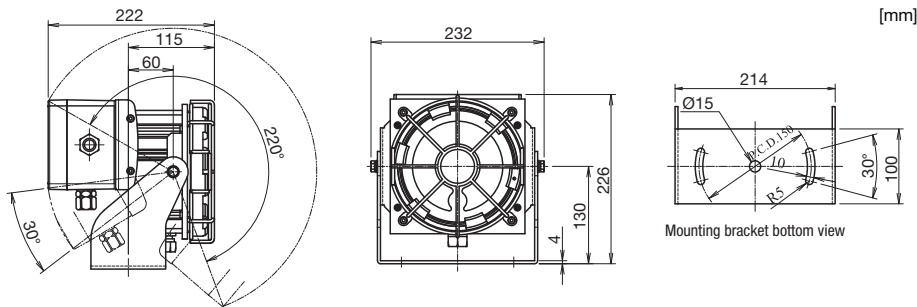

SXF8012

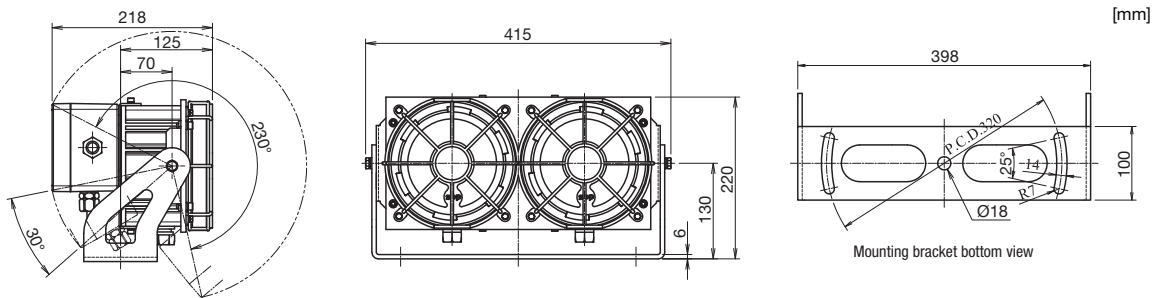

SXF8013

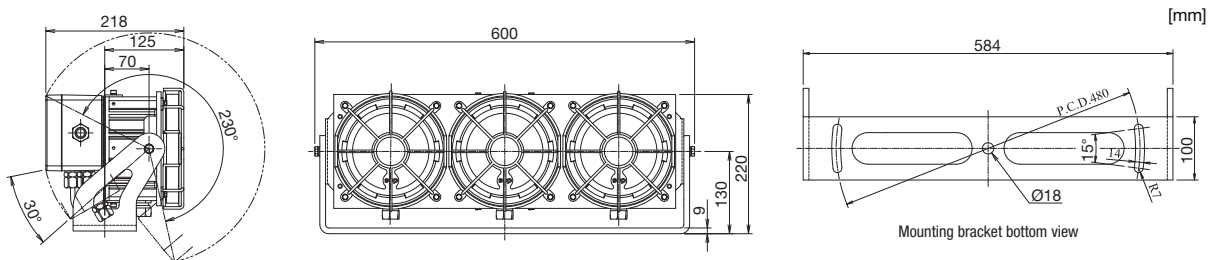

Ideal Replacement:

SXF8011 for: 150W (MH), 250W (Mercury), 500W (Halogen)
SXF8012 for: 250W (MH), 400W (Mercury), 1000W (Halogen)
SXF8013 for: 250W (HPS), 400W (MH), 1500W (Halogen)

ORDER CODES

Item Code	Type	Main Voltage	Power	CCT	Beam Angle	System Lumen	Peak Candlepower	Weight
CIGLASXF8011W	SXF8011W	100V - 120V AC / 220V - 240V AC	78W	5000K	108°	6000lm	2000cd	5.8Kg
CIGLASXF8011N	SXF8011N	100V - 120V AC / 220V - 240V AC	78W	5000K	36°	5680lm	7500cd	6.0Kg
CIGLASXF8012W	SXF8012W	100V - 120V AC / 220V - 240V AC	156W	5000K	108°	12000lm	4000cd	11.5Kg
CIGLASXF8012N	SXF8012N	100V - 120V AC / 220V - 240V AC	156W	5000K	36°	11800lm	16000cd	11.7Kg
CIGLASXF8013W	SXF8013W	100V - 120V AC / 220V - 240V AC	234W	5000K	108°	17100lm	6400cd	17.0Kg
CIGLASXF8013N	SXF8013N	100V - 120V AC / 220V - 240V AC	234W	5000K	36°	16900lm	22000cd	17.3Kg

** Optional DC24V

PHOTOMETRIC DATA

SXF8011F

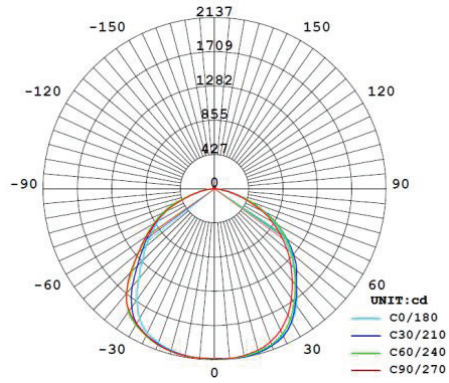

SXF8011N

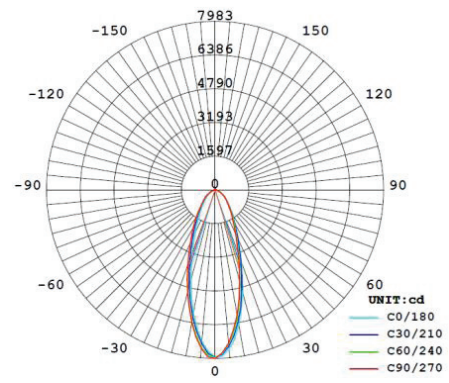

SXF8012F

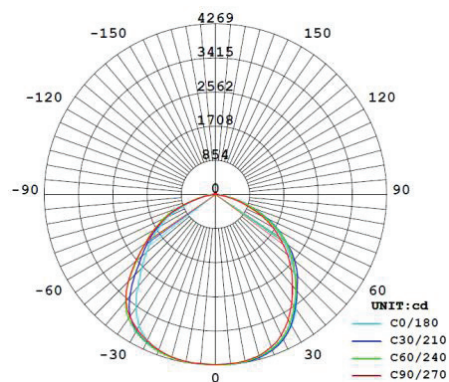

SXF8012N

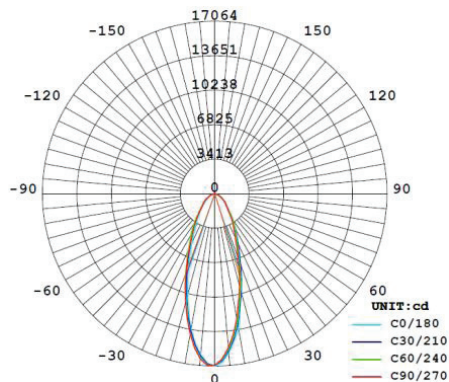

SXF8013F

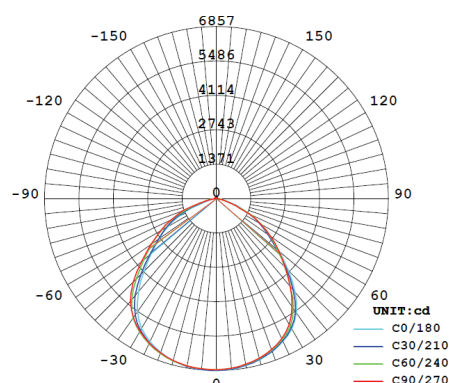

SXF8013N

