



PHILIPS

LEDspot LV



Technical Application Guide

Philips Master LEDspot LV MR16 6.5W

Philips Master LED MR16 is the latest in Philips' series of low voltage (12VAC) Halogen MR16 replacements. Not only does it employ Philips' patented solution to guarantee the broadest possible compatibility with standard 12V Halogen electronic transformers, it also delivers beam intensity which equivalent to 50W Philips Halogen MR16 lamp.

Its high SDCM ensure more strict color consistency, and also new smaller housing provide perfect fitting with majority of lumianires in market.



www.philips.com



Design highlights

- The innovative trimless lens design with single optic lens
- Up to 88% energy saving compared to standard halogen MR16 lamps
- Long lifetime of 40,000 hours (F50, L70)
- Retrofits into a vast majority of GU5.3 based fixtures
- Compatible with a broad selection of transformers
- Strong color consistency per batch (4SDCM) and stay over the time
- 10, 24 & 36 degrees beam angle for a clearly defined beam spread
- CCT: 2700K, 3000K, 4000K
- No UV and Cool Beam (no IR), making it suitable for illuminating heat-sensitive objects like food, organic materials, paintings, etc.
- Environmental friendly; free of mercury and other hazardous materials
- RoHS compliant



Application areas

Suitably designed for general lighting applications in the hospitality and retail segment. Its trimless lens design with single optic look suit any interior decor with ins clean and neat look.

Unlike the conventional halogen reflector lamp, it has only 6.5W consumption per lamp with long lifetime of 40,000 hours (or equivalent to 27 years if lit continuously for 4hrs a day) ensuring minimum maintenance cost in hospitality and retail segment. It is suitable for various applications such as:

- Lobby / Reception areas
- Hotel room / Ball room / Business center
- Restaurants / Bar / Cafe
- Corridors / Stairway / Washroom
- Display area / Dress room / Check out

Application notes

- Suitable for totally enclosure fixture application (refer to failure rate curve, make sure Tc is not over max)
- Operating temperature range is between -20°C and 40°C ambient
- For use in fixtures that can structurally support a lamp weighing 60 grams
- Compatible with broad transformers (refer to the recommended with a broad selection of transformers list), also suitable for 12V DC input
- Do not use or install the lamp in wet environment
- Not intended for use with emergency light fixtures or exit lights

Product features

Technical Specifications

Product type	Cap	Bulb Shape	Lamp Wattage (W)	Replaced Wattage (W)	CCT (K)	Beam Angle (°)	Lumen (lm)	MBCP (Cd)	Lifetime (Hrs)	CRI	Switch Cycle (times)
MASTER LED 6.5-50W 927 MR16 10D Dim CN	GU5.3	MR16	6.5	50	2700	10	500	5300	40000	90	50000
MASTER LED 6.5-50W 930 MR16 10D Dim CN	GU5.3	MR16	6.5	50	3000	10	500	5300	40000	90	50000
MASTER LED 6.5-50W 940 MR16 10D Dim CN	GU5.3	MR16	6.5	50	4000	10	530	5600	40000	90	50000
MASTER LED 6.5-50W 927 MR16 24D Dim CN	GU5.3	MR16	6.5	50	2700	24	500	2800	40000	90	50000
MASTER LED 6.5-50W 927 MR16 24D Dim CN	GU5.3	MR16	6.5	50	2700	24	500	2800	40000	90	50000
MASTER LED 6.5-50W 930 MR16 24D Dim CN	GU5.3	MR16	6.5	50	3000	24	500	2800	40000	90	50000
MASTER LED 6.5-50W 930 MR16 24D Dim CN	GU5.3	MR16	6.5	50	3000	24	500	2800	40000	90	50000
MASTER LED 6.5-50W 940 MR16 24D Dim CN	GU5.3	MR16	6.5	50	4000	24	530	3400	40000	90	50000
MASTER LED 6.5-50W 927 MR16 36D Dim CN	GU5.3	MR16	6.5	50	2700	36	500	1400	40000	90	50000
MASTER LED 6.5-50W 927 MR16 36D Dim CN	GU5.3	MR16	6.5	50	2700	36	500	1400	40000	90	50000
MASTER LED 6.5-50W 930 MR16 36D Dim CN	GU5.3	MR16	6.5	50	3000	36	500	1600	40000	90	50000
MASTER LED 6.5-50W 930 MR16 36D Dim CN	GU5.3	MR16	6.5	50	3000	36	500	1600	40000	90	50000
MASTER LED 6.5-50W 940 MR16 36D Dim CN	GU5.3	MR16	6.5	50	4000	36	530	1600	40000	90	50000
MASTER LED 6.5-50W 927 MR16 10D Dim	GU5.3	MR16	6.5	50	2700	10	500	5300	40000	90	50000
MASTER LED 6.5-50W 930 MR16 10D Dim	GU5.3	MR16	6.5	50	3000	10	500	5300	40000	90	50000
MASTER LED 6.5-50W 940 MR16 10D Dim	GU5.3	MR16	6.5	50	4000	10	530	5600	40000	90	50000
MASTER LED 6.5-50W 927 MR16 24D Dim	GU5.3	MR16	6.5	50	2700	24	500	2800	40000	90	50000
MASTER LED 6.5-50W 927 MR16 24D Dim	GU5.3	MR16	6.5	50	2700	24	500	2800	40000	90	50000
MASTER LED 6.5-50W 930 MR16 24D Dim	GU5.3	MR16	6.5	50	3000	24	500	2800	40000	90	50000
MASTER LED 6.5-50W 930 MR16 24D Dim	GU5.3	MR16	6.5	50	3000	24	500	2800	40000	90	50000
MASTER LED 6.5-50W 940 MR16 24D Dim	GU5.3	MR16	6.5	50	4000	24	530	3400	40000	90	50000
MASTER LED 6.5-50W 940 MR16 24D Dim	GU5.3	MR16	6.5	50	4000	24	530	3400	40000	90	50000
MASTER LED 6.5-50W 927 MR16 36D Dim	GU5.3	MR16	6.5	50	2700	36	500	1400	40000	90	50000
MASTER LED 6.5-50W 927 MR16 36D Dim	GU5.3	MR16	6.5	50	2700	36	500	1400	40000	90	50000
MASTER LED 6.5-50W 930 MR16 36D Dim	GU5.3	MR16	6.5	50	3000	36	500	1600	40000	90	50000
MASTER LED 6.5-50W 930 MR16 36D Dim	GU5.3	MR16	6.5	50	3000	36	500	1600	40000	90	50000
MASTER LED 6.5-50W 940 MR16 36D Dim	GU5.3	MR16	6.5	50	4000	36	530	1600	40000	90	50000
MASTER LED 6.5-50W 940 MR16 36D Dim	GU5.3	MR16	6.5	50	4000	36	530	1600	40000	90	50000
MASTER LED 6.5-50W 927 MR16 60D Dim	GU5.3	MR16	6.5	50	2700	60	500	500	40000	90	50000
MASTER LED 6.5-50W 930 MR16 60D Dim	GU5.3	MR16	6.5	50	3000	60	500	500	40000	90	50000
MASTER LED 6.5-50W 940 MR16 60D Dim	GU5.3	MR16	6.5	50	4000	60	530	550	40000	90	50000

Technical Specifications

Product type	Voltage (V AC)	DIM	Input Current (mA)	12nc	EAN1
MASTER LED 6.5-50W 927 MR16 10D Dim CN	12V AC electronic	Yes	650	929003071610	6922341937187
MASTER LED 6.5-50W 930 MR16 10D Dim CN	12V AC electronic	Yes	650	929003071710	6922341937200
MASTER LED 6.5-50W 940 MR16 10D Dim CN	12V AC electronic	Yes	650	929003071810	6922341937224
MASTER LED 6.5-50W 927 MR16 24D Dim CN	12V AC electronic	Yes	650	929003071910	6922341937248
MASTER LED 6.5-50W 927 MR16 24D Dim CN	12V AC electronic	Yes	650	929003071920	6922341937446
MASTER LED 6.5-50W 930 MR16 24D Dim CN	12V AC electronic	Yes	650	929003072010	6922341937262
MASTER LED 6.5-50W 930 MR16 24D Dim CN	12V AC electronic	Yes	650	929003072020	6922341937460
MASTER LED 6.5-50W 940 MR16 24D Dim CN	12V AC electronic	Yes	650	929003072110	6922341937286
MASTER LED 6.5-50W 927 MR16 36D Dim CN	12V AC electronic	Yes	650	929003072210	6922341937309
MASTER LED 6.5-50W 927 MR16 36D Dim CN	12V AC electronic	Yes	650	929003072220	6922341937484
MASTER LED 6.5-50W 930 MR16 36D Dim CN	12V AC electronic	Yes	650	929003072310	6922341937323
MASTER LED 6.5-50W 930 MR16 36D Dim CN	12V AC electronic	Yes	650	929003072320	6922341937507
MASTER LED 6.5-50W 940 MR16 36D Dim CN	12V AC electronic	Yes	650	929003072410	6922341937347
MASTER LED 6.5-50W 927 MR16 10D Dim	12V AC electronic	Yes	650	929003071608	8719514357693
MASTER LED 6.5-50W 930 MR16 10D Dim	12V AC electronic	Yes	650	929003071708	8719514357716
MASTER LED 6.5-50W 940 MR16 10D Dim	12V AC electronic	Yes	650	929003071808	8719514357730
MASTER LED 6.5-50W 927 MR16 24D Dim	12V AC electronic	Yes	650	929003071908	8719514357754
MASTER LED 6.5-50W 927 MR16 24D Dim	12V AC electronic	Yes	650	929003071918	8719514357778
MASTER LED 6.5-50W 930 MR16 24D Dim	12V AC electronic	Yes	650	929003072008	8719514357792
MASTER LED 6.5-50W 930 MR16 24D Dim	12V AC electronic	Yes	650	929003072018	8719514357815
MASTER LED 6.5-50W 940 MR16 24D Dim	12V AC electronic	Yes	650	929003072108	8719514357839
MASTER LED 6.5-50W 940 MR16 24D Dim	12V AC electronic	Yes	650	929003072118	8719514357853
MASTER LED 6.5-50W 927 MR16 36D Dim	12V AC electronic	Yes	650	929003072208	8719514357877
MASTER LED 6.5-50W 927 MR16 36D Dim	12V AC electronic	Yes	650	929003072218	8719514357891
MASTER LED 6.5-50W 930 MR16 36D Dim	12V AC electronic	Yes	650	929003072308	8719514357914
MASTER LED 6.5-50W 930 MR16 36D Dim	12V AC electronic	Yes	650	929003072318	8719514357938
MASTER LED 6.5-50W 940 MR16 36D Dim	12V AC electronic	Yes	650	929003072408	8719514357952
MASTER LED 6.5-50W 940 MR16 36D Dim	12V AC electronic	Yes	650	929003072418	8719514357976
MASTER LED 6.5-50W 927 MR16 60D Dim	12V AC electronic	Yes	650	929003075908	8719514357990
MASTER LED 6.5-50W 930 MR16 60D Dim	12V AC electronic	Yes	650	929003076008	8719514358010
MASTER LED 6.5-50W 940 MR16 60D Dim	12V AC electronic	Yes	650	929003076108	8719514358034

Fixture Compatibility

Type	C max. Overall Length (mm)	D max. Diameter (mm)	Weight unpacked (gram)
Master LED 6.5W	46.5	50.5	60

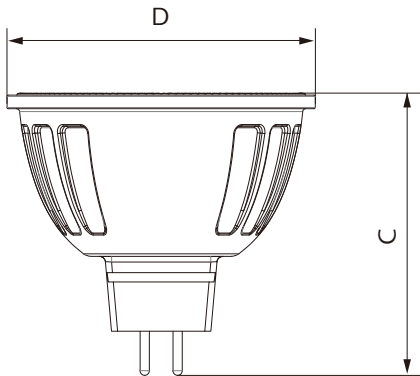

Spectral Power Distribution

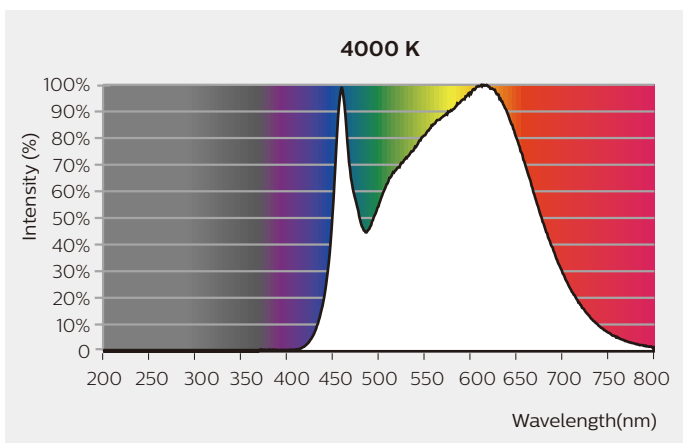
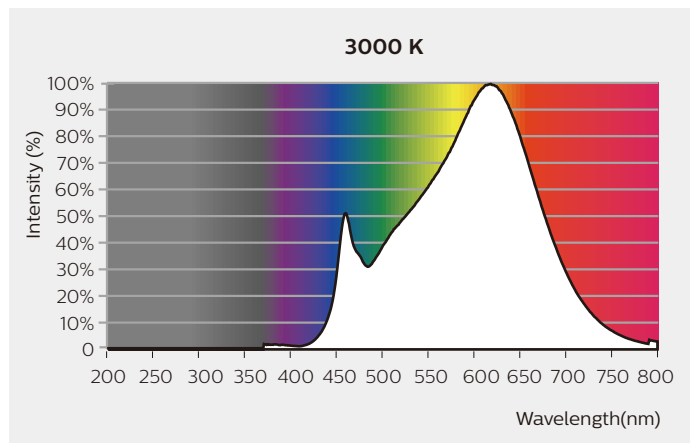
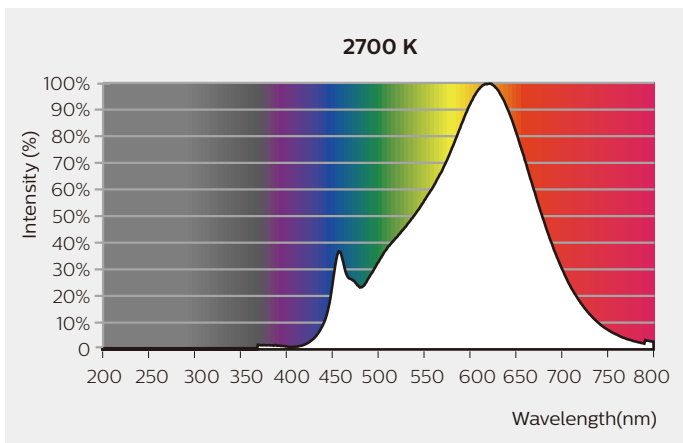

Temperature

Philips LED MR16 is designed for operation in all GU5.3 lighting installations in open and closed fixtures, refer to the failure rate curve, make sure Tc is not over the max temperature.

LEDspotLV MR16 6.5W

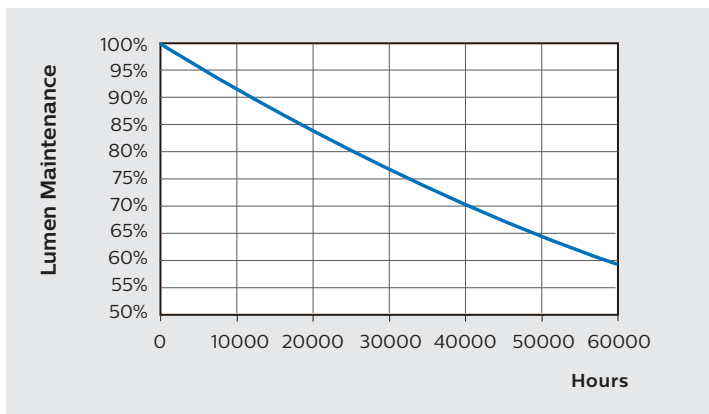
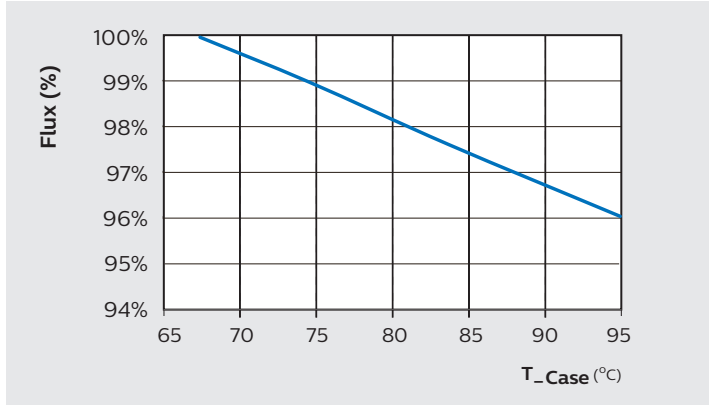

Photometric Diagrams

MASTER LED 6.5-50W 927 MR16 10D Dim CN

1 x 500 lm

Light output ratio	1.00	lmax	4574 cd
Service upward	0.00	BS (1/2 l _{max})	2 x 7°
Service downward	1.00	BS (1/2 E ₀)	2 x 7°

Polar intensity diagram

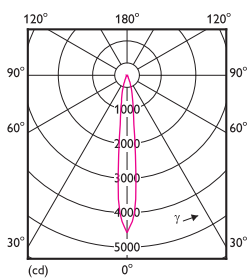

Cartesian intensity diagram

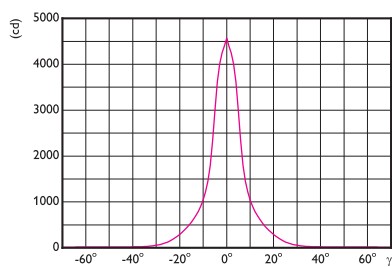

Beam diagram

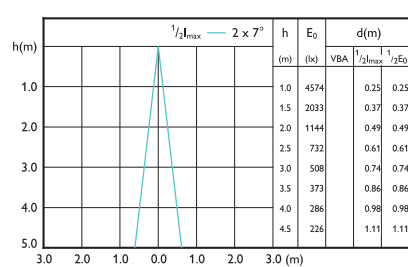

Visual impact diagram

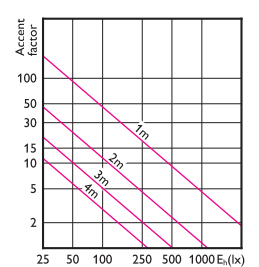

MASTER LED 6.5-50W 930 MR16 10D Dim CN

1 x 500 lm

Light output ratio	1.00	I_{max}	4574 cd
Service upward	0.00	$BS (\frac{1}{2} I_{max})$	$2 \times 7^\circ$
Service downward	1.00	$BS (\frac{1}{2} E_0)$	$2 \times 7^\circ$

Polar intensity diagram

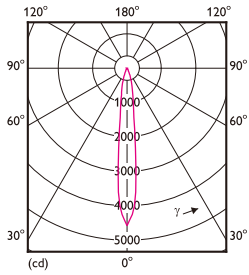

Cartesian intensity diagram

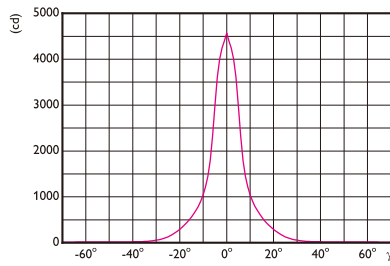

Beam diagram

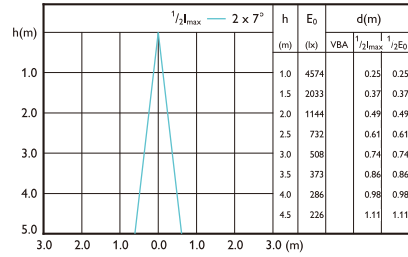

Visual impact diagram

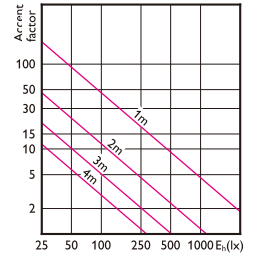

MASTER LED 6.5-50W 940 MR16 10D Dim CN

1 x 530 lm

Light output ratio	1.00	I_{max}	4849 cd
Service upward	0.00	$BS (\frac{1}{2} I_{max})$	$2 \times 7^\circ$
Service downward	1.00	$BS (\frac{1}{2} E_0)$	$2 \times 7^\circ$

Polar intensity diagram

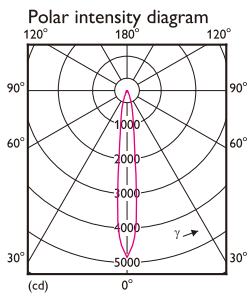

Cartesian intensity diagram

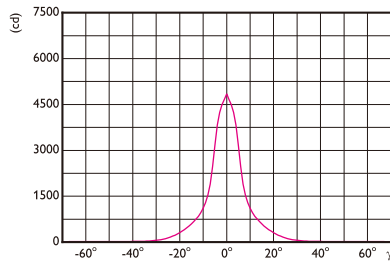

Beam diagram

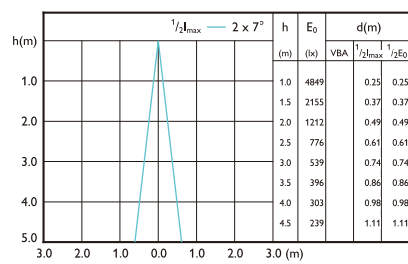

Visual impact diagram

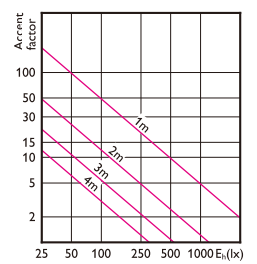

MASTER LED 6.5-50W 927 MR16 24D Dim CN

1 x 500 lm

Light output ratio	1.00	I_{max}	2471 cd
Service upward	0.00	$BS (\frac{1}{2} I_{max})$	$2 \times 11^\circ$
Service downward	1.00	$BS (\frac{1}{2} E_0)$	$2 \times 11^\circ$

Polar intensity diagram

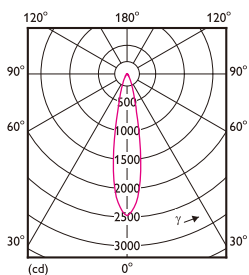

Cartesian intensity diagram

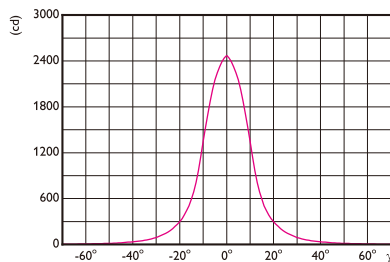

Beam diagram

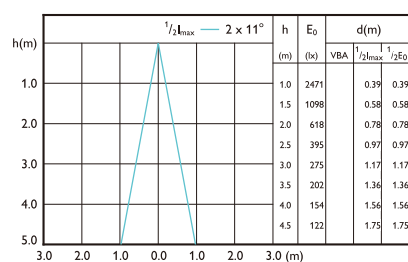

Visual impact diagram

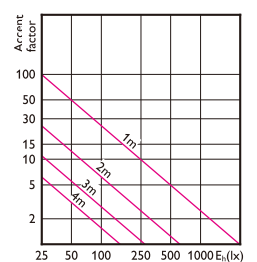

MASTER LED 6.5-50W 930 MR16 24D Dim CN

1 x 500 lm

Light output ratio	1.00	I_{max}	2471 cd
Service upward	0.00	$BS (\frac{1}{2} I_{max})$	$2 \times 11^\circ$
Service downward	1.00	$BS (\frac{1}{2} E_0)$	$2 \times 11^\circ$

Polar intensity diagram

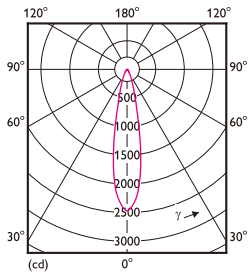

Cartesian intensity diagram

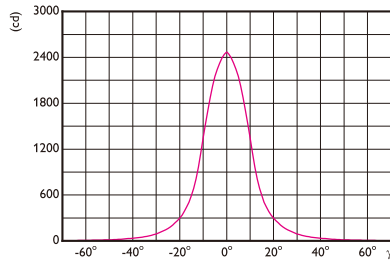

Beam diagram

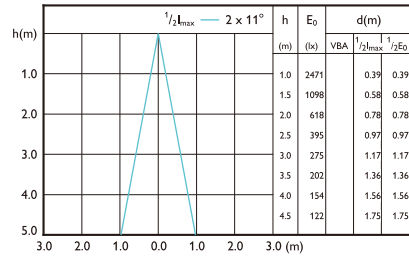

Visual impact diagram

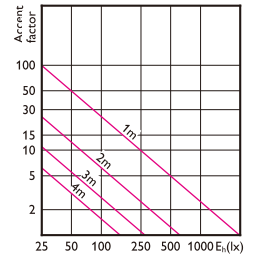

MASTER LED 6.5-50W 940 MR16 24D Dim CN

1 x 530 lm

Light output ratio	1.00	I_{max}	2620 cd
Service upward	0.00	$BS (\frac{1}{2} I_{max})$	$2 \times 11^\circ$
Service downward	1.00	$BS (\frac{1}{2} E_0)$	$2 \times 11^\circ$

Polar intensity diagram

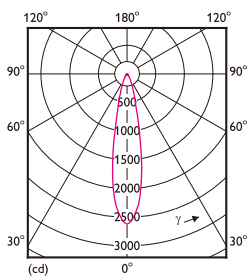

Cartesian intensity diagram

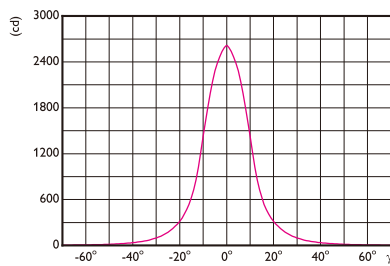

Beam diagram

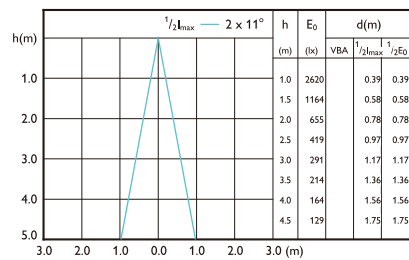

Visual impact diagram

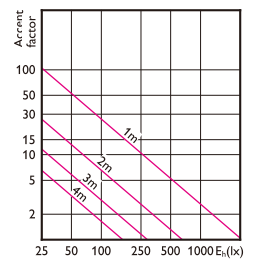

MASTER LED 6.5-50W 927 MR16 36D Dim CN

1 x 500 lm

Light output ratio	1.00	I_{max}	1322 cd
Service upward	0.00	$BS (\frac{1}{2} I_{max})$	$2 \times 18^\circ$
Service downward	1.00	$BS (\frac{1}{2} E_0)$	$2 \times 17^\circ$

Polar intensity diagram

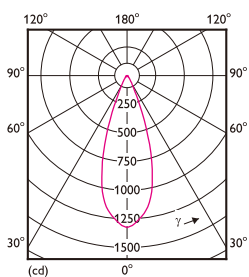

Cartesian intensity diagram

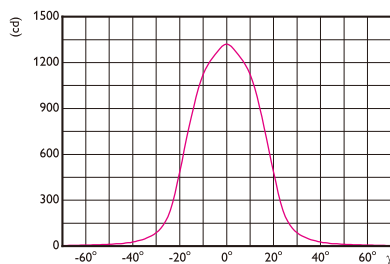

Beam diagram

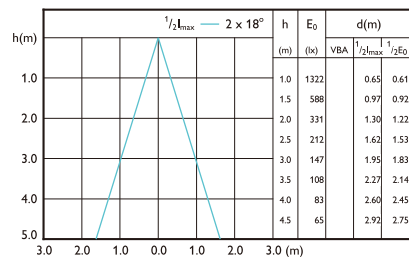

Visual impact diagram

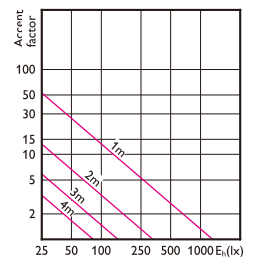

MASTER LED 6.5-50W 930 MR16 36D Dim CN

1 x 500 lm

Light output ratio	1.00	I_{max}	1322 cd
Service upward	0.00	$BS (\frac{1}{2} I_{max})$	$2 \times 18^\circ$
Service downward	1.00	$BS (\frac{1}{2} E_0)$	$2 \times 17^\circ$

Polar intensity diagram

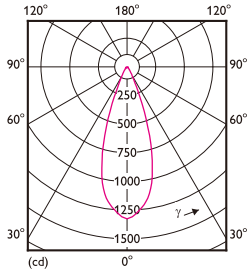

Cartesian intensity diagram

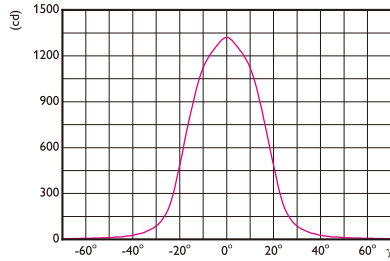

Beam diagram

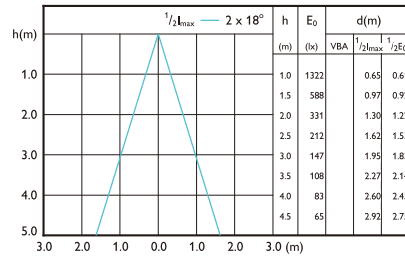

Visual impact diagram

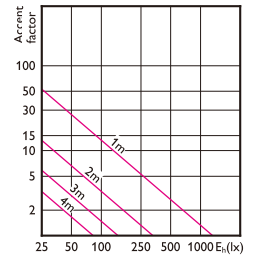

MASTER LED 6.5-50W 940 MR16 36D Dim CN

1 x 530 lm

Light output ratio	1.00	I_{max}	1402 cd
Service upward	0.00	$BS (\frac{1}{2} I_{max})$	$2 \times 18^\circ$
Service downward	1.00	$BS (\frac{1}{2} E_0)$	$2 \times 17^\circ$

Polar intensity diagram

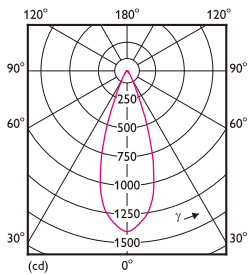

Cartesian intensity diagram

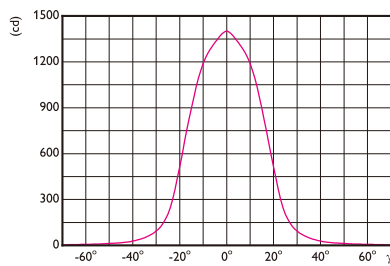

Beam diagram

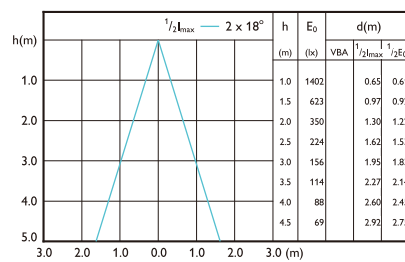

Visual impact diagram

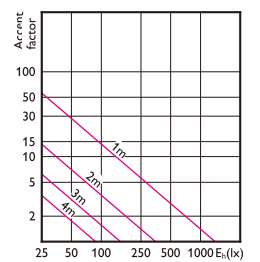

MASTER LED 6.5-50W 927 MR16 60D Dim

1 x 500 lm

Light output ratio	1.00	I_{max}	462 cd
Service upward	0.00	$BS (\frac{1}{2} I_{max})$	$2 \times 31^\circ$
Service downward	1.00	$BS (\frac{1}{2} E_0)$	$2 \times 25^\circ$

Polar intensity diagram

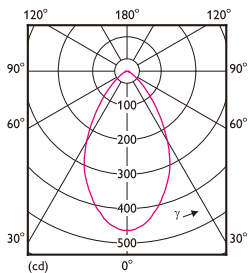

Cartesian intensity diagram

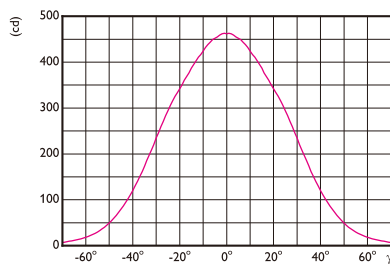

Beam diagram

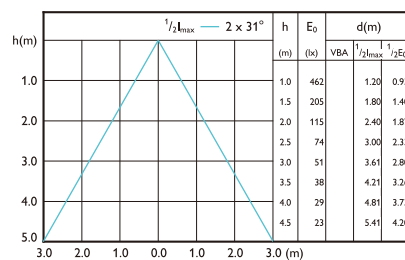

Visual impact diagram

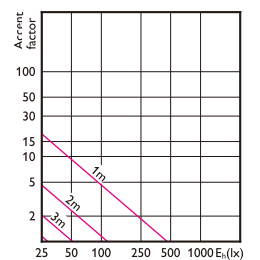

MASTER LED 6.5-50W 930 MR16 60D Dim

1 x 500 lm

Light output ratio	1.00	I_{max}	462 cd
Service upward	0.00	BS ($\frac{1}{2} I_{max}$)	$2 \times 31^\circ$
Service downward	1.00	BS ($\frac{1}{2} E_0$)	$2 \times 25^\circ$

Polar intensity diagram

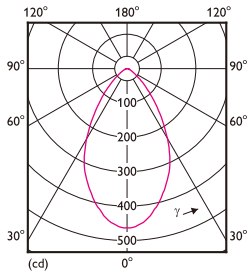

Cartesian intensity diagram

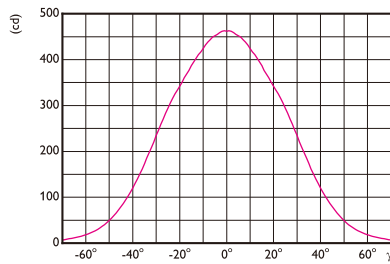

Beam diagram

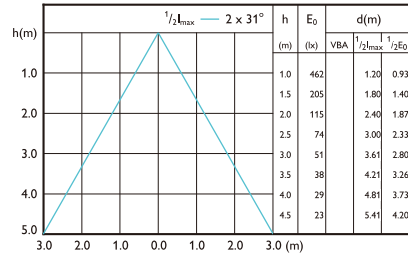

Visual impact diagram

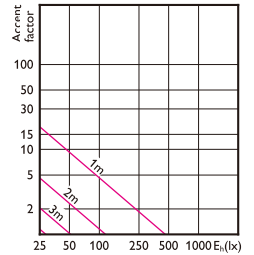

MASTER LED 6.5-50W 940 MR16 60D Dim

1 x 530 lm

Light output ratio	1.00	I_{max}	490 cd
Service upward	0.00	BS ($\frac{1}{2} I_{max}$)	$2 \times 31^\circ$
Service downward	1.00	BS ($\frac{1}{2} E_0$)	$2 \times 25^\circ$

Polar intensity diagram

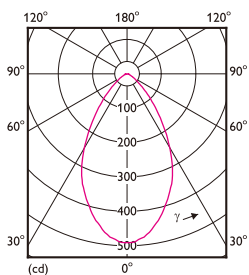

Cartesian intensity diagram

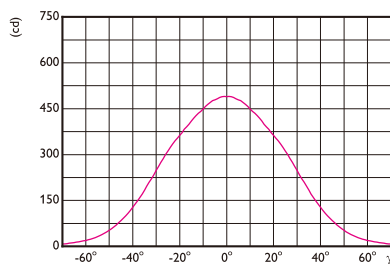

Beam diagram

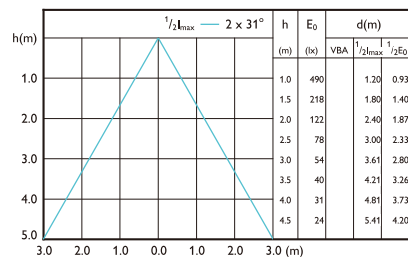

Visual impact diagram

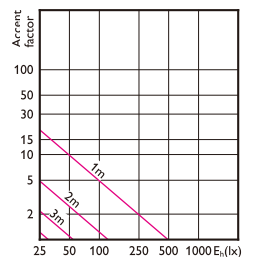

Lifetime + Sustainability

Failure Rate Curve of LED 6.5W

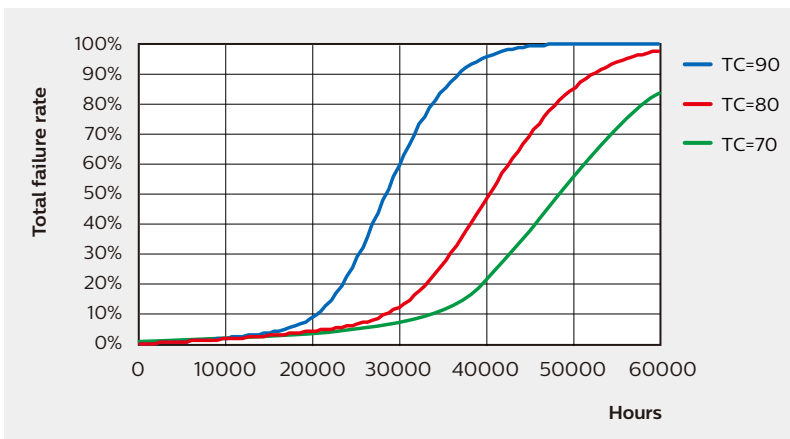

- Philips LED MR16 lamp has a lifetime of 40,000 hours, defined as the number of hours when 50% of a large group of identical lamps below 70% of its initial lumens.
- Lifetime estimation based on the application environment condition: at room temperature (25°C@ 10mm free air), base down burning position, and at rated voltage.

Master LED 6.5W Lifetime Vs Tc

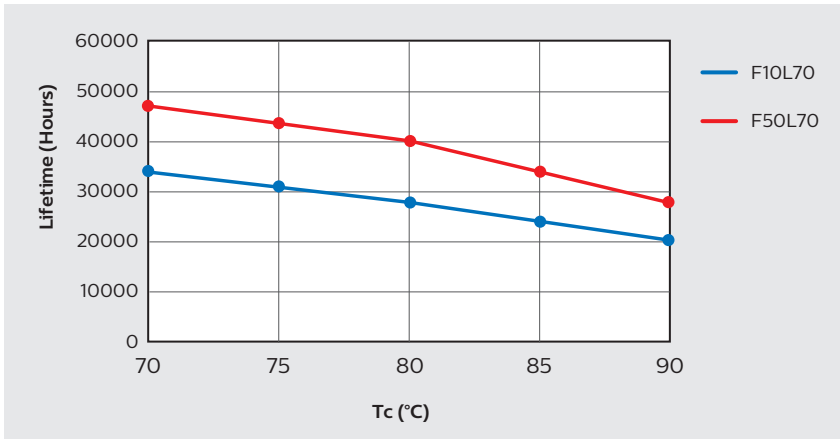

Installation Guide

Philips LED 6.5W MR16 lamp has a unique, patented, electronic solution that makes this LED Replacement lamp compatible with the broadest possible range of standard 12VAC Halogen electronic transformers in the global market place except for some IC-base transformers WHEN the whole system is without dimmers. Compatibility with electromagnetic transformers is guaranteed as well. To determine the maximum number of these LED MR16 lamps to be connected to a standard halogen transformer, is by simply dividing 40% of the rated power of the transformer by LED lamp wattage.

Thus, a 60W Halogen transformer will hold Master Premium LED Spot 6.5W up to INT $(60 \times 40\% / 6.5) = 3$ lamps.

1. Determine the max. number of lamps can be connected to a ET, 40% power derating of ET should be considered
2. For dimming system, you can install for each dimmer

Example:

1. W (or VA) * 40% of ET to determine max. lamps per transformer



Transformer: Light Tech LET60
 Pout: 60W max
 $60W \times 40\% / 6.5W \sim 3$
 3 x 6.5W lamps max. per transformer

2. The rated power of the dimmer and the transformer is to determine the max. numbers of the transformers per dimmer

Max. number of transformers:
 $200W / 60W = 3.33 \rightarrow 3$ transformer per dimmer

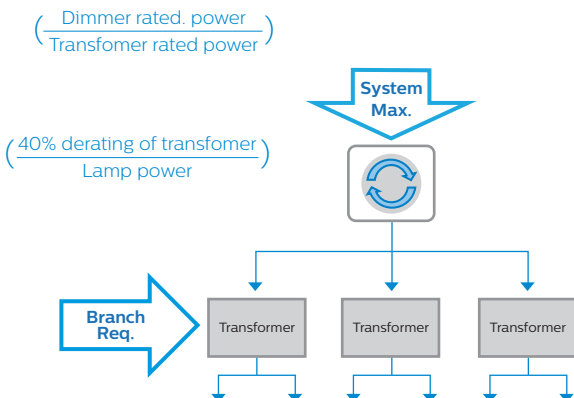
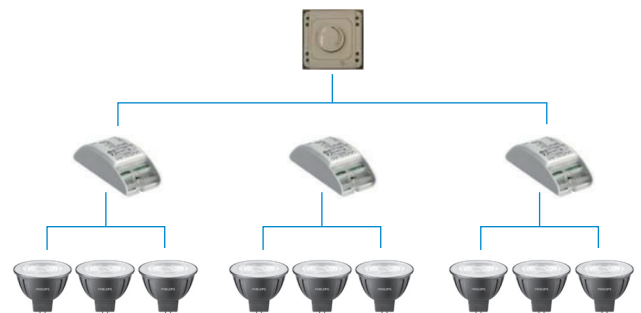

Compatibility list

		Transformer											
		Philips					OSRAM		NVC	Opplé	ENDO	Daiko	
Model		ET-E60	ET-E10 LED	ETS15 LED	ET-C60	ET-S60	ET-P60	ECO-ET60	ET60E	DB602	X224B	DP36283	
Region		APR					APR		APR	APR	APR	APR	
min. load		20	2	2	20	20	20	20	20	20	35	10	
max. load		60	10	15	60	60	60	60	60	60	75	75	
Without Dimmer		1 lamp	1 lamp	1 lamp	2 lamps	1 lamp	1 lamp	1 lamp	1 lamp	1 lamp	1 lamp	1 lamp	
Brand	Model												
APR Dimmer	Clipsal	3031H500MK										NR	NR
		32E450UDM										NR	NR
		32v500										NR	NR
		KB31RD400										NR	NR
	TNC	Z62-M12									NR	NR	
	PDL	624TMWH									NR	NR	
	Panasonic	NQ 20345	NR	NR	NR	NR	NR	NR	NR	NR			
	KIWI	K005T										NR	NR
		K004U										NR	NR
	Daiko	DP-34401	NR	NR	NR	NR	NR	NR	NR	NR	NR		

- x-y Dimmer and transformer are compatible with x - y lamp.
- Dimmer and transformer are compatible but will not work according claimed specifications under all conditions.
- Dimmer and transformer are not compatible and therefore will not comply according claimed specifications.
- N. A. Dimmer, transformer and lamp combination not applicable/relevant.
- T.B.D. Dimmer, transformer and lamp combination not tested.



© 2021 Signify
 All rights reserved. Reproduction in whole or in part is prohibited without the prior written consent of the copyright owner. The information presented in this document does not form part of any quotation or contract, is believed to be accurate and reliable and may be changed without notice. No liability will be accepted by the publisher for any consequence of its use. Publication thereof does not convey nor imply any license under patent or other industrial or intellectual property rights.