

Product Description

LF-GIF040YA II is a 40W flicker free LED driver for external assembly. Input voltage range: 220-240Vac; output current range: 850-1000mA.

Feature

- Suitable for Class II light fixtures
- Flicker free
- High efficiency, low THD
- 5-year warranty (Please refer to the warranty condition.)

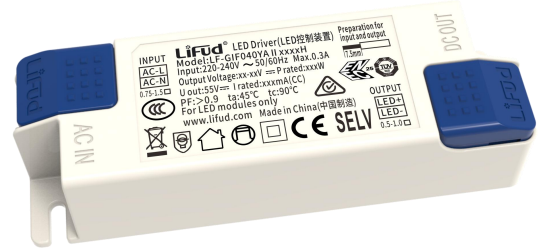

Application

- Commercial lighting
- Decorative lighting
- Indoor office lighting
- Residential lighting



Product Naming

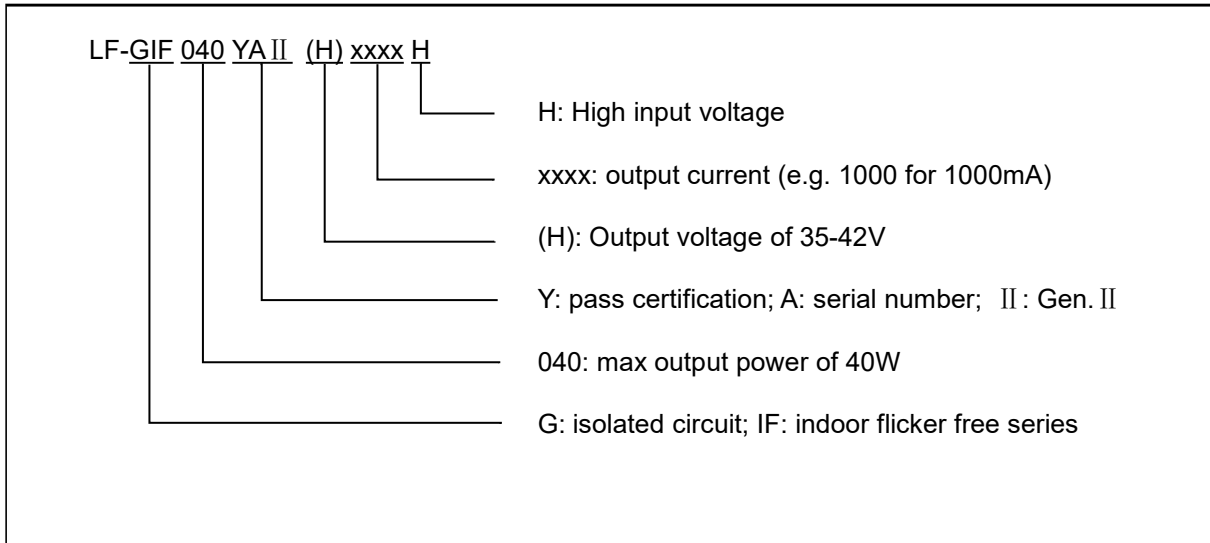

Electrical Characteristics

Model		LF-GIF040YA II				LF-GIF040YA II (H)
Output	Output Voltage	33-40V				35-42V
	Output Current	850mA	900mA	950mA	1000mA	1000mA
	Percent Flicker (Modulation Depth)	<0.5%				
	Ripple Current	<10%				
	Current Tolerance	±5%				
	Temperature Drift	±10%				
	Start-up Time	<0.5S@230Vac				
Input	Input Voltage	220-240Vac (voltage limit: 200-264Vac)				
	Input Frequency	47Hz-63Hz				
	Input Current	0.3A Max.				
	Power Factor	≥0.95@230Vac				
	THD	≤15%@230Vac				
	Efficiency	≥90%@230Vac				
	Inrush Current	≤60A & 350uS @230Vac				
	Load Quantity Carried by the Circuit Breaker	Circuit Breaker Model	B10	C10	B16	C16
		Quantity (pcs)	23	27	37	43
	Leakage Current	≤0.7mA				
Standby Power Consumption	≤0.5W					
Protection Characteristics	Open Circuit Protection	<55V				
	Short Circuit Protection	Hiccup mode (auto-recovery)				
Environment Description	Working Temperature	-30℃~+45℃				-30℃~+40℃
	Working Humidity	20-90%RH (no condensation)				
	Storage Temperature/Humidity	-50℃~+ 85℃ (six months under class I environment);				
		10-95%RH (no condensation)				
Atmospheric Pressure	86KPa~106KPa					

Safety & Electromagnetic Compatibility	Certifications	ENEC, CE, CB, RCM, CCC
	Withstanding Voltage	I/P-O/P: 3.75KV, 5mA, 60S; I/P-PG: 1.5kV 5mA 60S
	Insulation Resistance	I/P-O/P: >100MΩ @ 500Vdc
	Safety Standards	ENEC: EN61347-1:2015, EN 61347-2-13:2014/A1:2017, EN 62384: 2016/A1:2009 CE-LVD: EN 61347-2-13:2014/A1:2017, EN 61347-1:2015, EN 62493:2015 CB:IEC 61347-1:2015, IEC61347-2-3:2014, IEC 61347-2-13:2014/AMD1:2016 CCC:GB19510.1-2009, GB19510.14-2009
	EMI	CE-EMC/RCM:EN55015,EN61000-3-2,EN61000-3-3 CCC:GB/T17743,GB17625.1,GB17625.2
	EMS	CE-EMC/RCM: EN61000-4-2,3,4,5(lightning strike 1KV),6,11 CCC:GB/T17626.2,3,4,5(lightning strike 1KV),6,11
Others	IP Rating	/
	RoHS	RoHS 2.0 (EU) 2015/863
	Warranty Condition	5 yrs (TC≤82℃)
Remarks	<ol style="list-style-type: none"> 1. It is recommended that customer should install overvoltage and undervoltage protection devices and surge protection devices in the power supply circuits of the light fixtures to ensure safety before connecting to electricity. 2. As an accessory, the LED driver is not the only factor determining the EMC performance of the LED light fixture. The structure and the wiring of the light fixture are also relevant. Thus it's strongly recommended the LED light fixture manufacturer should re-confirm the EMC of the whole LED light fixture. 3. The test conditions of the circuit breaker configuration quantity are the same as those of the inrush current test. 4. Unless otherwise stated, the parameters above are test results under these conditions: ambient temperature 25℃, humidity 50%, 100% load and input voltage 230Vac. 	

Product Characteristic Curves

■ **PF Curve**

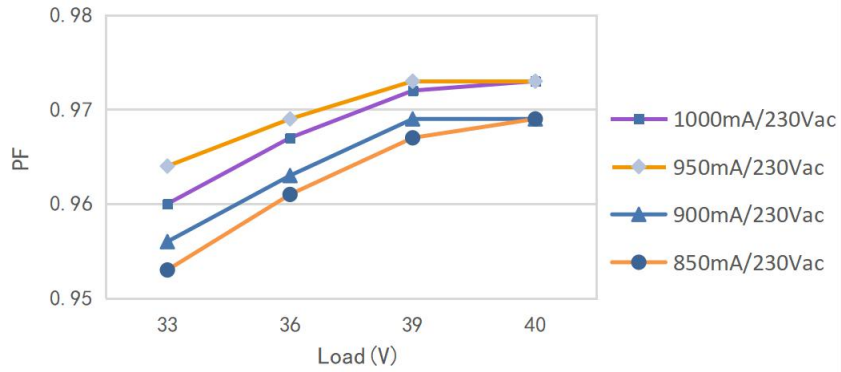

■ **Efficiency Curve**

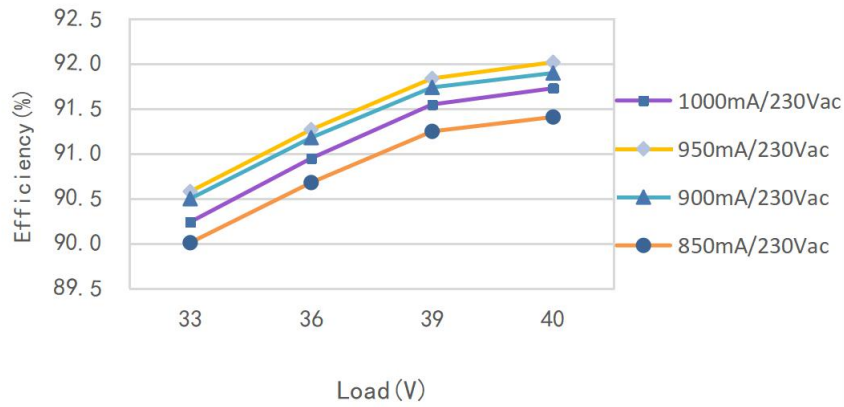

■ **Lifetime Curve**

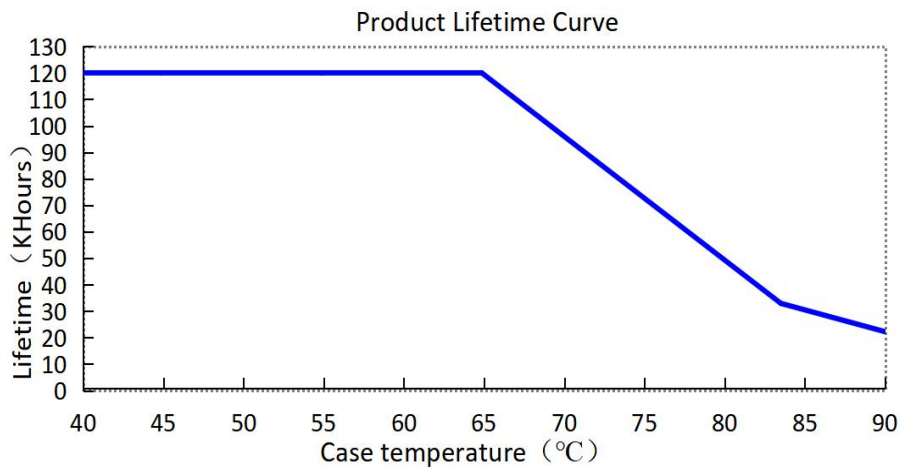

Definition of the Driver's Terminal

INPUT

AC-L	Input terminal of AC live wire
AC-N	Input terminal of AC neutral wire

OUTPUT

LED+	Positive electrode output of the driver
LED-	Negative electrode output of the driver

Label

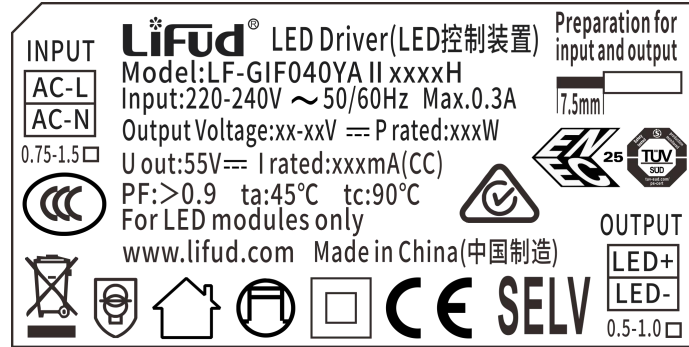

Structures & Dimensions (Unit: mm)

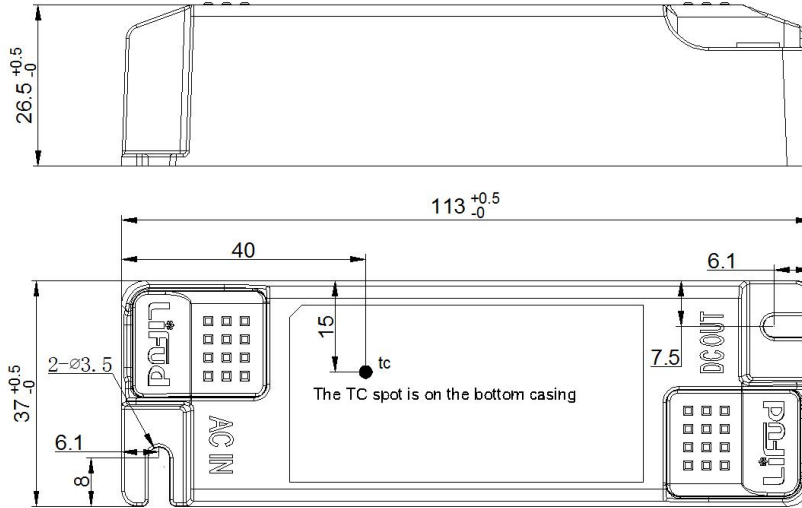

Packaging Specifications

Model	LF-GIF040YA II xxxxH
Packaging Dimensions	385*285*210 mm (L*W*H)
Quantities	14 pcs/layer; 7 layers/ctn; 98 pcs/ctn
Weights	82 g/pc; 8.28 kg/ctn

Transportation & Storage

■ Transportation

- Suitable transportation means: vehicles, boats and aircraft.
- During transportation, there should be awnings for rain protection and sun protection. Civilized loading and unloading are required. There should be no severe vibration or impact.

■ Storage

- Storage in accordance with the provisions of Class I environment. For products which have been stored for more than six months, they mustn't be used until they pass the re-inspection.

Attention

- Please use this product according to its specifications otherwise there may be malfunction.
- Use light fixtures that have not been certified or are not compatible with the LED drivers may cause fire or other hazards.
- Man-made damage, any use beyond the specification and non-original-factory modification are not covered by warranty.

Remark: The final interpretation right of the contents of this data sheet belongs to Lifud Technology Co., Ltd.

