

Mercmaster™ LED Low Profile Luminaires

Enclosed and Gasketed Fixtures

NEC/CEC:
 Class I, Division 2, Groups A,B,C,D
 Class I, Zone 2, AEx ec IIC
 Zone 21, AEx tb IIIC
 Class I, Zone 2 Ex ec II
 Class II, Division 1, Groups E,F,G
 Zone 20, Group IIIC
 Class II, Division 2, Groups F,G
 Class III

NEC/CEC:
 Type 3R, 4, 4X
 IP66/IP67
 Simultaneous Exposure
 Suitable for Use in Wet Locations
 Marine Outside Type (Salt Water) For USA ONLY ⚠
 American Bureau of Shipping (ABS) Certified
 International Dark Sky (IDA) Approved

ATEX:
 Zone 2 and 21-22
 II 2 D
 II 3 GD
 IP66
 IK08

IECEX:
 Zone 2 and 21-22
 Ex ec IIC
 Ex op is tb IIIC
 Ex tc IIIC
 IP66
 IK08

Applications

- Enclosed and gasketed fixtures suitable for use in:
 - A wide range of industrial, chemical processing and other areas where flammable gases, vapors and combustible dusts are present including simultaneous exposure
 - Marine and wet locations
 - Areas of low clearance, low ceiling heights or where fixture weights must be minimized
- Typical applications include:
 - Walkways/catwalks
 - Stairwells
 - Grain elevators
 - Tunnels
 - Pipe racks
 - Offshore rigs
 - Vessel lighting
 - Cooling towers
 - Processing areas

Features

- Choice of color temperature (CCT): 5000K cool white, 4000K neutral white or 3000K warm white.
- Seven standard mounting hood designs allow for mounting in any location. Uses same mounting hoods as Mercmaster™ III, Mercmaster™ Premium LED and Mercmaster™ LED Generation 3.
- Customize to the application requirements with four different field replaceable globe options: clear and diffused polycarbonate, clear glass, or prismatic glass refractor.
- Three light output levels for retrofit of HID fixtures up to 175 W.

Nominal Lumens ①	HID Equivalent	Model Number
3300	70-100W	MLLED2CG5BU
4400	100-150W	MLLED3CG5BU
5500	150-175W	MLLED4CG5BU

- Retrofit adapters for Crouse Hinds™ hood available. See Mercmaster CH Adapters.
- Retrofit adapters for Mercmaster II hoods available. See Mercmaster II Adapters.
- Retrofit adapter for Killark™ hoods available. See Killark™ Adapter.
- New Watertight Pendant Hood available to address water ingress into luminaire via conduit.
- Hinge has high lip for added safety during installation and servicing. Hinge and bolt construction assures 360° compression at all points on fixture housing gasket for positive sealing. Swing away design of captive bolt and nut simplifies servicing.
- Standard 6 kV surge protection.
- Ambient Temperature: BU: -40 °C to +65 °C (-40 °F to +149 °F)
 BH: -40 °C up to +65 °C (-40 °F up to +149 °F)
- Standard screw-type terminal block can accept UL/CSA 26-10 AWG wire.
- Heavy duty, high temperature silicone rubber gaskets.

① Prismatic glass refractor is cCSAus certified only.

② Nominal Lumen value for 5000K CCT, clear glass globe. Detailed lumen information is provided in tables.

③ Factory installed. Fusing only permitted for cCSAus rating. (For retrofit applications, fusing must be removed from the mounting hood and ordered in the luminaire).

④ Available for 120-277 VAC models only. NEC, Class I, Division 2 photocells for classified use are available, see PCD2 Series.

⑤ Mounting hoods with photocontrols are not rated IP66, Type 4X or Marine Outside Type (Salt Water), or rated Class II, but are suitable for wet locations.

⚠ Use of fuse voids Marine Outside Type (Salt Water) rating.

✦ Killark is a registered trademark of Hubbell Incorporated

✦ Crouse-Hinds is a registered trademarks of Cooper Crouse-Hinds.



- Standard NPT threads.
- LED L70 rated at 109,000 Hours with a calculated fixture life of 200,000 hours @ +25 °C (+77 °C).
- Field replaceable globes and LED driver.
- Rugged housing with superior thermal design translates to long luminaire life.
- Photobiological Safety, per IEC standards

Options

- Glass globe and glass refractor guard available, purchase separately.
- All Mercmaster™ luminaires have provision for fusing; add suffix **-F** at the end of the catalog number. ③
- Photocontrols are available with all except ceiling and pendant cone mounting hoods. Add suffix **-1** for 120V, **-2** for 208V, **-3** for 240V, **-4** for 277V. ④

Standard Materials

- Mounting hoods and bodies: cast copperfree (4/10 of 1% max.) aluminum
- All hardware and catch assemblies: stainless steel
- Globe: polycarbonate or glass
- Refractor: heat-resistant prismatic glass
- Glass globe guard: stainless steel wire
- Glass refractor guard: die cast aluminum
- Reflector: fiberglass reinforced white polyester

Standard Finishes

- Mounting hoods, bodies and glass refractor guard: gray epoxy powder coat finish, electrostatically applied for complete uniform protection

NEC/CEC Certifications and Compliances

- UL Standard: UL 50E, Second Edition; UL 844, Thirteenth Edition; UL 1598, Third Edition; UL 1598A, First Edition; UL 8750, Second Edition;
- CSA Standard: C22.2 No 0-10; C22.2 No. 94.2-15; C22.2 No. E60598-1:16; C22.2 No. 137-M1981; C22.2 No. 250.0-08; C22.2 No. 250.13-14
- ANSI/IEC Standard: 60529
- cCSAus Listed: 164460

Mercmaster™ LED Low Profile Luminaires

Enclosed and Gasketed Fixtures

NEC/CEC:
 Class I, Division 2, Groups A,B,C,D
 Class I, Zone 2, AEx ec IIC
 Zone 21, AEx tb IIIC
 Class I, Zone 2 Ex ec II
 Class II, Division 1, Groups E,F,G
 Zone 20, Group IIIC
 Class II, Division 2, Groups F,G
 Class III

NEC/CEC:
 Type 3R, 4, 4X
 IP66/IP67
 Simultaneous Exposure
 Suitable for Use in Wet Locations
 Marine Outside Type (Salt Water) For USA ONLY ‡
 American Bureau of Shipping (ABS) Certified
 International Dark Sky (IDA) Approved

ATEX:
 Zone 2 and 21-22
 II 2 D
 II 3 GD
 IP66
 IK08

IECEX:
 Zone 2 and 21-22
 Ex ec IIC
 Ex op is tb IIIC
 Ex tc IIIC
 IP66
 IK08

ATEX/IECEX Certifications and Compliances

- Certification Type: Mercmaster™ Low Profile
 - Gas: Zones 2
 - Conforming to ATEX 2014/34/EU: II 3 G
 - Type of Protection: Ex ec IIC T* Gc
 - Temperature Class: T5 to T4
 - Dust: Zones 21 and 22
 - Conforming to ATEX 2014/34/EU: II 2 D
 - Type of Protection: Ex op is tb IIIC T**C Db, Ex tc IIIC T**C Dc
 - Surface Temperature: +66 °C to +88 °C (+151 °F to +190 °F)
- Ambient Temperature: -40 °C up to +65 °C (-40 °F up to 149 °F)

- ATEX Certificate: Sira 17ATEX9365X
- IECEX Certificate: IECEX SIR 17.0085X
- Index of Protection according EN/IEC 60529: IP66
- Impact Resistance (shock): IK08
- Photobiological Safety, IEC 62778 and IEC 62471

DesignLights™ Consortium

- Check DLC QPL for current list of products.

International Dark-Sky Association

- IDA Dark Sky Approved when ordering [I]MLLED[A/B/C/D/R/W] xxW[P/D/G]5Bxxx with MMVISOR accessory

Illustrated Features

Heatsink

Reliable heat transfer via the cast, epoxy powder coat aluminum body. Provides maximum heat dissipation from the LED assembly to the outside environment.

Fuses (optional)

Fuses factory installed in luminaire housing ①. Use of fuse voids Marine Outside Type (salt water) rating.



Driver Assembly

Utilizing non-sparking components avoiding the ignition of gases or vapors that may be present.



Cooler Operating Cone Hood

Larger sloped surface sheds dusts, dirt and combustible fibers providing better heat dissipation.



Watertight Pendant Hood

Redesigned Pendant hood provides protection against water ingress in the conduit utilizing an IP 68 cord grip with three wire holes 4mm in diameter.

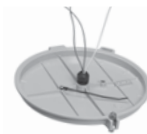

Photocell (optional)

Factory Installed in the Mounting Hood. Available for all fixtures ② except cone and ceiling mount. Provides continuous ON-OFF dusk-to-dawn control. *Note: Fixtures with PCD2 photocontrols are not rated IP66, Type 4X, Marine Outside Type (Salt Water), but are suitable for wet locations.*

Terminal Blocks

A seven-point terminal block is provided to facilitate wiring. Terminal block accommodates wire size ranging from 26-10 AWG.

Epoxy Finish

Fixture housing, hoods and guards are copperfree aluminum with triple protection epoxy powder coat finish.

Electrical Protection

Ground wire provided to bond mounting hood to fixture housing. External Grounding provision for additional safety.

Reflectors and Visors

Reflectors are thick, tough fiberglass reinforced white polyester. Visor is aluminum with electrostatically applied, gray epoxy powder coat finish. Quickly attach either accessory to luminaire with furnished stainless steel screws.



Mounting Hood and Globe Gaskets

Silicone rubber gaskets seal out moisture, dirt and dust. Stays flexible, withstands extreme temperatures. Closure design assures uniform gasket compression.

Stainless Steel Latch Assembly

Captive, stainless steel latch assembly bolt and nut closes securely, resists attack of corrosive atmospheres. Swing-away design simplifies servicing.



Prismatic Refractors

Heat-resistant refractor threads directly into fixture housing and seal against a high-temperature silicone rubber gasket.



“Safety” Cable

Safety cable option threads through the fixture housing for additional safety.



“Safety” High Hinge

Extra-high hinge provides additional protection against accidental fixture housing disengagement during installation or maintenance.

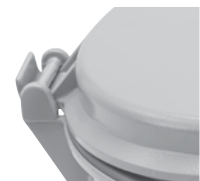

* Refer to ambient range table which is contained in the IECEX certificate of conformity file or the catalog pages for T-code ratings.

① Factory Installed. Fusing only permitted for cCSAus rating.

② Available for 120-277 VAC models only.

‡ Use of fuse voids Marine Outside Type (Salt Water) rating.

Mercmaster™ LED Low Profile Luminaires

Enclosed and Gasketed Fixtures

NEC/CEC:

Class I, Division 2, Groups A,B,C,D
 Class I, Zone 2, AEx ec IIC
 Zone 21, AEx tb IIIC
 Class I, Zone 2 Ex ec II
 Class II, Division 1, Groups E,F,G
 Zone 20, Group IIIC
 Class II, Division 2, Groups F,G
 Class III

NEC/CEC:

Type 3R, 4, 4X
 IP66/IP67
 Simultaneous Exposure
 Suitable for Use in Wet Locations
 Marine Outside Type (Salt Water) For USA ONLY ⌘
 American Bureau of Shipping (ABS) Certified
 International Dark Sky (IDA) Approved

ATEX:

Zone 2 and 21-22
 II 2 D
 II 3 GD
 IP66
 IK08

IECEX:

Zone 2 and 21-22
 Ex ec IIC
 Ex op is tb IIIC
 Ex tc IIIC
 IP66
 IK08

Mercmaster™ LED Low Profile Family Tree

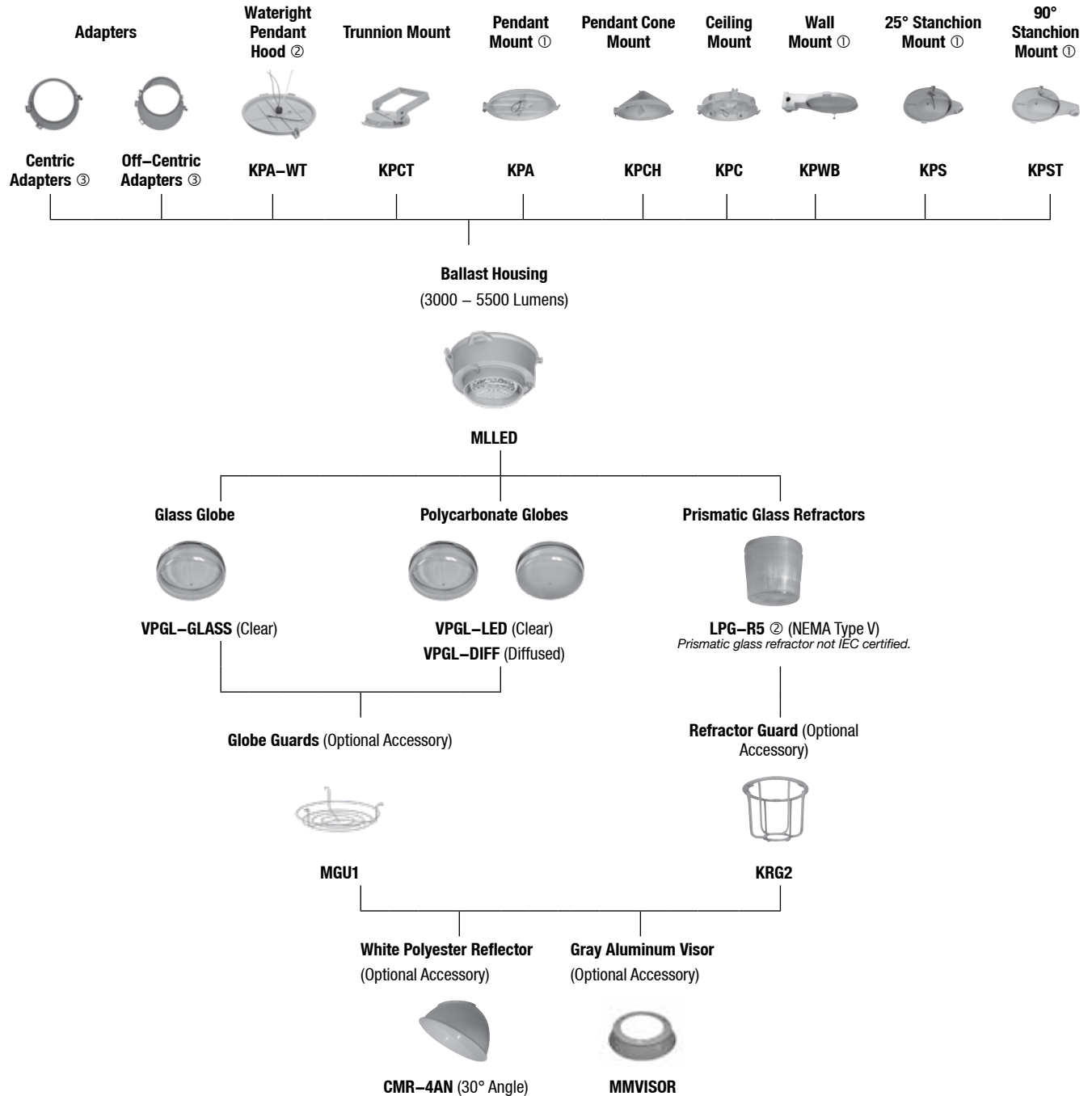

① Mounting hood with a 120 V or 208-277 V factory installed photocell is available.

② Certified for cCSAus only.

③ See mounting hood section for part numbers.

⌘ Use of fuse voids Marine Outside Type (Salt Water) rating.

Mercmaster™ LED Low Profile Luminaires

Enclosed and Gasketed Fixtures

NEC/CEC:

Class I, Division 2, Groups A,B,C,D
 Class I, Zone 2, AEx ec IIC
 Zone 21, AEx tb IIIC
 Class I, Zone 2 Ex ec II
 Class II, Division 1, Groups E,F,G
 Zone 20, Group IIIC
 Class II, Division 2, Groups F,G
 Class III

NEC/CEC:

Type 3R, 4, 4X
 IP66/IP67
 Simultaneous Exposure
 Suitable for Use in Wet Locations
 Marine Outside Type (Salt Water) For USA ONLY ⌘
 American Bureau of Shipping (ABS) Certified
 International Dark Sky (IDA) Approved

ATEX:

Zone 2 and 21-22
 Ⓢ II 2 D
 Ⓢ II 3 GD
 IP66
 IK08

IECEX:

Zone 2 and 21-22
 Ex ec IIC
 Ex op is tb IIIC
 Ex tc IIIC
 IP66
 IK08

Order using catalog numbering guides below or select catalog number from tables on following pages.

Catalog Numbering Guide

For Hazardous Locations:

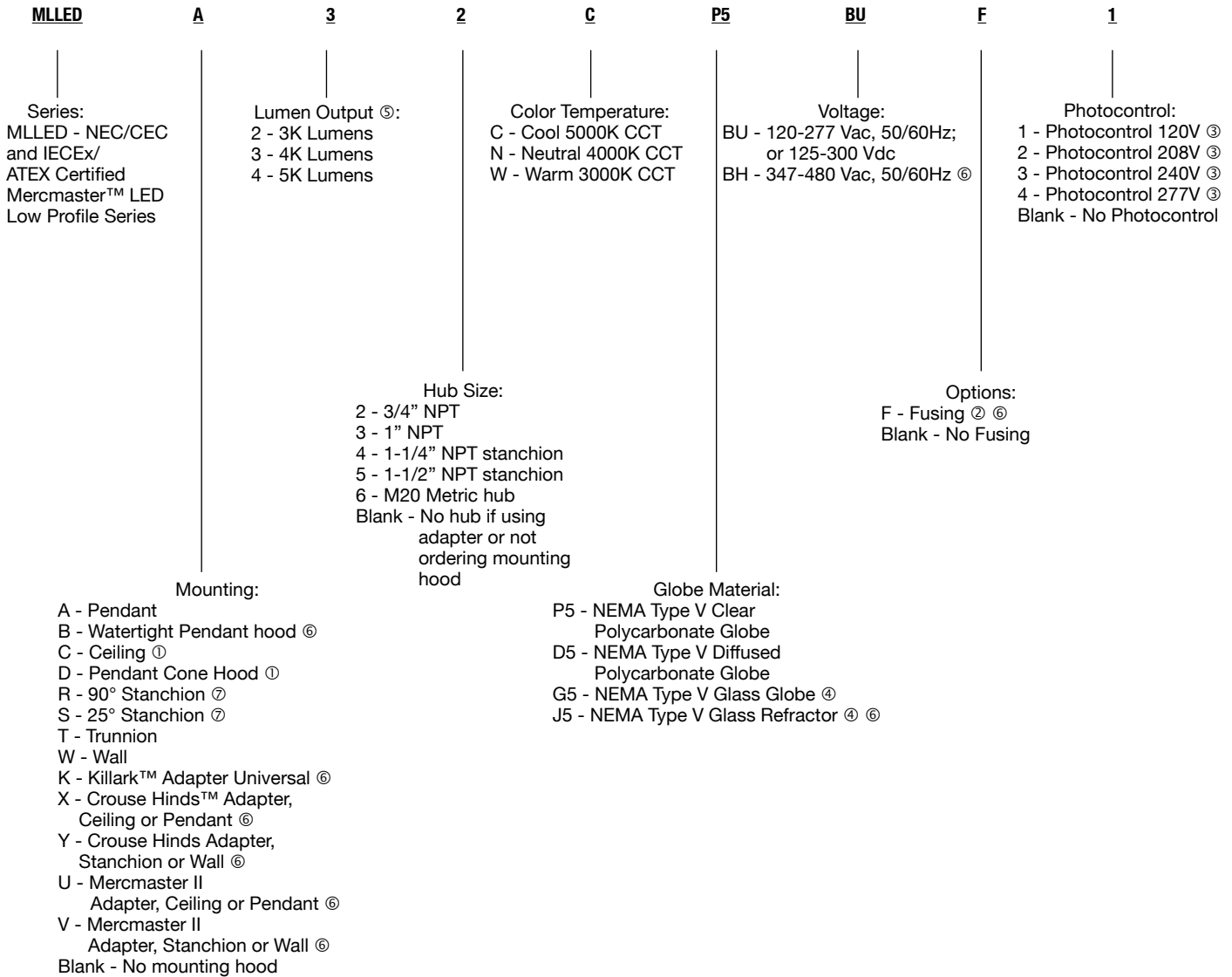

① Ceiling and pendant cone hood mounted luminaires are not designed to use the PCD2 photocontrol. Ceiling mounts can be used with a FS/FD box with a photocontrol. Contact your local sales representative for more information.
 ② Factory installed. Fusing is mounted in the driver housing. (For retrofit applications that require fusing, fusing must be removed from the mounting hood and ordered in the luminaire). Fusing only permitted for cCSAus rating.
 ③ Luminaires with photocontrol are not rated IP66/67, Marine Outside Type (Salt Water), or Class II and voids the NEMA ratings on the fixture but remains suitable for use in wet locations. Photocontrol available for 120-277 VAC only.
 ④ Guards for the glass refractors and globes are ordered separately. See the Accessories for more information.
 ⑤ For specific lumen output information, see Lamp Comparison Chart.
 ⑥ Certified for cCSAus only.
 ⑦ 3/4" NPT, 1" NPT and Metric M20 hub entries not offered in this mounting option.
 ⌘ Use of fuse voids Marine Outside Type (Salt Water) rating.

Mercmaster™ LED Low Profile Luminaires

Enclosed and Gasketed Fixtures

NEC/CEC:

Class I, Division 2, Groups A,B,C,D
 Class I, Zone 2, AEx ec IIC
 Zone 21, AEx tb IIIC
 Class I, Zone 2 Ex ec II
 Class II, Division 1, Groups E,F,G
 Zone 20, Group IIIC
 Class II, Division 2, Groups F,G
 Class III

NEC/CEC:

Type 3R, 4, 4X
 IP66/IP67
 Simultaneous Exposure
 Suitable for Use in Wet Locations
 Marine Outside Type (Salt Water) For USA ONLY ⚠
 American Bureau of Shipping (ABS) Certified
 International Dark Sky (IDA) Approved

ATEX:

Zone 2 and 21-22
 II 2 D
 II 3 GD
 IP66
 IK08

IECEX:

Zone 2 and 21-22
 Ex ec IIC
 Ex op is tb IIIC
 Ex tc IIIC
 IP66
 IK08

NEC/CEC Temperature Codes

Lamp		NEC/CEC							Gas/Dust
Model	Type	Ambient Temperature °C (°F)	Supply Wire Temperature °C (°F)	Gas		Dust		Simultaneous ① Class I, Division 2/ Class II, Division 1	
				Class I, Division 2 Groups A, B, C, D ①	Class I, Zone 2 Group IIC	Class II, Division 1, Groups E, F and G ②	Zone 21, Group IIIC		
MLLED2	LED	40 (104)	90 (194)	T5	T5	T6	T6	T5	
	LED	55 (131)	90 (194)	T5	T5	T6	T6	T5	
MLLED3	LED	65 (149)	90 (194)	T4A	T4	T6	T6	T4A	
	LED	40 (104)	90 (194)	T4A	T4	T6	T6	T4A	
	LED	55 (131)	90 (194)	T4A	T4	T6	T6	T4A	
	LED	65 (149)	90 (194)	T4A	T4	T5	T5	T4A	
MLLED4	LED	40 (104)	90 (194)	T4A	T4	T6	T6	T4A	
	LED	55 (131)	90 (194)	T4	T4	T6	T5	T4	
	LED	65 (149)	90 (194)	T4	T4	T5	T5	T4	

ATEX/IECEX Temperature Codes

Model Number	Gas T Rating			Dust Surface T°		
	Ta= +40 °C (+104 °F)	Ta= +55 °C (+131 °F)	Ta= +65 °C (+149 °F)	Ta= +40 °C (+104 °F)	Ta= +55 °C (+131 °F)	Ta= +65 °C (+149 °F)
MLLED2	T5	T5	T4	T66°C	T79°C	T88°C
MLLED3	T4	T4	T4	T66°C	T79°C	T88°C
MLLED4	T4	T4	T4	T66°C	T79°C	T88°C

Ambient Temperature Range: -40 °C to +65 °C (-40 °F to +149 °F)

“T” Numbers Represent the Maximum Internal Temperature ① or Maximum Surface Temperature ②

“T” #	NEC/CEC															
	T1	350	325	T2	T2A	T2B	T2C	T2D	T3	T3A	T3B	T3C	T4	T4A	T5	T6
Temp. Range °C (°F)	351-450 (664-842)	326-350 (619-662)	301-325 (574-617)	281-300 (538-572)	261-280 (502-536)	231-260 (448-500)	216-230 (421-446)	201-215 (394-419)	181-200 (358-392)	166-180 (331-356)	161-165 (322-329)	136-160 (277-320)	121-135 (250-275)	101-120 (214-248)	86-100 (187-212)	85 (185)
“T” #	ATEX/IECEX															
	T1			T2				T3			T4		T5	T6		
Temp. Range °C (°F)	301-450 (547-842)			201-300 (394-572)				136-200 (277-392)			101-135 (214-275)		86-100 (187-212)	85 (185)		

① T numbers represent the maximum internal temperature for Class I, Division 2 and Class I, Zone 2 locations designated by the NEC, and Zone 2, 21 and 22 locations designated by ATEX/IECEX.

② T numbers represent the maximum surface temperature under a dust blanket for Class II, Division 1 and 2 as designated by the NEC, and Zone 2, 21 and 22 locations designated by ATEX/IECEX.

⚠ Use of fuse voids Marine Outside Type (Salt Water) rating.

Mercmaster™ LED Low Profile Luminaires

Enclosed and Gasketed Fixtures

NEC/CEC:
 Class I, Division 2, Groups A,B,C,D
 Class I, Zone 2, AEx ec IIC
 Zone 21, AEx tb IIIC
 Class I, Zone 2 Ex ec II
 Class II, Division 1, Groups E,F,G
 Zone 20, Group IIIC
 Class II, Division 2, Groups F,G
 Class III

NEC/CEC:
 Type 3R, 4, 4X
 IP66/IP67
 Simultaneous Exposure
 Suitable for Use in Wet Locations
 Marine Outside Type (Salt Water) For USA ONLY ⌘
 American Bureau of Shipping (ABS) Certified
 International Dark Sky (IDA) Approved

ATEX:
 Zone 2 and 21-22
 II 2 D
 II 3 GD
 IP66
 IK08

IECEX:
 Zone 2 and 21-22
 Ex ec IIC
 Ex op is tb IIIC
 Ex tc IIIC
 IP66
 IK08

Lumen Values Table ①②

Model	Lumens ①			Type V Prismatic Glass Refractor	CRI ②	Color Temp CCT	Equivalent HID Luminaire
	Polycarbonate Clear Globe	Polycarbonate Diffused Globe	Glass Clear Globe				
NEMA Type V							
MLLED2	3200	3100	3300	3000			70-100W
MLLED3	4200	4100	4400	4000	>70	5000K	100-150W
MLLED4	5300	5150	5500	4900			150-175W
NEMA Type V							
MLLED2	3000	2900	3100	2800			70-100W
MLLED3	4000	3900	4200	3800	>70	4000K	100-150W
MLLED4	5000	4900	5200	4650			150-175W
NEMA Type V							
MLLED2	3000	2900	3100	2800			70-100W
MLLED3	3900	3800	4100	3700	>70	3000K	100-150W
MLLED4	4900	4800	5100	4600			150-175W

① All lumen values are typical (tolerance +/- 10%).

② 70 minimum.

⌘ Use of fuse voids Marine Outside Type (Salt Water) rating.

Mercmaster™ LED Low Profile Luminaires

Enclosed and Gasketed Fixtures

NEC/CEC:

Class I, Division 2, Groups A,B,C,D
 Class I, Zone 2, AEx ec IIC
 Zone 21, AEx tb IIIC
 Class I, Zone 2 Ex ec II
 Class II, Division 1, Groups E,F,G
 Zone 20, Group IIIC
 Class II, Division 2, Groups F,G
 Class III

NEC/CEC:

Type 3R, 4, 4X
 IP66/IP67
 Simultaneous Exposure
 Suitable for Use in Wet Locations
 Marine Outside Type (Salt Water) For USA ONLY †
 American Bureau of Shipping (ABS) Certified
 International Dark Sky (IDA) Approved

ATEX:

Zone 2 and 21-22
 II 2 D
 II 3 GD
 IP66
 IK08

IECEX:

Zone 2 and 21-22
 Ex ec IIC
 Ex op is tb IIIC
 Ex tc IIIC
 IP66
 IK08

Electrical Ratings ①

Model	Voltage	Input Power (Watts)	Input Current (Amps)	Power Factor (PF)	Total Harmonic Distortion (THD)
MLLED2	120 Vac	28.0	.28	> .94	< 20%
	277 Vac	28.0	.13		
	170 Vdc	27.2	.16	—	
	300 Vdc	27.2	.09		
	347 Vac	29.7	.10	> .93	
	480 Vac	29.8	.06		
MLLED3	120 Vac	38.0	.38	> .96	< 20%
	277 Vac	38.0	.16		
	170 Vdc	37.4	.22	—	
	300 Vdc	39.0	.13		
	347 Vac	39.6	.13	> .96	
	480 Vac	39.7	.08		
MLLED4	120 Vac	48.0	.48	> .97	< 20%
	277 Vac	48.0	.20		
	170 Vdc	49.3	.29	—	
	300 Vdc	48.0	.16		
	347 Vac	50.5	.16	> .97	
	480 Vac	50.4	.10		

① All values are typical (tolerance +/-10%).

† Use of fuse voids Marine Outside Type (Salt Water) rating.

Mercmaster™ LED Low Profile Luminaires

Enclosed and Gasketed Fixtures

NEC/CEC:
 Class I, Division 2, Groups A,B,C,D
 Class I, Zone 2, AEx ec IIC
 Zone 21, AEx tb IIIC
 Class I, Zone 2 Ex ec II
 Class II, Division 1, Groups E,F,G
 Zone 20, Group IIIC
 Class II, Division 2, Groups F,G
 Class III

NEC/CEC:
 Type 3R, 4, 4X
 IP66/IP67
 Simultaneous Exposure
 Suitable for Use in Wet Locations
 Marine Outside Type (Salt Water) For USA ONLY ⚠
 American Bureau of Shipping (ABS) Certified
 International Dark Sky (IDA) Approved

ATEX:
 Zone 2 and 21-22
 II 2 D
 II 3 GD
 IP66
 IK08

IECEX:
 Zone 2 and 21-22
 Ex ec IIC
 Ex op is tb IIIC
 Ex tc IIIC
 IP66
 IK08









Fixture Unit — Ballast Body and Globe or Refractor



Fixture Housing - For Hazardous Locations

Catalog Number ①							
Lumen Level	LED Wattage	Light Level Equivalent	NEMA Type	Polycarbonate Globe ①②③	Polycarbonate Diffused Globe ①②③	Glass Globe ①②③④	With Type V Glass Refractor ①②③④
3K	28	70-100W HPS	Type V	MLLED2XP5	MLLED2XD5	MLLED2XG5	MLLED2XJ5
4K	38	100-150W HPS	Type V	MLLED3XP5	MLLED3XD5	MLLED3XG5	MLLED3XJ5
5K	48	150-175W HPS	Type V	MLLED4XP5	MLLED4XD5	MLLED4XG5	MLLED4XJ5

Mounting Hoods

	Description	Hub Size	Catalog Number
	One Hub	3/4	KPA-75
		1	KPA-100
		M20	KPA-M20
	One Hub	3/4	KPA-75-WT
		1	KPA-100-WT
	One Hub, Rigid Mounting	3/4	KPCH-75
		1	KPCH-100
		M20	KPCH-M20
	One Hub	3/4	KPCT-75
		1	KPCT-100
	Five Hubs, Four Close-Up Plugs	3/4	KPC-75
		1	KPC-100
		M20	KPC-M20
	Five Hubs, Four Close-Up Plugs	3/4	KPWB-75
		1	KPWB-100
		M20	KPWB-M20
	One Hub	1-1/4	KPS-125
		1-1/2	KPS-150
	One Hub	1-1/4	KPST-125
		1-1/2	KPST-150

① For 120-277 VAC, use suffix **-BU**. For 347-480 VAC, use suffix **-BH**.

② For optional fusing, add suffix **-F** to the end of the catalog number. Factory installed.

③ **X** = Color temperature; **C** = Cool, 5000K CCT, **N** = Neutral, 4000K CCT, **W** = Warm, 3000K CCT. Example: **MLLED2CP5**.

④ Guards are available for fixtures with glass globe or refractor. See following pages for accessory ordering information.

⑤ Must be ordered separately.

⚠ Use of fuse voids Marine Outside Type (Salt Water) rating

Mercmaster™ LED Low Profile Luminaires

Enclosed and Gasketed Fixtures

NEC/CEC:
 Class I, Division 2, Groups A,B,C,D
 Class I, Zone 2, AEx ec IIC
 Zone 21, AEx tb IIIC
 Class I, Zone 2 Ex ec II
 Class II, Division 1, Groups E,F,G
 Zone 20, Group IIIC
 Class II, Division 2, Groups F,G
 Class III

NEC/CEC:
 Type 3R, 4, 4X
 IP66/IP67
 Simultaneous Exposure
 Suitable for Use in Wet Locations
 Marine Outside Type (Salt Water) For USA ONLY ⌘
 American Bureau of Shipping (ABS) Certified
 International Dark Sky (IDA) Approved

ATEX:
 Zone 2 and 21-22
 II 2 D
 II 3 GD
 IP66
 IK08

IECEX:
 Zone 2 and 21-22
 Ex ec IIC
 Ex op is tb IIIC
 Ex tc IIIC
 IP66
 IK08

Replacement Parts

	Description	Catalog Number
--	-------------	----------------

Globes and Gaskets



Clear Globe (polycarbonate)

VPGL-LED



Diffused Globe (polycarbonate)

VPGL-DIFF



Glass Globe

VPGL-GLASS

Light Distribution

Catalog Number

Closed Prismatic Glass Refractors – All Heat-Resistant



Glass Refractor ①

NEMA Type V

LPG-R5

Accessories

	Description	Catalog Number
--	-------------	----------------

White Polyester Reflectors



30° Angle

30° Angle

CMR-4AN

Guards



Glass Globe Guard



Refractor Guard

Glass Globe Guard

MGU1

Refractor Guard

KRG2

Safety Cable



Stainless steel

LEDSC

Visor



Electrostatically applied gray epoxy powder coat finish on Aluminum Visor

MMVISOR

Mounting Hood Adapters

	Manufacturer	Installed Mounting Hood	Appleton Adapter Catalog Number
--	--------------	-------------------------	---------------------------------



Crouse-Hinds™
Champ®

APM2/3 - Pendant
 CM2/3 - Ceiling
 HPM2 - Flexible Pendant

MMADCHVS



Appleton™
Mercmaster™ II

LPA75/100 - Pendant
 LPC75/100 - Ceiling

MMADIIS



Crouse-Hinds™
Champ®

TWM2/3 - Wall
 JM5 - 25° Angle Stanchion
 PM5 - 90° Straight Stanchion

MMADCHVA



Appleton™
Mercmaster™ II

LPWB75, LPWB100 - Wall
 LPS125, LPS150 - 25° Angle Stanchion
 VMX2B, VMX3B, VMX6B, VMX7B, VMX9B - Ceiling

MMADIIA



Killark™

VMA2B, VMA3B - Pendant
 VMD4B, VMD5B, VMS4B, VMS5B - Stanchion
 VMB2B, VMB3B - Wall
 VMC2B, VMC3B - Pendant Cone

MMADKVA

① NEMA Type V refractor only permitted for cCSAus rating.

⌘ Use of fuse voids Marine Outside Type (Salt Water) rating.

Mercmaster™ LED Low Profile Luminaires

Enclosed and Gasketed Fixtures

NEC/CEC:
 Class I, Division 2, Groups A,B,C,D
 Class I, Zone 2, AEx ec IIC
 Zone 21, AEx tb IIIC
 Class I, Zone 2 Ex ec II
 Class II, Division 1, Groups E,F,G
 Zone 20, Group IIIC
 Class II, Division 2, Groups F,G
 Class III

NEC/CEC:
 Type 3R, 4, 4X
 IP66/IP67
 Simultaneous Exposure
 Suitable for Use in Wet Locations
 Marine Outside Type (Salt Water) For USA ONLY ⌘
 American Bureau of Shipping (ABS) Certified
 International Dark Sky (IDA) Approved

ATEX:
 Zone 2 and 21-22
 II 2 D
 II 3 GD
 IP66
 IK08

IECEX:
 Zone 2 and 21-22
 Ex ec IIC
 Ex op is tb IIIC
 Ex tc IIIC
 IP66
 IK08

PCD2 Series Factory Sealed Hazardous Location Photocontrol ①

	Voltage Range	Max VA	Max Current Amps	Suffix Designation	Catalog Number
--	---------------	--------	------------------	--------------------	----------------

Factory Installed Photocontrol – Not for ceiling or pendant cone Add to fixture catalog after voltage; i.e.: MLLEDA32XP5BU1. ②

	120 V, 50/60 Hz	1000	8.3 Amp		1
	208 V, 50/60 Hz	1000	4.8 Amp		2
	240 V, 50/60 Hz	1000	4.2 Amp		3
	277 V, 50/60 Hz	1000	3.6 Amp		4

Photocontrol in FS Cover for Use with FS/FD Box Supplied with two stainless steel screws. For neoprene gasket, order catalog number FS-GKR-1N.



	120 V, 50/60 Hz	1000	8.3 Amp	FSKA-PC120D2
	208 V, 50/60 Hz	1000	4.8 Amp	
	240 V, 50/60 Hz	1000	4.2 Amp	FSKA-PC247D2
	277 V, 50/60 Hz	1000	3.6 Amp	

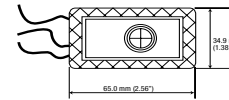
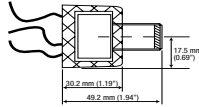
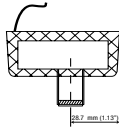

Photocontrol Top Hats

Mounting Hood	Hub Size	Photocontrol Option	Catalog Number
Pendant	3/4" NPT	120V	KPA75PC12D2
Pendant	3/4" NPT	208V, 240V, 277V	KPA75PC24D2
Pendant	1" NPT	120V	KPA100PC12D2
Pendant	1" NPT	208V, 240V, 277V	KPA100PC24D2
Wall	3/4" NPT	120V	KPWB75PC12D2
Wall	3/4" NPT	208V, 240V, 277V	KPWB75PC24D2
Wall	1" NPT	120V	KPWB100PC12D2
Wall	1" NPT	208V, 240V, 277V	KPWB100PC24D2
25 Stanchion	1-1/4" NPT stanchion	120V	KPS125PC12D2
25 Stanchion	1-1/4" NPT stanchion	208V, 240V, 277V	KPS125PC24D2
25 Stanchion	1-1/2" NPT stanchion	120V	KPS150PC12D2
25 Stanchion	1-1/2" NPT stanchion	208V, 240V, 277V	KPS150PC24D2
90 Stanchion	1-1/4" NPT stanchion	120V	KPST125PC12D2
90 Stanchion	1-1/4" NPT stanchion	208V, 240V, 277V	KPST125PC24D2
90 Stanchion	1-1/2" NPT stanchion	120V	KPST150PC12D2
90 Stanchion	1-1/2" NPT stanchion	208V, 240V, 277V	KPST150PC24D2

Replacement Drivers

	Voltage ③	Driver Wattage	Luminaire Model	Constant Current Settings	Catalog Number
	BU	50 Watt	MLLED2	720mA	APMS050C135UD72
	BH			720mA	APMS050C135HD72
	BU	50 Watt	MLLED3	1000mA	APMS050C135UD10
	BH			1000mA	APMS050C135HD10
	BU	50 Watt	MLLED4	1300mA	APMS050C135UD13
	BH			1300mA	APMS050C135HD13

① Fixtures with photocontrols are not rated IP66/67, Type 4X, marine outside type (salt water), or Class II. Available for 120-277 VAC versions only.

② X = Color temperature; C = Cool, 5000K CCT, N = Neutral, 4000K CCT, W = Warm, 3000K CCT

③ BH voltage only permitted for cCSAus rating.

⌘ Use of fuse voids Marine Outside Type (Salt Water) rating.

Mercmaster™ LED Low Profile Luminaires

Enclosed and Gasketed Fixtures

NEC/CEC:
 Class I, Division 2, Groups A,B,C,D
 Class I, Zone 2, AEx ec IIC
 Zone 21, AEx tb IIIC
 Class I, Zone 2 Ex ec II
 Class II, Division 1, Groups E,F,G
 Zone 20, Group IIIC
 Class II, Division 2, Groups F,G
 Class III

NEC/CEC:
 Type 3R, 4, 4X
 IP66/IP67
 Simultaneous Exposure
 Suitable for Use in Wet Locations
 Marine Outside Type (Salt Water) For USA ONLY ⚠
 American Bureau of Shipping (ABS) Certified
 International Dark Sky (IDA) Approved

ATEX:
 Zone 2 and 21-22
 II 2 D
 II 3 GD
 IP66
 IK08

IECEX:
 Zone 2 and 21-22
 Ex ec IIC
 Ex op is tb IIIC
 Ex tc IIIC
 IP66
 IK08

Dimensions in Millimeters (Inches)

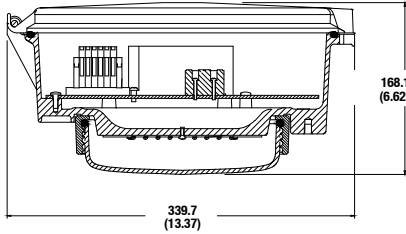

Pendant Mount

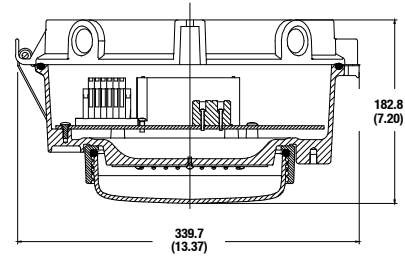

Ceiling Mount

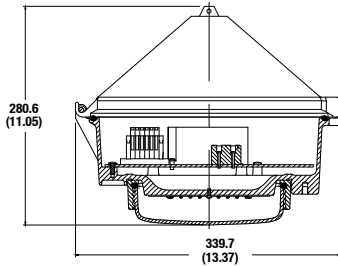

Pendant Cone Mount

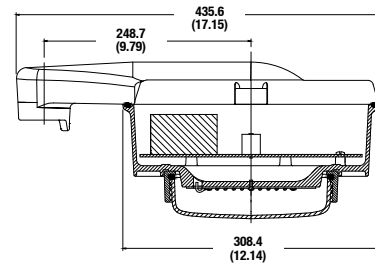

90° Stanchion Mount

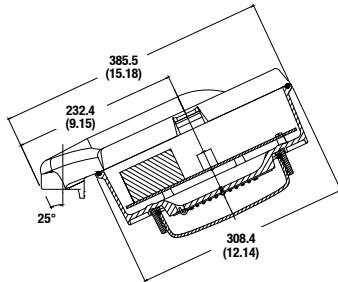

25° Stanchion Mount

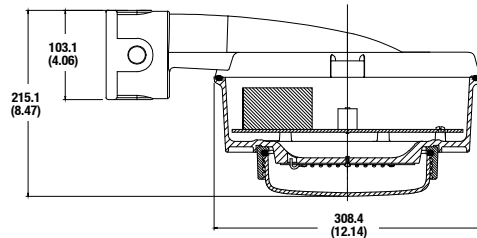

Wall Mount

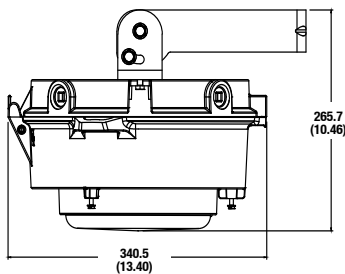

Trunnion Mount

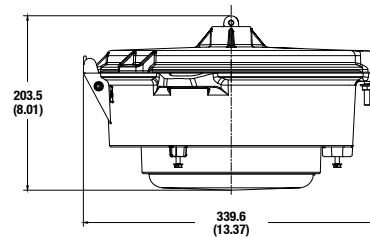

Watertight Pendant Mount

⚠ Use of fuse voids Marine Outside Type (Salt Water) rating.

Mercmaster™ LED Low Profile Luminaires

Enclosed and Gasketed Fixtures

NEC/CEC:
 Class I, Division 2, Groups A,B,C,D
 Class I, Zone 2, AEx ec IIC
 Zone 21, AEx tb IIIC
 Class I, Zone 2 Ex ec II
 Class II, Division 1, Groups E,F,G
 Zone 20, Group III C
 Class II, Division 2, Groups F,G
 Class III

NEC/CEC:
 Type 3R, 4, 4X
 IP66/IP67
 Simultaneous Exposure
 Suitable for Use in Wet Locations
 Marine Outside Type (Salt Water) For USA ONLY ⚠
 American Bureau of Shipping (ABS) Certified
 International Dark Sky (IDA) Approved

ATEX:
 Zone 2 and 21-22
 II 2 D
 II 3 GD
 IP66
 IK08

IECEX:
 Zone 2 and 21-22
 Ex ec IIC
 Ex op is tb IIIC
 Ex tc IIIC
 IP66
 IK08

Dimensions in Millimeters (Inches)

With Polycarbonate Globe

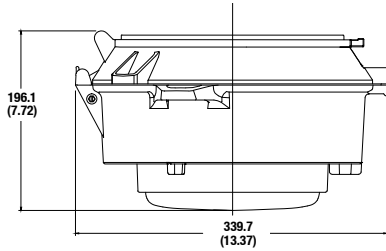

CH-Adapter-Centric

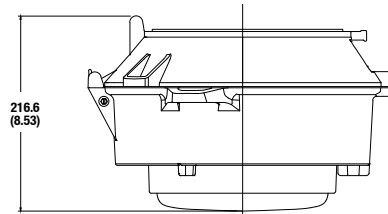

MM-II Adapter-Centric

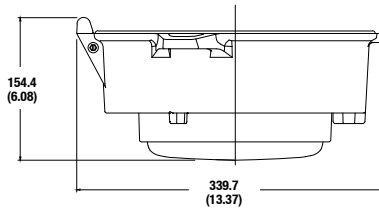

Driver Housing

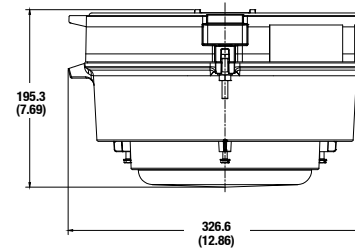

Killark-Adapter-Centric

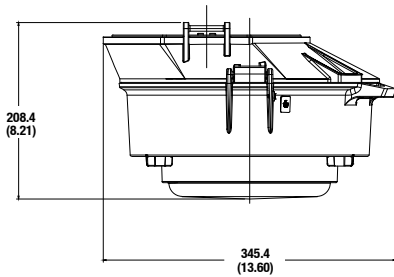

CH-Adapter Off-Centric

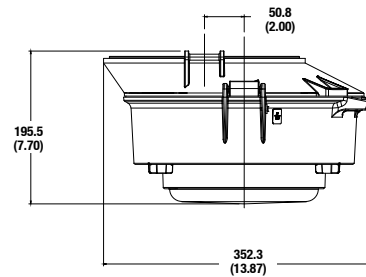

MM-II Adapter Off Centric

Mercmaster™ LED Low Profile Fixture and Mounting Hood Weights

Description	Weight kg (lb)
Fixture Unit	4.6 (10.10)
Pendant Mounting Hood	1.0 (2.25)
Pendant Cone Mounting Hood	1.1 (2.50)
Ceiling Mounting Hood	1.4 (3.00)
Wall Mounting Hood	1.8 (4.00)
25° Stanchion Mounting Hood	1.5 (3.25)
90° Stanchion Mounting Hood	1.7 (3.75)
MM-II Adapter-Centric	0.9 (2.00)
MM-II Adapter-Off-Centric	0.9 (2.00)
CH-Adapter-Centric	0.9 (2.00)
CH-Adapter-Off-Centric	0.9 (2.00)
Killark-Adapter-Centric	1.0 (2.3)

⚠ Use of fuse voids Marine Outside Type (Salt Water) rating.

Mercmaster™ LED Low Profile Luminaires

Enclosed and Gasketed Fixtures

NEC/CEC:
 Class I, Division 2, Groups A,B,C,D
 Class I, Zone 2, AEx ec IIC
 Zone 21, AEx tb IIIC
 Class I, Zone 2 Ex ec II
 Class II, Division 1, Groups E,F,G
 Zone 20, Group IIIC
 Class II, Division 2, Groups F,G
 Class III

NEC/CEC:
 Type 3R, 4, 4X
 IP66/IP67
 Simultaneous Exposure
 Suitable for Use in Wet Locations
 Marine Outside Type (Salt Water) For USA ONLY ⌘
 American Bureau of Shipping (ABS) Certified
 International Dark Sky (IDA) Approved

ATEX:
 Zone 2 and 21-22
 II 2 D
 II 3 GD
 IP66
 IK08

IECEX:
 Zone 2 and 21-22
 Ex ec IIC
 Ex op is tb IIIC
 Ex tc IIIC
 IP66
 IK08

Photometric Data – DATA SHOWN IS ABSOLUTE

Type V, Clear Polycarbonate 5000K CCT

REPORT NUMBER: MLLED2CP5BU

Luminaire Lumens 3,198

POLAR CANDELA DISTRIBUTION

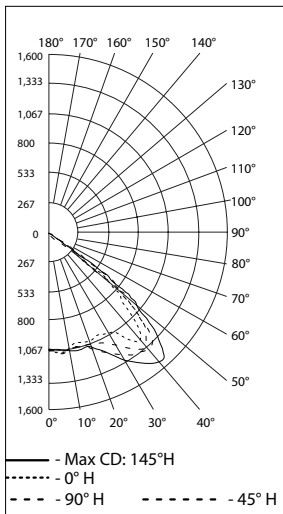

ISOFOOT CANDLE PLOT

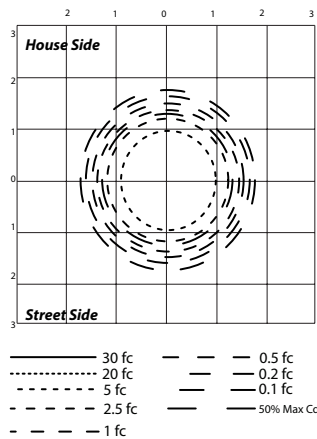

ZONAL LUMEN SUMMARY

Zone	Lumens	% Luminaire
0-30	932.7	29.2%
0-40	1,750.7	54.7%
0-60	3,144.3	98.3%
60-90	48.0	1.5%
70-100	17.6	0.6%
90-120	4.8	0.2%
0-90	3,192.3	99.8%
90-180	5.7	0.2%
0-180	3,198.0	100%

LUMENS PER ZONE

Zone	Lumens	% Total	Zone	Lumens	% Total
0-10	102.0	3.2%	90-100	1.9	0.1%
10-20	302.3	9.5%	100-110	1.9	0.1%
20-30	528.5	16.5%	110-120	1.0	0%
30-40	817.9	25.6%	120-130	0.8	0%
40-50	969.4	30.3%	130-140	0.0	0%
50-60	424.2	13.3%	140-150	0	0%
60-70	32.3	1.0%	150-160	0.0	0%
70-80	10.3	0.3%	160-170	0.0	0%
80-90	5.4	0.2%	170-180	0.0	0%

Type V, Clear Polycarbonate 5000K CCT

REPORT NUMBER: MLLED2CD5BU

Luminaire Lumens 3,103

POLAR CANDELA DISTRIBUTION

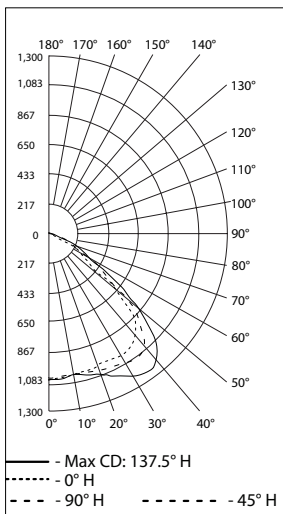

ISOFOOT CANDLE PLOT

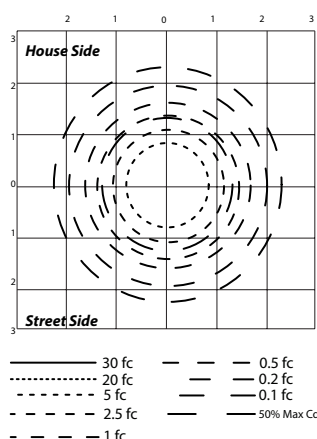

ZONAL LUMEN SUMMARY

Zone	Lumens	% Luminaire
0-30	903.1	29.1%
0-40	1,609.3	51.9%
0-60	2,795.0	90.1%
60-90	283.4	9.1%
70-100	107.9	3.5%
90-120	24.0	0.8%
0-90	3,078.4	99.2%
90-180	25.3	0.8%
0-180	3,103.7	100%

LUMENS PER ZONE

Zone	Lumens	% Total	Zone	Lumens	% Total
0-10	100.3	3.2%	90-100	9.0	0.3%
10-20	298.2	9.6%	100-110	10.7	0.3%
20-30	504.6	16.3%	110-120	4.3	0.1%
30-40	706.2	22.8%	120-130	1.2	0%
40-50	735.2	23.7%	130-140	0.1	0%
50-60	450.5	14.5%	140-150	0	0%
60-70	184.5	5.9%	150-160	0	0%
70-80	75.4	2.4%	160-170	0	0%
80-90	23.5	0.8%	170-180	0	0%

⌘ Use of fuse voids Marine Outside Type (Salt Water) rating.

Mercmaster™ LED Low Profile Luminaires

Enclosed and Gasketed Fixtures

NEC/CEC:
 Class I, Division 2, Groups A,B,C,D
 Class I, Zone 2, AEx ec IIC
 Zone 21, AEx tb IIIC
 Class I, Zone 2 Ex ec II
 Class II, Division 1, Groups E,F,G
 Zone 20, Group IIIC
 Class II, Division 2, Groups F,G
 Class III

NEC/CEC:
 Type 3R, 4, 4X
 IP66/IP67
 Simultaneous Exposure
 Suitable for Use in Wet Locations
 Marine Outside Type (Salt Water) For USA ONLY ⚠
 American Bureau of Shipping (ABS) Certified
 International Dark Sky (IDA) Approved

ATEX:
 Zone 2 and 21-22
 II 2 D
 II 3 GD
 IP66
 IK08

IECEX:
 Zone 2 and 21-22
 Ex ec IIC
 Ex op is tb IIIC
 Ex tc IIIC
 IP66
 IK08

Photometric Data — DATA SHOWN IS ABSOLUTE

Type V, Clear Polycarbonate 5000K CCT

REPORT NUMBER: MLLED2CG5BU

Luminaire Lumens 3,334

POLAR CANDELA DISTRIBUTION

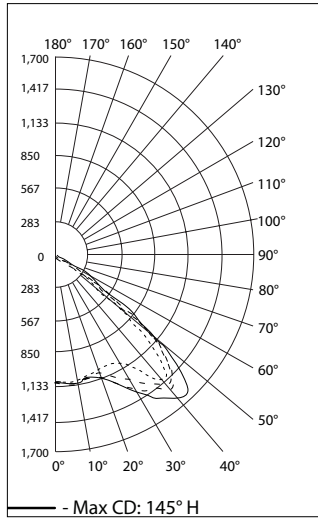

ISOFOOT CANDLE PLOT

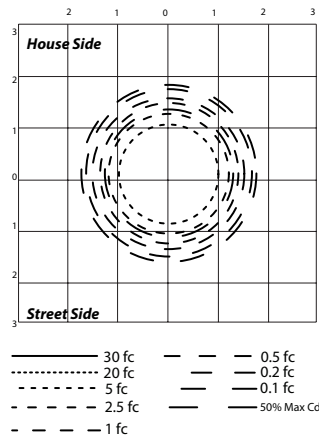

ZONAL LUMEN SUMMARY

Zone	Lumens	% Luminaire
0-30	960.0	28.8%
0-40	1,828.8	54.8%
0-60	3,298.1	98.9%
60-90	32.1	1%
70-100	8.4	0.3%
90-120	3.9	0.1%
0-90	3,330.2	99.9%
90-180	4.2	0.1%
0-180	3,334.5	100%

LUMENS PER ZONE

Zone	Lumens	% Total	Zone	Lumens	% Total
0-10	105.6	3.2%	90-100	1.1	0%
10-20	309.3	9.3%	100-110	1.2	0%
20-30	545.0	16.3%	110-120	1.6	0%
30-40	868.8	26.1%	120-130	0.3	0%
40-50	1,049.7	31.5%	130-140	0.0	0%
50-60	419.6	12.6%	140-150	0.1	0%
60-70	24.8	0.7%	150-160	0	0%
70-80	4.9	0.1%	160-170	0	0%
80-90	2.4	0.1%	170-180	0	0%

Type V, Clear Polycarbonate 5000K CCT

REPORT NUMBER: MLLED2CJ5BU

Luminaire Lumens 3,020

POLAR CANDELA DISTRIBUTION

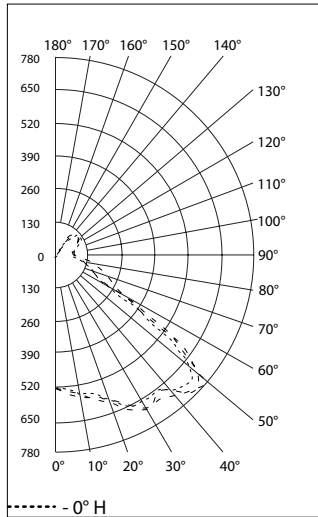

ISOFOOT CANDLE PLOT

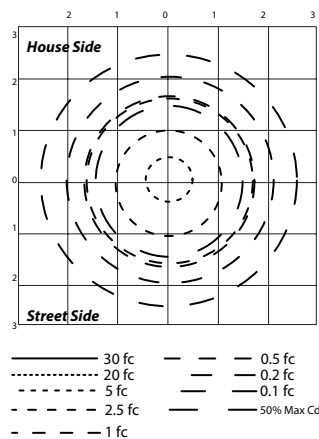

ZONAL LUMEN SUMMARY

Zone	Lumens	% Luminaire
0-30	526.8	17.4%
0-40	959.4	31.8%
0-60	2,035.0	67.4%
60-90	516.7	17.1%
70-100	363.7	12%
90-120	231.1	7.6%
0-90	2,551.7	84.5%
90-180	468.9	15.5%
0-180	3,020.6	100%

LUMENS PER ZONE

Zone	Lumens	% Total	Zone	Lumens	% Total
0-10	52.5	1.7%	90-100	81.0	2.7%
10-20	167.2	5.5%	100-110	70.8	2.3%
20-30	307.0	10.2%	110-120	79.3	2.6%
30-40	432.6	14.3%	120-130	104.8	3.5%
40-50	573.9	19.0%	130-140	90.3	3%
50-60	501.7	16.6%	140-150	37.8	1.3%
60-70	234.1	7.7%	150-160	4.9	0.2%
70-80	167.4	5.5%	160-170	0.0	0%
80-90	115.3	3.8%	170-180	0	0%

⚠ Use of fuse voids Marine Outside Type (Salt Water) rating.

Mercmaster™ LED Low Profile Luminaires

Enclosed and Gasketed Fixtures

NEC/CEC:
 Class I, Division 2, Groups A,B,C,D
 Class I, Zone 2, AEx ec IIC
 Zone 21, AEx tb IIIC
 Class I, Zone 2 Ex ec II
 Class II, Division 1, Groups E,F,G
 Zone 20, Group IIIC
 Class II, Division 2, Groups F,G
 Class III

NEC/CEC:
 Type 3R, 4, 4X
 IP66/IP67
 Simultaneous Exposure
 Suitable for Use in Wet Locations
 Marine Outside Type (Salt Water) For USA ONLY ⚠
 American Bureau of Shipping (ABS) Certified
 International Dark Sky (IDA) Approved

ATEX:
 Zone 2 and 21-22
 II 2 D
 II 3 GD
 IP66
 IK08

IECEX:
 Zone 2 and 21-22
 Ex ec IIC
 Ex op is tb IIIC
 Ex tc IIIC
 IP66
 IK08

Photometric Data – DATA SHOWN IS ABSOLUTE

Type V, Clear Polycarbonate 5000K CCT

REPORT NUMBER: **MLLED3CP5BU**

Luminaire Lumens 4,234

POLAR CANDELA DISTRIBUTION

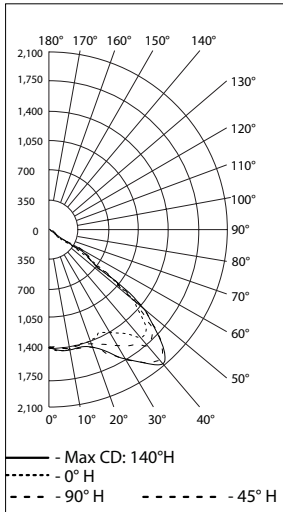

ISOFOOT CANDLE PLOT

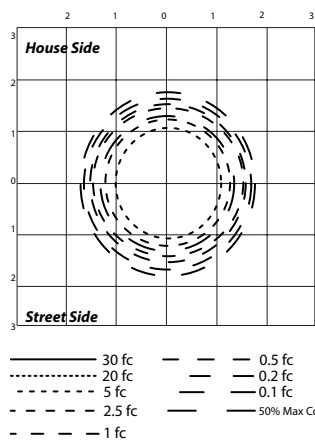

ZONAL LUMEN SUMMARY

Zone	Lumens	% Luminaire
0-30	1,229.4	29%
0-40	2,320.7	54.8%
0-60	4,178.7	98.7%
60-90	49.5	1.2%
70-100	18.7	0.4%
90-120	5.2	0.1%
0-90	4,228.2	99.9%
90-180	6.0	0.1%
0-180	4,234.3	100%

LUMENS PER ZONE

Zone	Lumens	% Total	Zone	Lumens	% Total
0-10	134.1	3.2%	90-100	2.3	0.1%
10-20	396.8	9.4%	100-110	1.9	0%
20-30	698.5	16.5%	110-120	1.0	0%
30-40	1,091.3	25.8%	120-130	0.8	0%
40-50	1,302.8	30.8%	130-140	0.0	0%
50-60	555.3	13.1%	140-150	0.0	0%
60-70	33.0	0.8%	150-160	0.0	0%
70-80	10.5	0.2%	160-170	0.0	0%
80-90	5.9	0.1%	170-180	0.0	0%

Type V, Clear Polycarbonate 5000K CCT

REPORT NUMBER: **MLLED3CD5BU**

Luminaire Lumens 4,151

POLAR CANDELA DISTRIBUTION

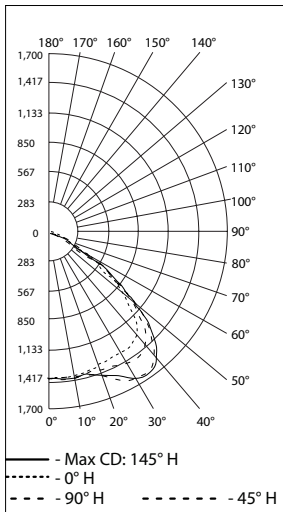

ISOFOOT CANDLE PLOT

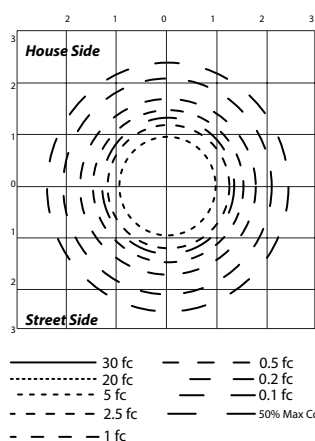

ZONAL LUMEN SUMMARY

Zone	Lumens	% Luminaire
0-30	1,206.1	29.1%
0-40	2,153.6	51.9%
0-60	3,742.1	90.2%
60-90	375.5	9%
70-100	142.2	3.4%
90-120	31.3	0.8%
0-90	4,117.6	99.2%
90-180	33.1	0.8%
0-180	4,150.7	100%

LUMENS PER ZONE

Zone	Lumens	% Total	Zone	Lumens	% Total
0-10	133.5	3.2%	90-100	11.7	0.3%
10-20	397.0	9.6%	100-110	14.0	0.3%
20-30	675.6	16.3%	110-120	5.5	0.1%
30-40	947.5	22.8%	120-130	1.6	0%
40-50	986.1	23.8%	130-140	0.1	0%
50-60	602.4	14.5%	140-150	0.1	0%
60-70	245.0	5.9%	150-160	0.0	0%
70-80	99.5	2.4%	160-170	0.0	0%
80-90	30.9	0.7%	170-180	0.0	0%

⚠ Use of fuse voids Marine Outside Type (Salt Water) rating.

Mercmaster™ LED Low Profile Luminaires

Enclosed and Gasketed Fixtures

NEC/CEC:
 Class I, Division 2, Groups A,B,C,D
 Class I, Zone 2, AEx ec IIC
 Zone 21, AEx tb IIIC
 Class I, Zone 2 Ex ec II
 Class II, Division 1, Groups E,F,G
 Zone 20, Group IIIC
 Class II, Division 2, Groups F,G
 Class III

NEC/CEC:
 Type 3R, 4, 4X
 IP66/IP67
 Simultaneous Exposure
 Suitable for Use in Wet Locations
 Marine Outside Type (Salt Water) For USA ONLY ⌘
 American Bureau of Shipping (ABS) Certified
 International Dark Sky (IDA) Approved

ATEX:
 Zone 2 and 21-22
 II 2 D
 II 3 GD
 IP66
 IK08

IECEX:
 Zone 2 and 21-22
 Ex ec IIC
 Ex op is tb IIIC
 Ex tc IIIC
 IP66
 IK08

Photometric Data – DATA SHOWN IS ABSOLUTE

Type V, Clear Polycarbonate 5000K CCT

REPORT NUMBER: MLLED3CG5BU

Luminaire Lumens 4,468

POLAR CANDELA DISTRIBUTION

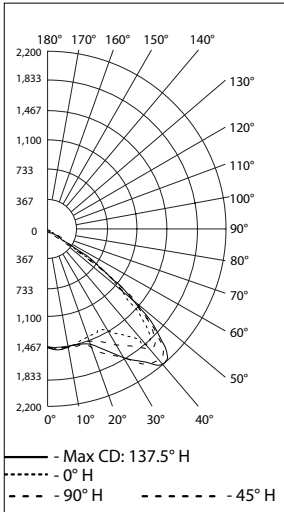

ISOFOOT CANDLE PLOT

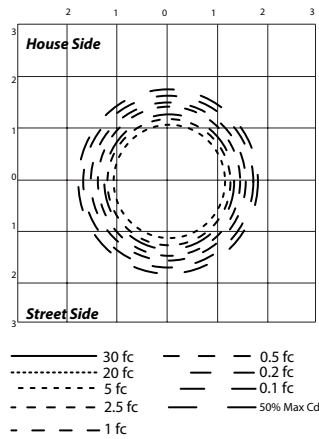

ZONAL LUMEN SUMMARY

Zone	Lumens	% Luminaire
0-30	1,282.8	28.7%
0-40	2,447.8	54.8%
0-60	4,419.1	98.9%
60-90	42.9	1%
70-100	11.0	0.2%
90-120	4.8	0.1%
0-90	4,461.9	99.9%
90-180	6.1	0.1%
0-180	4,468.0	100%

LUMENS PER ZONE

Zone	Lumens	% Total	Zone	Lumens	% Total
0-10	140.3	3.1%	90-100	1.2	0%
10-20	411.6	9.2%	100-110	1.4	0%
20-30	730.9	16.4%	110-120	2.1	0%
30-40	1,164.9	26.1%	120-130	0.6	0%
40-50	1,407.0	31.5%	130-140	0.1	0%
50-60	564.3	12.6%	140-150	0.4	0%
60-70	33.0	0.7%	150-160	0.2	0%
70-80	6.5	0.1%	160-170	0.1	0%
80-90	3.3	0.1%	170-180	0.0	0%

Type V, Clear Polycarbonate 5000K CCT

REPORT NUMBER: MLLED3CJ5BU

Luminaire Lumens 4,020

POLAR CANDELA DISTRIBUTION

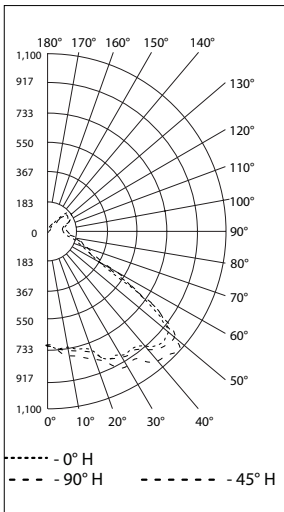

ISOFOOT CANDLE PLOT

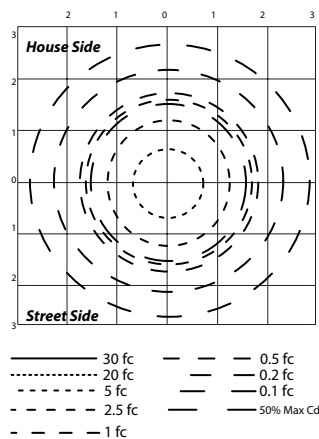

ZONAL LUMEN SUMMARY

Zone	Lumens	% Luminaire
0-30	699.2	17.4%
0-40	1,275.6	31.7%
0-60	2,714.3	67.5%
60-90	689.0	17.1%
70-100	484.7	12.1%
90-120	307.5	7.6%
0-90	3,403.3	84.6%
90-180	617.3	15.4%
0-180	4,020.6	100%

LUMENS PER ZONE

Zone	Lumens	% Total	Zone	Lumens	% Total
0-10	70.0	1.7%	90-100	107.5	
10-20	222.3	5.5%	100-110	94.0	
20-30	406.9	10.1%	110-120	106.0	
30-40	576.4	14.3%	120-130	137.5	
40-50	768.1	19.1%	130-140	116.8	
50-60	670.6	16.7%	140-150	49.1	
60-70	311.8	7.8%	150-160	6.2	
70-80	223.5	5.6%	160-170	0.0	
80-90	153.7	3.8%	170-180	0	

⌘ Use of fuse voids Marine Outside Type (Salt Water) rating.

Mercmaster™ LED Low Profile Luminaires

Enclosed and Gasketed Fixtures

NEC/CEC:
 Class I, Division 2, Groups A,B,C,D
 Class I, Zone 2, AEx ec IIC
 Zone 21, AEx tb IIIC
 Class I, Zone 2 Ex ec II
 Class II, Division 1, Groups E,F,G
 Zone 20, Group IIIC
 Class II, Division 2, Groups F,G
 Class III

NEC/CEC:
 Type 3R, 4, 4X
 IP66/IP67
 Simultaneous Exposure
 Suitable for Use in Wet Locations
 Marine Outside Type (Salt Water) For USA ONLY ⌘
 American Bureau of Shipping (ABS) Certified
 International Dark Sky (IDA) Approved

ATEX:
 Zone 2 and 21-22
 II 2 D
 II 3 GD
 IP66
 IK08

IECEX:
 Zone 2 and 21-22
 Ex ec IIC
 Ex op is tb IIIC
 Ex tc IIIC
 IP66
 IK08

Photometric Data — DATA SHOWN IS ABSOLUTE

Type V, Clear Polycarbonate 5000K CCT

REPORT NUMBER: MLLED4CP5BU

Luminaire Lumens 5,330

POLAR CANDELA DISTRIBUTION

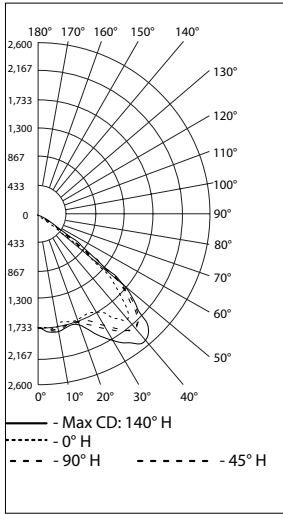

ISOFOOT CANDLE PLOT

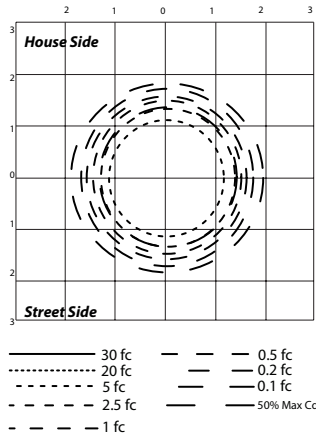

ZONAL LUMEN SUMMARY

Zone	Lumens	% Luminaire
0-30	1,525.8	28.6%
0-40	2,872.5	53.9%
0-60	5,237.4	98.3%
60-90	82.4	1.5%
70-100	29.4	0.6%
90-120	7.9	0.1%
0-90	5,319.8	99.8%
90-180	10.7	0.2%
0-180	5,330.5	100%

LUMENS PER ZONE

Zone	Lumens	% Total	Zone	Lumens	% Total
0-10	166.7	3.1%	90-100	3.1	0.1%
10-20	493.8	9.3%	100-110	3.0	0.1%
20-30	865.2	16.2%	110-120	1.7	0%
30-40	1,346.8	25.3%	120-130	0.9	0%
40-50	1,619.8	30.4%	130-140	0.6	0%
50-60	745.2	14.0%	140-150	0.6	0%
60-70	56.1	1.1%	150-160	0.4	0%
70-80	17.0	0.3%	160-170	0.2	0%
80-90	9.2	0.2%	170-180	0.1	0%

Type V, Clear Polycarbonate 5000K CCT

REPORT NUMBER: MLLED4CD5BU

Luminaire Lumens 5,150

POLAR CANDELA DISTRIBUTION

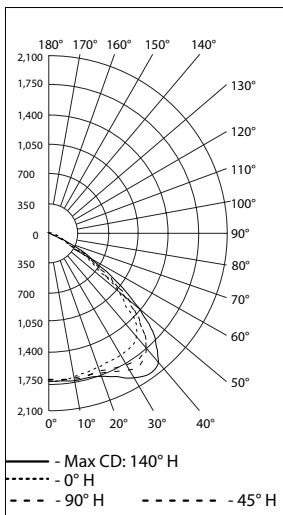

ISOFOOT CANDLE PLOT

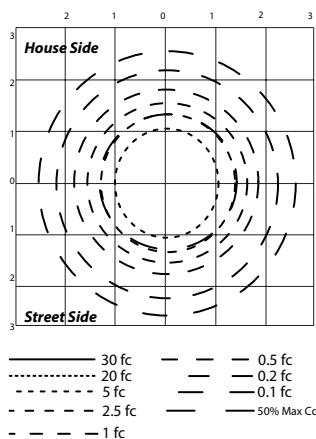

ZONAL LUMEN SUMMARY

Zone	Lumens	% Luminaire
0-30	1,484.5	28.8%
0-40	2,652.4	51.5%
0-60	4,632.4	89.9%
60-90	475.6	9.2%
70-100	180.0	3.5%
90-120	39.1	0.8%
0-90	5,108.0	99.2%
90-180	42.1	0.8%
0-180	5,150.1	100%

LUMENS PER ZONE

Zone	Lumens	% Total	Zone	Lumens	% Total
0-10	164.4	3.2%	90-100	14.5	0.3%
10-20	488.7	9.5%	100-110	17.8	0.3%
20-30	831.4	16.1%	110-120	6.9	0.1%
30-40	1,167.9	22.7%	120-130	2.0	0%
40-50	1,223.7	23.8%	130-140	0.3	0%
50-60	756.3	14.7%	140-150	0.2	0%
60-70	310.0	6.0%	150-160	0.2	0%
70-80	125.8	2.4%	160-170	0.1	0%
80-90	39.8	0.8%	170-180	0.1	0%

⌘ Use of fuse voids Marine Outside Type (Salt Water) rating.

Mercmaster™ LED Low Profile Luminaires

Enclosed and Gasketed Fixtures

NEC/CEC:
 Class I, Division 2, Groups A,B,C,D
 Class I, Zone 2, AEx ec IIC
 Zone 21, AEx tb IIIC
 Class I, Zone 2 Ex ec II
 Class II, Division 1, Groups E,F,G
 Zone 20, Group III C
 Class II, Division 2, Groups F,G
 Class III

NEC/CEC:
 Type 3R, 4, 4X
 IP66/IP67
 Simultaneous Exposure
 Suitable for Use in Wet Locations
 Marine Outside Type (Salt Water) For USA ONLY ⚠
 American Bureau of Shipping (ABS) Certified
 International Dark Sky (IDA) Approved

ATEX:
 Zone 2 and 21-22
 II 2 D
 II 3 GD
 IP66
 IK08

IECEX:
 Zone 2 and 21-22
 Ex ec IIC
 Ex op is tb IIIC
 Ex tc IIIC
 IP66
 IK08

Photometric Data — DATA SHOWN IS ABSOLUTE

Type V, Clear Polycarbonate 5000K CCT

REPORT NUMBER: MLLED4CG5BU

Luminaire Lumens 5,529

POLAR CANDELA DISTRIBUTION

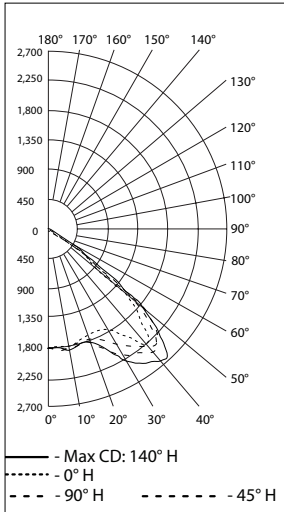

ISOFOOT CANDLE PLOT

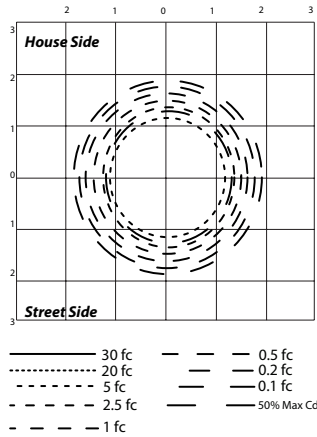

ZONAL LUMEN SUMMARY

Zone	Lumens	% Luminaire
0-30	1,575.5	28.5%
0-40	2,990.6	54.1%
0-60	5,434.7	98.3%
60-90	81.6	1.5%
70-100	27.7	0.5%
90-120	10.6	0.2%
0-90	5,516.3	99.8%
90-180	13.4	0.2%
0-180	5,529.7	100%

LUMENS PER ZONE

Zone	Lumens	% Total	Zone	Lumens	% Total
0-10	173.1	3.1%	90-100	3.8	0.1%
10-20	506.7	9.2%	100-110	3.3	0.1%
20-30	895.7	16.2%	110-120	3.5	0.1%
30-40	1,415.1	25.6%	120-130	1.3	0%
40-50	1,712.6	31.0%	130-140	0.5	0%
50-60	731.4	13.2%	140-150	0.4	0%
60-70	57.6	1.0%	150-160	0.4	0%
70-80	15.7	0.3%	160-170	0.2	0%
80-90	8.2	0.1%	170-180	0.1	0%

REPORT NUMBER: MLLED4CJ5BU

Luminaire Lumens 4,940

POLAR CANDELA DISTRIBUTION

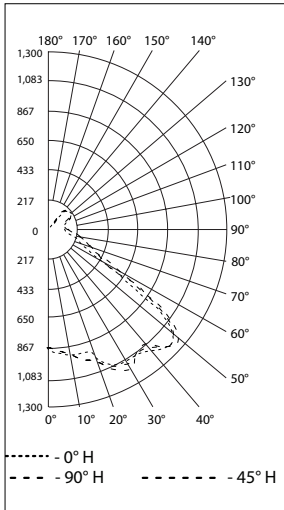

ISOFOOT CANDLE PLOT

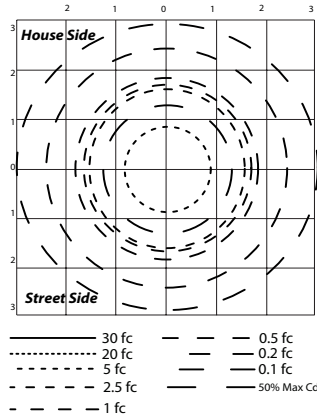

ZONAL LUMEN SUMMARY

Zone	Lumens	% Luminaire
0-30	872.9	17.7%
0-40	1,570.0	31.8%
0-60	3,310.7	67%
60-90	861.5	17.4%
70-100	606.8	12.3%
90-120	378.1	7.7%
0-90	4,172.1	84.4%
90-180	768.2	15.6%
0-180	4,940.4	100%

LUMENS PER ZONE

Zone	Lumens	% Total	Zone	Lumens	% Total
0-10	85.6	1.7%	90-100	134.2	2.7%
10-20	278.2	5.6%	100-110	116.1	2.3%
20-30	509.2	10.3%	110-120	127.8	2.6%
30-40	697.1	14.1%	120-130	169.8	3.4%
40-50	923.1	18.7%	130-140	148.5	3%
50-60	817.6	16.5%	140-150	63.2	1.3%
60-70	388.8	7.9%	150-160	8.4	0.2%
70-80	280.0	5.7%	160-170	0.1	0%
80-90	192.7	3.9%	170-180	0	0%

⚠ Use of fuse voids Marine Outside Type (Salt Water) rating.

Mercmaster™ LED Low Profile Luminaires with Emergency Battery Backup

Enclosed and Gasketed Fixtures

NEC/CEC:
 Class I, Division 2, Groups A,B,C,D
 Class I, Zone 2, Group IIC
 Class II, Division 1, Groups E,F,G
 Zone 21, Group IIC
 Class II, Division 2, Groups F,G
 Class III

NEC/GEC:
 Type 3R, 4, 4X
 IP66/IP67
 Simultaneous Exposure
 Suitable for Use in Wet Locations
 American Bureau of Shipping (ABS) Certified

Applications

- Enclosed and gasketed fixtures suitable for use in:
 - A wide range of industrial, chemical processing and other areas where flammable gases, vapors and combustible dusts are present including simultaneous exposure
 - Marine and wet locations
 - Areas of low clearance, low ceiling heights or where fixture weights must be minimized
- Typical applications include:
 - Walkways/catwalks
 - Stairwells
 - Grain elevators
 - Tunnels
 - Pipe racks
 - Offshore rigs
 - Vessel lighting
 - Cooling towers
 - Processing areas

Features

- Three light output levels for retrofit of HID fixtures up to 175 W.

Nominal Lumens ①	HID Equivalent	Model Number
3300	70-100W	MLLED2
4400	100-150W	MLLED3
5500	150-175W	MLLED4

Nominal lumen value for 5000K CCT, clear glass globe.
 Detailed lumen information is provided in tables.

- Choice of color temperature (CCT): 5000K cool white, 4000K neutral white or 3000K warm white.
- Seven standard mounting hood designs allow for mounting in any location. Uses same mounting hoods as Mercmaster™ III, Mercmaster™ Premium LED and Mercmaster™ LED Generation 3.
- Customize to the application requirements with three different field replaceable globe options: clear and diffused polycarbonate and clear glass.
- Provides up to 1400 lumens illumination for 90 minutes of emergency lighting with clear lens or 800 lumens illumination for 180 minutes of emergency lighting.
- Functional diagnostic test self-initiates every 14 days after initial start up.
- Duration test is automatically performed once per year.
- Green and Red LED lamps indicate charging status and provide fault warning.
- Simple quick disconnect connector disconnects power between LEDs and battery management module to allow maintenance in hazardous locations.
- Compact light weight low profile design is suited for low mounting heights.
- Hinge has high lip for added safety during installation and servicing. Hinge and bolt construction assures 360° compression at all points on fixture housing gasket for positive sealing. Swing away design of captive bolt and nut simplifies servicing.
- Standard 6 kV surge protection.



- Ambient Temperature: BU: -20 °C to +55 °C (-4 °F to +131 °F)
- Standard screw-type terminal block can accept UL/CSA 26-10 AWG wire.
- Heavy duty, high temperature silicone rubber gaskets.
- LED L70 rated at 109,000 Hours @ +25 °C (+77 °C).
- Field replaceable globes, battery management module (BMM), battery pack and LED driver.
- Rugged housing with superior thermal design translates to long luminaire life.
- Retrofit adapters for Crouse Hinds™ hood available. See Mercmaster CH Adapters.

Options

- Glass globe guard available, purchase separately.

Standard Materials

- Mounting hoods and bodies: cast copperfree (4/10 of 1% max.) aluminum
- All hardware and catch assemblies: stainless steel
- Globe: polycarbonate or glass
- Glass and polycarbonate globe guard: stainless steel wire
- Reflector: fiberglass reinforced white polyester

Standard Finishes

- Mounting hoods, bodies and glass refractor guard: gray epoxy powder coat finish, electrostatically applied for complete uniform protection

NEC/CEC Certifications and Compliances

- UL Standard: UL 50E, Second Edition; UL 844, Thirteenth Edition; UL 1598, Third Edition; UL 1598A, First Edition; UL 8750, Second Edition; UL 924, Tenth Edition
- CSA Standard: C22.2 No 0-10; C22.2 No. 94.2-15; C22.2 No. E60598-1-16; C22.2 No. 137-18; C22.2 No. 250.0-08; C22.2 No. 250.13-14 ; C22.2 No. 141-15
- ANSI/IEC Standard: 60529
- cCSAus Listed: Master contract 164460
- Ambient Temperature: 120-277 Volts: -20 °C up to +55 °C (-4 °F up to +131 °F)

Related Products

- Mercmaster LED Mounting Adapters
- Mercmaster LED Low Profile Luminaires

DesignLights™ Consortium

- Check DLC QPL for current list of products.

① Nominal Lumen value for 5000K CCT, clear glass globe. Detailed lumen information is provided in tables.

Mercmaster™ LED Low Profile Luminaires with Emergency Battery Backup

Enclosed and Gasketed Fixtures

NEC/CEC:
Class I, Division 2, Groups A,B,C,D
Class I, Zone 2, Group IIC
Class II, Division 1, Groups E,F,G
Zone 21, Group IIC
Class II, Division 2, Groups F,G
Class III

NEC/CEC:
Type 3R, 4, 4X
IP66/IP67
Simultaneous Exposure
Suitable for Use in Wet Locations
American Bureau of Shipping (ABS) Certified

Illustrated Features

Heatsink

Reliable heat transfer via the cast, epoxy powder coat aluminum body. Provides maximum heat dissipation from the LED assembly to the outside environment.

Reflectors and Visors

Reflectors are thick, tough fiberglass reinforced white polyester. Visor is aluminum with electrostatically applied, gray epoxy powder coat finish. Quickly attach either accessory to luminaire with furnished stainless steel screws.



Driver Assembly

Utilizing non-sparking components avoiding the ignition of gases or vapors that may be present. Field Replaceable Battery Management Module and Battery pack available.



Mounting Hood and Globe Gaskets

Silicone rubber gaskets seal out moisture, dirt and dust. Stays flexible, withstands extreme temperatures. Closure design assures uniform gasket compression.

Terminal Blocks

A seven-point terminal block is provided to facilitate wiring. Terminal block accommodates wire size ranging from 24-10 AWG.

Stainless Steel Latch Assembly

Captive, stainless steel latch assembly bolt and nut closes securely, resists attack of corrosive atmospheres. Swing-away design simplifies servicing.



Epoxy Finish

Fixture housing, hoods and guards are copperfree aluminum with triple protection epoxy powder coat finish.

Quick Disconnect

Simple quick disconnect connector disconnects power between LEDs and battery management module to allow maintenance in hazardous locations.

"Safety" Cable

Safety cable option threads through the fixture housing for additional safety.

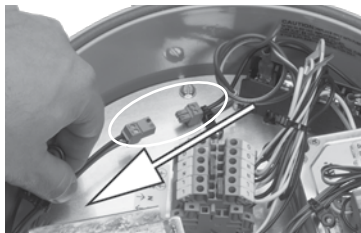

LED/AREA: NEC/CEC EMERGENCY

APPLETON™

Mercmaster™ LED Low Profile Luminaires with Emergency Battery Backup

Enclosed and Gasketed Fixtures

NEC/CEC:
 Class I, Division 2, Groups A,B,C,D
 Class I, Zone 2, Group IIC
 Class II, Division 1, Groups E,F,G
 Zone 21, Group IIIC
 Class II, Division 2, Groups F,G
 Class III

NEC/CEC:
 Type 3R, 4, 4X
 IP66/IP67
 Simultaneous Exposure
 Suitable for Use in Wet Locations
 American Bureau of Shipping (ABS) Certified

Mercmaster™ LED Low Profile Family Tree

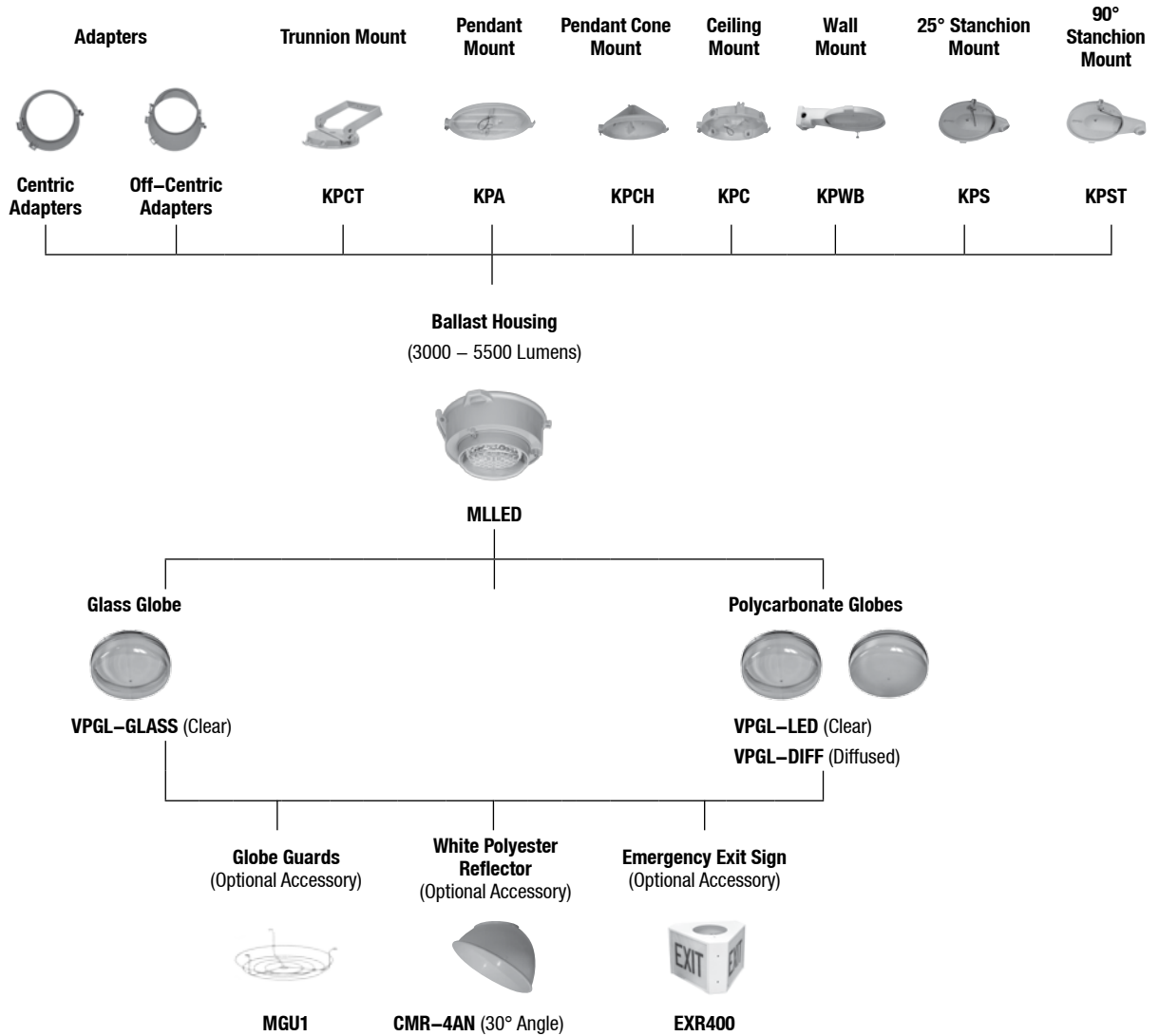

LED / AREA: NEC / CEC: EMERGENCY

APPLETON™

① Certified for cCSAus only.

Mercmaster™ LED Low Profile Luminaires with Emergency Battery Backup

Enclosed and Gasketed Fixtures

NEC/CEC:
 Class I, Division 2, Groups A,B,C,D
 Class I, Zone 2, Group IIC
 Class II, Division 1, Groups E,F,G
 Zone 21, Group IIIC
 Class II, Division 2, Groups F,G
 Class III

NEC/CEC:
 Type 3R, 4, 4X
 IP66/IP67
 Simultaneous Exposure
 Suitable for Use in Wet Locations
 American Bureau of Shipping (ABS) Certified

Order using catalog numbering guides below or select catalog number from tables on following pages.

Catalog Numbering Guide For Hazardous Locations:

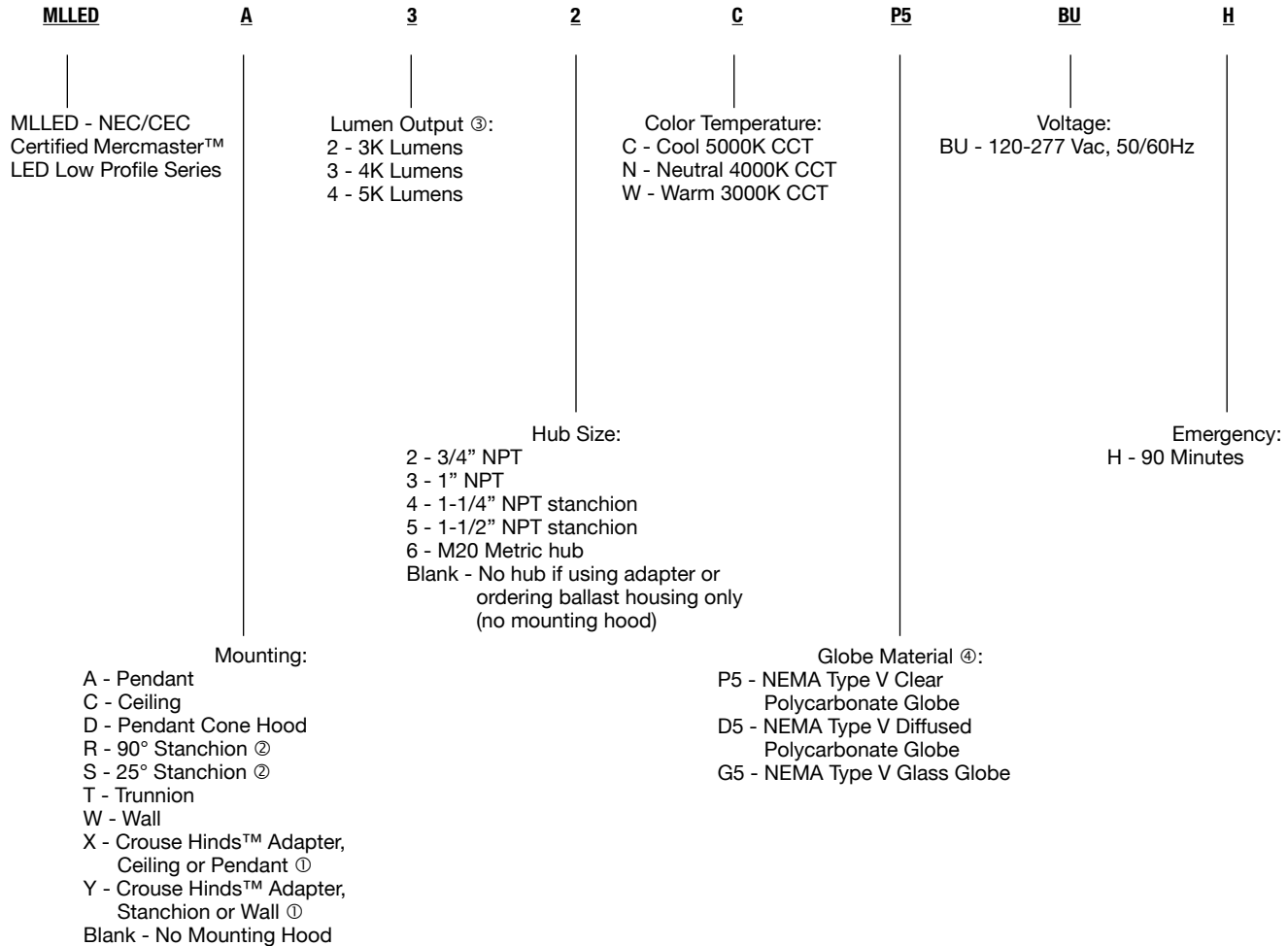

LED/AREA: NEC/CEC EMERGENCY

APPLETON™

① Certified for cCSAus only.
 ② 3/4" NPT, 1" NPT and Metric M20 hub entries not offered in this mounting option.
 ③ For specific lumen output information, see Lamp Comparison Chart.
 ④ Guards for the glass globes are ordered separately. See the Accessories for more information.

Mercmaster™ LED Low Profile Luminaires with Emergency Battery Backup

Enclosed and Gasketed Fixtures

NEC/CEC:
 Class I, Division 2, Groups A,B,C,D
 Class I, Zone 2, Group IIC
 Class II, Division 1, Groups E,F,G
 Zone 21, Group IIIC
 Class II, Division 2, Groups F,G
 Class III

NEC/CEC:
 Type 3R, 4, 4X
 IP66/IP67
 Simultaneous Exposure
 Suitable for Use in Wet Locations
 American Bureau of Shipping (ABS) Certified

Technical Data

Lamp		Ambient Temperature °C (°F)	Supply Wire Temperature °C (°F)	Class I, Division 2 ①	Gas Groups	NEC/CEC			Gas/Dust
Model	Type					Class I, Zone 2 Group IIC	Dust Class II, Division 1, Groups E, F and G ②	Zone 20, Group IIIC	
MLLED2	LED	40 (104)	90 (194)	T5	A, B, C, D	T5	T6	T6	T4A
	LED	55 (131)	90 (194)	T5		T5	T6	T6	T4A
MLLED3	LED	40 (104)	90 (194)	T5		T5	T6	T6	T5
	LED	55 (131)	90 (194)	T5		T5	T6	T6	T5
MLLED4	LED	40 (104)	90 (194)	T4A		T4	T6	T6	T4A
	LED	55 (131)	90 (194)	T4A		T4	T6	T6	T4A

“T” Numbers Represent the Maximum Internal Temperature ① or Maximum Surface Temperature ②

“T” #	NEC/CEC															
	T1	350	325	T2	T2A	T2B	T2C	T2D	T3	T3A	T3B	T3C	T4	T4A	T5	T6
Temp. Range °C (°F)	351-450 (664-842)	326-350 (619-662)	301-325 (574-617)	281-300 (538-572)	261-280 (502-536)	231-260 (448-500)	216-230 (421-446)	201-215 (394-419)	181-200 (358-392)	166-180 (331-356)	161-165 (322-329)	136-160 (277-320)	121-135 (250-275)	101-120 (214-248)	86-100 (187-212)	85 (185)

① T numbers represent the maximum internal temperature for Class I, Division 2 and Class I, Zone 2 locations designated by the NEC.
 ② T numbers represent the maximum surface temperature under a dust blanket for Class II, Division 1 as designated by the NEC.

Mercmaster™ LED Low Profile Luminaires with Emergency Battery Backup

Enclosed and Gasketed Fixtures

NEC/CEC:
 Class I, Division 2, Groups A,B,C,D
 Class I, Zone 2, Group IIC
 Class II, Division 1, Groups E,F,G
 Zone 21, Group IIIC
 Class II, Division 2, Groups F,G
 Class III

NEC/CEC:
 Type 3R, 4, 4X
 IP66/IP67
 Simultaneous Exposure
 Suitable for Use in Wet Locations
 American Bureau of Shipping (ABS) Certified

Electrical Specification

Model	Line Current Amps (50/60Hz)	Input Power	Power Factor	THD	Lumens ①			CRI ②	Color Temp CCT	Equivalent HID Luminaire
					Polycarbonate Clear Globe	Polycarbonate Diffused Globe	Glass Clear Globe			
NEMA Type V										
MLLED2	.27 @120V .13 @277V	33.0	> .94	< 15%	3200	3100	3300	>70	5000K	70-100 W
MLLED3	.33 @120V .16 @277V	40.0	> .96	< 15%	4200	4100	4400	>70	5000K	100-150 W
MLLED4	.42 @120V .2 @277V	49.0	> .97	< 15%	5300	5150	5500	>70	5000K	150-175 W
90 Minute Emergency Mode										
MLLED2					1400	1350	1450			
MLLED3					1400	1350	1450			
MLLED4					1400	1350	1450			

Model	Line Current Amps (50/60Hz)	Input Power	Power Factor	THD	Lumens ①			CRI ②	Color Temp CCT	Equivalent HID Luminaire
					Polycarbonate Clear Globe	Polycarbonate Diffused Globe	Glass Clear Globe			
NEMA Type V										
MLLED2	.27 @120V .13 @277V	33.0	> .94	< 15%	3200	3100	3100	>70	4000K	70-100 W
MLLED3	.33 @120V .16 @277V	40.0	> .96	< 15%	4200	3900	4200	>70	4000K	100-150 W
MLLED4	.42 @120V .2 @277V	49.0	> .97	< 15%	5000	4900	5200	>70	4000K	150-175 W
90 Minute Emergency Mode										
MLLED2					1270	1200	1330			
MLLED3					1270	1200	1330			
MLLED4					1270	1200	1330			

Model	Line Current Amps (50/60Hz)	Input Power	Power Factor	THD	Lumens ①			CRI ②	Color Temp CCT	Equivalent HID Luminaire
					Polycarbonate Clear Globe	Polycarbonate Diffused Globe	Glass Clear Globe			
NEMA Type V										
MLLED2	.27 @120V .13 @277V	33.0	> .9	< 15%	3000	2900	3100	>70	3000K	70-100 W
MLLED3	.33 @120V .16 @277V	40.0	> .9	< 15%	3900	3800	4100	>70	3000K	100-150 W
MLLED4	.42 @120V .2 @277V	49.0	> .9	< 15%	4900	4800	5000	>70	3000K	150-175 W
90 Minute Emergency Mode										
MLLED2					1150	1100	1200			
MLLED3					1150	1100	1200			
MLLED4					1150	1100	1200			

① All lumen values are typical (tolerance +/- 10%).
 ② 70 minimum.

LED/AREA: NEC/CEC EMERGENCY

APPLETON™

Mercmaster™ LED Low Profile Luminaires with Emergency Battery Backup

Enclosed and Gasketed Fixtures

NEC/CEC:
 Class I, Division 2, Groups A,B,C,D
 Class I, Zone 2, Group IIC
 Class II, Division 1, Groups E,F,G
 Zone 21, Group IIC
 Class II, Division 2, Groups F,G
 Class III

NEC/CEC:
 Type 3R, 4, 4X
 IP66/IP67
 Simultaneous Exposure
 Suitable for Use in Wet Locations
 American Bureau of Shipping (ABS) Certified

Automatic Testing System (ATS)	
Functional	Full Duration
Starts within 24 to 45 hours after the initial powerup of the module	Starts within 5 to 26 days after the initial power of the module
Occurs every 14 days after the initial aforementioned functional test	Occurs every 364 days after the initial aforementioned functional test
Lasts for 5 minutes	Lasts for the full duration of the rated emergency period

At the completion of functional and full duration tests, LED indicator will display the status of the emergency luminaire when AC is present

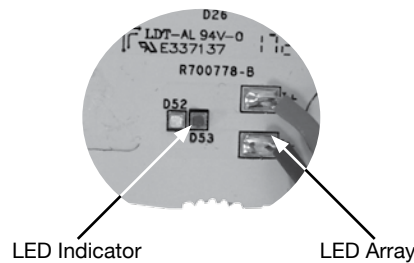

Color	LED Signals	
	Timing	Description
Green	1 sec ON: 1 sec OFF	Normal charging ok, Battery not yet fully charged, No fault detected, Testing ok
Green	0.25 sec ON: 0.25 sec OFF	Functional / Duration Self-Test on-going
Green	Steady ON	Charging ok, Battery fully charged, No fault detected, Testing ok
Red	1 sec ON: 1 sec OFF	Fault condition. Installation issue. Battery is reverse, not connected or shorted. Functional test failure, full duration test failure
LED Indicators OFF, LED Array ON	LED Indicator Lights (Red and Green) OFF	No AC, Emergency mode ON

LED / AREA: NEC/CEC EMERGENCY

APPLETON

Mercmaster™ LED Low Profile Luminaires with Emergency Battery Backup

Enclosed and Gasketed Fixtures

NEC/CEC:
 Class I, Division 2, Groups A,B,C,D
 Class I, Zone 2, Group II C
 Class II, Division 1, Groups E,F,G
 Zone 21, Group II C
 Class II, Division 2, Groups F,G
 Class III

NEC/CEC:
 Type 3R, 4, 4X
 IP66/IP67
 Simultaneous Exposure
 Suitable for Use in Wet Locations
 American Bureau of Shipping (ABS) Certified

	Hub Size	Lumen Level	With Type V Polycarbonate Globe ①	With Type V Polycarbonate Diffused Globe ①	Glass Globe ① ②
--	----------	-------------	-----------------------------------	--	-----------------

Pendant — One Hub



3/4	3K	MLLEDA22XP5BUH	MLLEDA22XD5BUH	MLLEDA22XG5BUH
3/4	4K	MLLEDA32XP5BUH	MLLEDA32XD5BUH	MLLEDA32XG5BUH
3/4	5K	MLLEDA42XP5BUH	MLLEDA42XD5BUH	MLLEDA42XG5BUH
1	3K	MLLEDA23XP5BUH	MLLEDA23XD5BUH	MLLEDA23XG5BUH
1	4K	MLLEDA33XP5BUH	MLLEDA33XD5BUH	MLLEDA33XG5BUH
1	5K	MLLEDA43XP5BUH	MLLEDA43XD5BUH	MLLEDA43XG5BUH

Ceiling — Five Hubs, Four Close-up Plugs



3/4	3K	MLLEDC22XP5BUH	MLLEDC22XD5BUH	MLLEDC22XG5BUH
3/4	4K	MLLEDC32XP5BUH	MLLEDC32XD5BUH	MLLEDC32XG5BUH
3/4	5K	MLLEDC42XP5BUH	MLLEDC42XD5BUH	MLLEDC42XG5BUH
1	3K	MLLEDC23XP5BUH	MLLEDC23XD5BUH	MLLEDC23XG5BUH
1	4K	MLLEDC33XP5BUH	MLLEDC33XD5BUH	MLLEDC33XG5BUH
1	5K	MLLEDC43XP5BUH	MLLEDC43XD5BUH	MLLEDC43XG5BUH

Pendant Cone — One Hub, Rigid Mounting



3/4	3K	MLLEDD22XP5BUH	MLLEDD22XD5BUH	MLLEDD22XG5BUH
3/4	4K	MLLEDD32XP5BUH	MLLEDD32XD5BUH	MLLEDD32XG5BUH
3/4	5K	MLLEDD42XP5BUH	MLLEDD42XD5BUH	MLLEDD42XG5BUH
1	3K	MLLEDD23XP5BUH	MLLEDD23XD5BUH	MLLEDD23XG5BUH
1	4K	MLLEDD33XP5BUH	MLLEDD33XD5BUH	MLLEDD33XG5BUH
1	5K	MLLEDD43XP5BUH	MLLEDD43XD5BUH	MLLEDD43XG5BUH

LED/AREA: NEC/CEC EMERGENCY

APPLETON™

① X = Color temperature; C = Cool, 5000K CCT, N = Neutral, 4000K CCT, W = Warm, 3000K CCT. **MLLEDW43CP5BUH.**





② Guards are available for fixtures with glass or polycarbonate globe. See following pages for accessory ordering information.

Mercmaster™ LED Low Profile Luminaires with Emergency Battery Backup

Enclosed and Gasketed Fixtures

NEC/CEC:
 Class I, Division 2, Groups A,B,C,D
 Class I, Zone 2, Group IIC
 Class II, Division 1, Groups E,F,G
 Zone 21, Group IIC
 Class II, Division 2, Groups F,G
 Class III

NEC/GEC:
 Type 3R, 4, 4X
 IP66/IP67
 Simultaneous Exposure
 Suitable for Use in Wet Locations
 American Bureau of Shipping (ABS) Certified

	Hub Size	Lumen Level	With Type V Polycarbonate Globe ①	With Type V Polycarbonate Diffused Globe ①	Glass Globe ①②
90° Stanchion — One Hub					
	1 - 1/4	3K	MLLEDR24XP5BUH	MLLEDR24XD5BUH	MLLEDR24XG5BUH
	1 - 1/4	4K	MLLEDR34XP5BUH	MLLEDR34XD5BUH	MLLEDR34XG5BUH
	1 - 1/4	5K	MLLEDR44XP5BUH	MLLEDR44XD5BUH	MLLEDR44XG5BUH
	1 - 1/2	3K	MLLEDR25XP5BUH	MLLEDR25XD5BUH	MLLEDR25XG5BUH
	1 - 1/2	4K	MLLEDR35XP5BUH	MLLEDR35XD5BUH	MLLEDR35XG5BUH
	1 - 1/2	5K	MLLEDR45XP5BUH	MLLEDR45XD5BUH	MLLEDR45XG5BUH
25° Stanchion — One Hub					
	1 - 1/4	3K	MLLEDS24XP5BUH	MLLEDS24XD5BUH	MLLEDS24XG5BUH
	1 - 1/4	4K	MLLEDS34XP5BUH	MLLEDS34XD5BUH	MLLEDS34XG5BUH
	1 - 1/4	5K	MLLEDS44XP5BUH	MLLEDS44XD5BUH	MLLEDS44XG5BUH
	1 - 1/2	3K	MLLEDS25XP5BUH	MLLEDS25XD5BUH	MLLEDS25XG5BUH
	1 - 1/2	4K	MLLEDS35XP5BUH	MLLEDS35XD5BUH	MLLEDS35XG5BUH
	1 - 1/2	5K	MLLEDS45XP5BUH	MLLEDS45XD5BUH	MLLEDS45XG5BUH
Wall — Five Hubs, Four Close-Up Plugs					
	3/4	3K	MLLEDW22XP5BUH	MLLEDW22XD5BUH	MLLEDW22XG5BUH
	3/4	4K	MLLEDW32XP5BUH	MLLEDW32XD5BUH	MLLEDW32XG5BUH
	3/4	5K	MLLEDW42XP5BUH	MLLEDW42XD5BUH	MLLEDW42XG5BUH
	1	3K	MLLEDW23XP5BUH	MLLEDW23XD5BUH	MLLEDW23XG5BUH
	1	4K	MLLEDW33XP5BUH	MLLEDW33XD5BUH	MLLEDW33XG5BUH
	1	5K	MLLEDW43XP5BUH	MLLEDW43XD5BUH	MLLEDW43XG5BUH
Trunnion — One Hub					
	3/4	3K	MLLEDT22XP5BUH	MLLEDT22XD5BUH	MLLEDT22XG5BUH
	3/4	4K	MLLEDT32XP5BUH	MLLEDT32XD5BUH	MLLEDT32XG5BUH
	3/4	5K	MLLEDT42XP5BUH	MLLEDT42XD5BUH	MLLEDT42XG5BUH
	1	3K	MLLEDT23XP5BUH	MLLEDT23XD5BUH	MLLEDT23XG5BUH
	1	4K	MLLEDT33XP5BUH	MLLEDT33XD5BUH	MLLEDT33XG5BUH
	1	5K	MLLEDT43XP5BUH	MLLEDT43XD5BUH	MLLEDT43XG5BUH

① X = Color temperature; C = Cool, 5000K CCT, N = Neutral, 4000K CCT, W = Warm, 3000K CCT. Example: **MLLEDW43WP5BUH**.
 ② Guards are available for fixtures with glass or polycarbonate globe. See following pages for accessory ordering information.

Mercmaster™ LED Low Profile Luminaires with Emergency Battery Backup

Enclosed and Gasketed Fixtures

NEC/CEC:
 Class I, Division 2, Groups A,B,C,D
 Class I, Zone 2, Group IIC
 Class II, Division 1, Groups E,F,G
 Zone 21, Group IIC
 Class II, Division 2, Groups F,G
 Class III







NEC/CEC:
 Type 3R, 4, 4X
 IP66/IP67
 Simultaneous Exposure
 Suitable for Use in Wet Locations
 American Bureau of Shipping (ABS) Certified

Fixture Unit — Ballast Body and Globe



Lumen Level	LED Wattage	Light Level Equivalent	NEMA Type	Catalog Number ①		
				With Type V Polycarbonate Globe ①②	With Type V Polycarbonate Diffused Globe ①②	Glass Globe ①②③
NEC/CEC Certified Fixture Housing - For Hazardous Locations						
3K	28	70-100W HPS	Type V	MLLED2XP5BUH	MLLED2XD5BUH	MLLED2XG5BUH
4K	38	100-150W HPS	Type V	MLLED3XP5BUH	MLLED3XD5BUH	MLLED3XG5BUH
5K	48	150-175W HPS	Type V	MLLED4XP5BUH	MLLED4XD5BUH	MLLED4XG5BUH

Mounting Hoods

	Description	Hub Size	Catalog Number
Pendant 	One Hub	3/4	KPA-75
		1	KPA-100
		M20	KPA-M20
Pendant Cone 	One Hub, Rigid Mounting	3/4	KPCH-75
		1	KPCH-100
		M20	KPCH-M20
Trunion 	Five Hubs, Four Close-Up Plugs	3/4	KPCT-75
		1	KPCT-100
Ceiling 	Five Hubs, Four Close-Up Plugs	3/4	KPC-75
		1	KPC-100
		M20	KPC-M20
Wall 	Five Hubs, Four Close-Up Plugs	3/4	KPWB-75
		1	KPWB-100
		M20	KPWB-M20
25° Stanchion 	One Hub	1-1/4	KPS-125
		1-1/2	KPS-150
90° Stanchion 	One Hub	1-1/4	KPST-125
		1-1/2	KPST-150

① For 120-277 Vac, use suffix **-BU**.

② **X** = Color temperature; **C** = Cool, 5000K CCT, **N** = Neutral, 4000K CCT, **W** = Warm, 3000K CCT. Example: **MLLED2CP5BUH**.

③ Guards are available for fixtures with glass globe. See following pages for accessory ordering information.

④ Must be ordered separately.

LED/AREA: NEC/CEC EMERGENCY

APPLETON™



Mercmaster™ LED Low Profile Luminaires with Emergency Battery Backup

Enclosed and Gasketed Fixtures





NEC/CEC:
 Class I, Division 2, Groups A,B,C,D
 Class I, Zone 2, Group IIC
 Class II, Division 1, Groups E,F,G
 Zone 21, Group IIIC
 Class II, Division 2, Groups F,G
 Class III

NEC/CEC:
 Type 3R, 4, 4X
 IP66/IP67
 Simultaneous Exposure
 Suitable for Use in Wet Locations
 American Bureau of Shipping (ABS) Certified

Replacement Parts

	Description	Catalog Number
Globes and Gaskets		
	Clear Globe (polycarbonate)	VPGL-LED
	Diffused Globe (polycarbonate)	VPGL-DIFF
	Glass Globe	VPGL-GLASS

Accessories

	Description	Catalog Number
White Polyester Reflectors		
 30° Angle	30° Angle	CMR-4AN
Exit Sign		
	Emergency Exit sign	EXR-400
Guards		
 Glass Globe Guard	Glass Globe Guard	MGU1
Safety Cable		
	Stainless steel.	LEDSC

Replacement Battery Pack

BPMLLED

Replacement Battery Management Module

BMMLLED

Replacement Fuse (Emergency system)

MLF3

Replacement Drivers and Battery Management Module with Battery

	Voltage	Driver Wattage	Luminaire Model	Constant Current Settings	Catalog Number
	BU	50 Watt	MLLED2	415mA	APMS050C135UD41
	BU	50 Watt	MLLED3	550mA	APMS050C135UD55
	BU	50 Watt	MLLED4	690mA	APMS050C135UD69

LED / AREA: NEC/CEC EMERGENCY

APPLETON™

Mercmaster™ LED Low Profile Luminaires with Emergency Battery Backup

Enclosed and Gasketed Fixtures

NEC/CEC:
 Class I, Division 2, Groups A,B,C,D
 Class I, Zone 2, Group IIC
 Class II, Division 1, Groups E,F,G
 Zone 21, Group IIC
 Class II, Division 2, Groups F,G
 Class III

NEC/CEC:
 Type 3R, 4, 4X
 IP66/IP67
 Simultaneous Exposure
 Suitable for Use in Wet Locations
 American Bureau of Shipping (ABS) Certified

Dimensions in Millimeters (Inches)

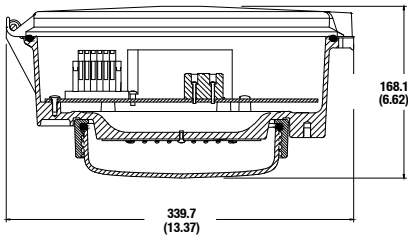

Pendant Mount

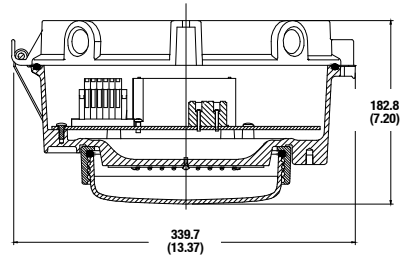

Ceiling Mount

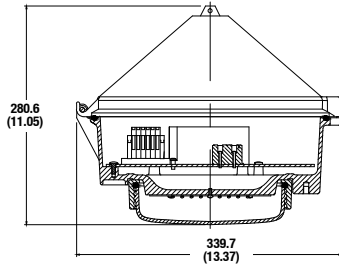

Pendant Cone Mount

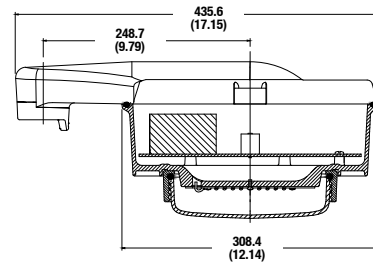

90° Stanchion Mount

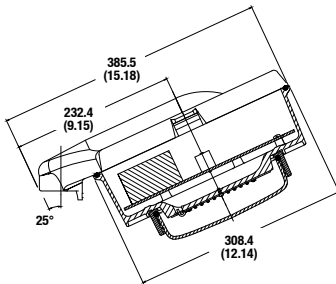

25° Stanchion Mount

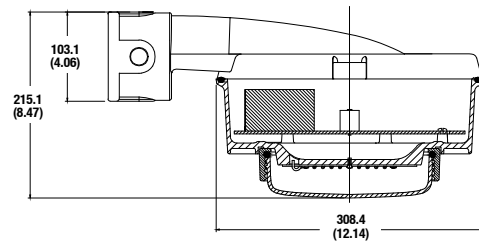

Wall Mount

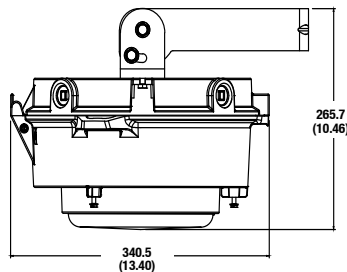

Trunnion Mount

LED / AREA: NEC / CEC EMERGENCY

APPLETON™

Mercmaster™ LED Low Profile Luminaires with Emergency Battery Backup

Enclosed and Gasketed Fixtures

NEC/CEC:
 Class I, Division 2, Groups A,B,C,D
 Class I, Zone 2, Group IIC
 Class II, Division 1, Groups E,F,G
 Zone 21, Group IIIC
 Class II, Division 2, Groups F,G
 Class III

NEC/CEC:
 Type 3R, 4, 4X
 IP66/IP67
 Simultaneous Exposure
 Suitable for Use in Wet Locations
 American Bureau of Shipping (ABS) Certified

Dimensions in Millimeters (Inches)

With Polycarbonate Globe

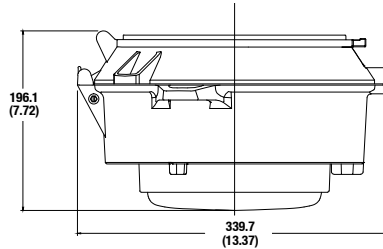

CH-Adapter-Centric

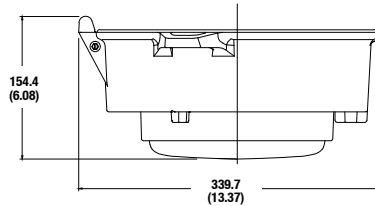

Driver Housing

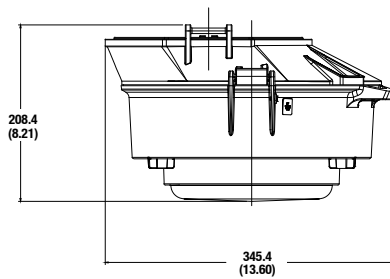

CH-Adapter Off-Centric

Mercmaster LED Low Profile Fixture and Mounting Hood Weights

Description	Weight kg (lb)
Fixture Unit	5.8 (13.80)
Pendant Mounting Hood	1.0 (2.25)
Pendant Cone Mounting Hood	1.1 (2.50)
Ceiling Mounting Hood	1.4 (3.00)
Wall Mounting Hood	1.8 (4.00)
25° Stanchion Mounting Hood	1.5 (3.25)
90° Stanchion Mounting Hood	1.7 (3.75)
CH-Adapter-Centric	0.9 (2.00)
CH-Adapter-Off-Centric	0.9 (2.00)

Mercmaster™ LED Low Profile Luminaires with Emergency Battery Backup

Enclosed and Gasketed Fixtures

NEC/CEC:
 Class I, Division 2, Groups A,B,C,D
 Class I, Zone 2, Group IIC
 Class II, Division 1, Groups E,F,G
 Zone 20, Group IIIC
 Class II, Division 2, Groups F,G
 Class III

NEC/CEC:
 Type 3R, 4, 4X
 IP66/IP67
 Simultaneous Exposure
 Suitable for Use in Wet Locations
 Marine Outside Type (Salt Water) For USA
 ONLY ⌘
 American Bureau of Shipping (ABS) Certified

Photometric Data — DATA SHOWN IS ABSOLUTE

Type V, Clear Polycarbonate 5000K CCT
 REPORT NUMBER: MLLED2CP5BUH+EMR

Luminaire Lumens 1,404

POLAR CANDELA DISTRIBUTION

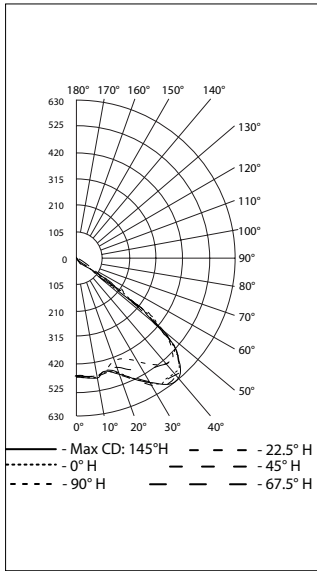

ISOFOOT CANDLE PLOT

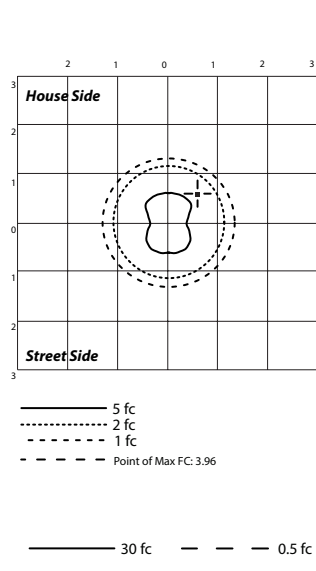

ZONAL LUMEN SUMMARY

Zone	Lumens	% Luminaire
0-30	407.0	29%
0-40	763.6	54.4%
0-60	1,388.0	98.8%
60-90	16.4	1.2%
70-100	3.5	0.3%
90-120	0.1	0%
0-90	1,404.4	100%
90-180	0.1	0%
0-180	1,404.5	100%

LUMENS PER ZONE

Zone	Lumens	% Total	Zone	Lumens	% Total
0-10	44.3	3.2%	90-100	0.1	0%
10-20	130.2	9.3%	100-110	0	0%
20-30	232.5	16.6%	110-120	0	0%
30-40	356.6	25.4%	120-130	0	0%
40-50	424.6	30.2%	130-140	0	0%
50-60	199.9	14.2%	140-150	0	0%
60-70	12.9	0.9%	150-160	0	0%
70-80	2.4	0.2%	160-170	0	0%
80-90	1.1	0.1%	170-180	0	0%

Type V, Diffused Polycarbonate 5000K CCT
 REPORT NUMBER: MLLED2CD5BUH+EMR

Luminaire Lumens 1,369

POLAR CANDELA DISTRIBUTION

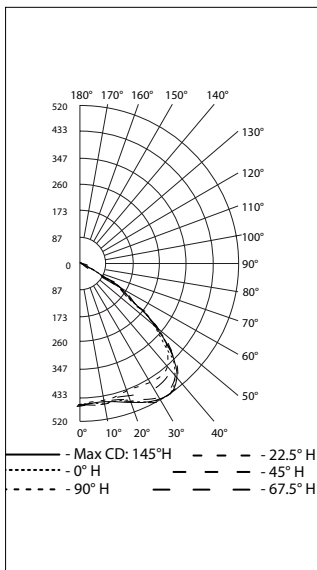

ISOFOOT CANDLE PLOT

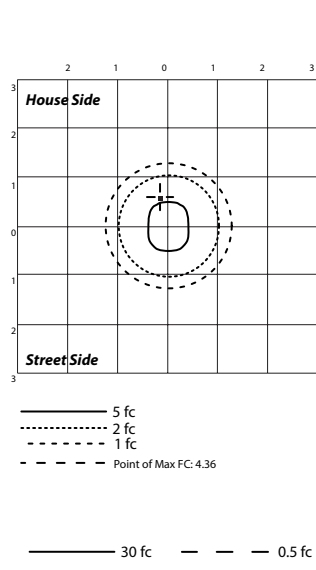

ZONAL LUMEN SUMMARY

Zone	Lumens	% Luminaire
0-30	395.3	28.9%
0-40	702.3	51.3%
0-60	1,231.5	89.9%
60-90	126.7	9.2%
70-100	44.8	3.3%
90-120	10.6	0.8%
0-90	1,358.2	99.2%
90-180	11.1	0.8%
0-180	1,369.3	100%

LUMENS PER ZONE

Zone	Lumens	% Total	Zone	Lumens	% Total
0-10	43.5	3.2%	90-100	4.2	0.3%
10-20	129.9	9.5%	100-110	4.7	0.3%
20-30	221.9	16.2%	110-120	1.8	0.1%
30-40	307.0	22.4%	120-130	0.5	0%
40-50	321.3	23.5%	130-140	0	0%
50-60	208.0	15.2%	140-150	0	0%
60-70	86.0	6.3%	150-160	0	0%
70-80	31.5	2.3%	160-170	0	0%
80-90	9.1	0.7%	170-180	0	0%

LED/AREA: NEC/CEC EMERGENCY

APPLETON™

Mercmaster™ LED Low Profile Luminaires with Emergency Battery Backup

Enclosed and Gasketed Fixtures

NEC/CEC:
 Class I, Division 2, Groups A,B,C,D
 Class I, Zone 2, Group IIC
 Class II, Division 1, Groups E,F,G
 Zone 20, Group IIIC
 Class II, Division 2, Groups F,G
 Class III

NEC/CEC:
 Type 3R, 4, 4X
 IP66/IP67
 Simultaneous Exposure
 Suitable for Use in Wet Locations
 Marine Outside Type (Salt Water) For USA
 ONLY %
 American Bureau of Shipping (ABS) Certified

Photometric Data — DATA SHOWN IS ABSOLUTE

Type V, Clear Glass 5000K CCT

REPORT NUMBER: MLLED2CG5BUH+EMR

Luminaire Lumens 1,460

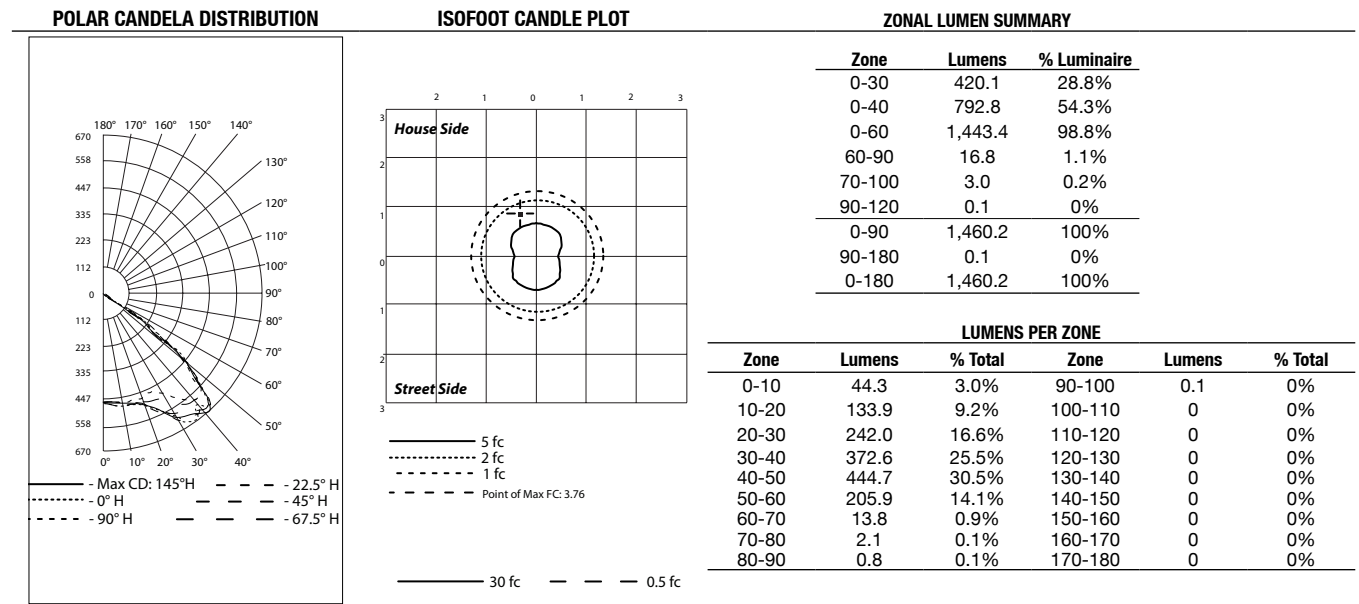

Type V, Clear Polycarbonate 4000K CCT

REPORT NUMBER: MLLED4NG5BUH+EMR

Luminaire Lumens 1,330

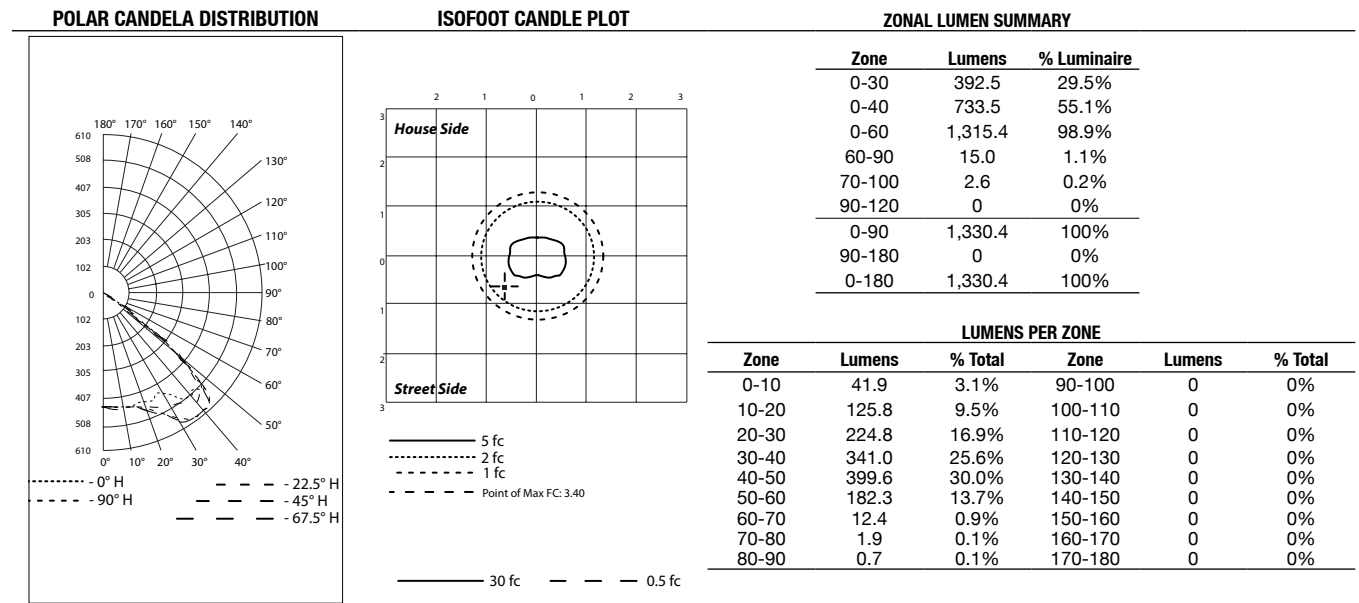

Mercmaster™ LED Low Profile Luminaires with Emergency Battery Backup

Enclosed and Gasketed Fixtures

NEC/CEC:
 Class I, Division 2, Groups A,B,C,D
 Class I, Zone 2, Group IIC
 Class II, Division 1, Groups E,F,G
 Zone 20, Group IIIC
 Class II, Division 2, Groups F,G
 Class III

NEC/CEC:
 Type 3R, 4, 4X
 IP66/IP67
 Simultaneous Exposure
 Suitable for Use in Wet Locations
 Marine Outside Type (Salt Water) For USA
 ONLY %
 American Bureau of Shipping (ABS) Certified

Photometric Data – DATA SHOWN IS ABSOLUTE

Type V, Clear Glass 4000K CCT

REPORT NUMBER: MLLED4WG5BUH+EMR

Luminaire Lumens 1,207

POLAR CANDELA DISTRIBUTION

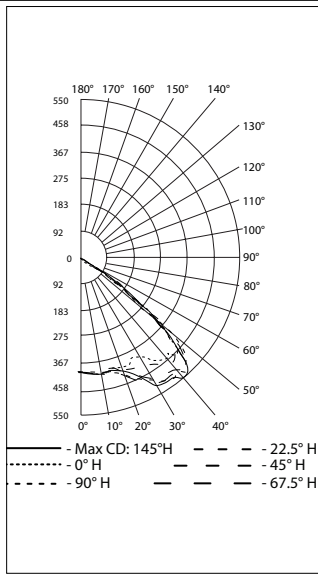

ISOFOOT CANDLE PLOT

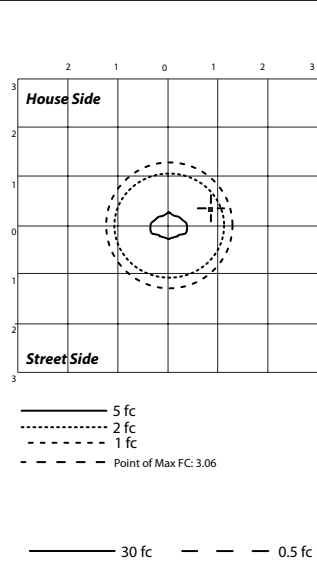

ZONAL LUMEN SUMMARY

Zone	Lumens	% Luminaire
0-30	355.1	29.4%
0-40	659.9	54.6%
0-60	1,193.4	98.8%
60-90	14.4	1.2%
70-100	2.4	0.2%
90-120	0	0%
0-90	1,207.8	100%
90-180	0	0%
0-180	1,207.8	100%

LUMENS PER ZONE

Zone	Lumens	% Total	Zone	Lumens	% Total
0-10	38.1	3.2%	90-100	0	0%
10-20	114.1	9.4%	100-110	0	0%
20-30	202.9	16.8%	110-120	0	0%
30-40	304.8	25.2%	120-130	0	0%
40-50	360.5	29.8%	130-140	0	0%
50-60	173.0	14.3%	140-150	0	0%
60-70	12.0	1.0%	150-160	0	0%
70-80	1.7	0.1%	160-170	0	0%
80-90	0.7	0.1%	170-180	0	0%

LED / AREA: NEC / CEC EMERGENCY

APPLETON™