

Installation Equipments



Plug and Sockets

BCZ85 Series Explosion-proof Plug and Sockets

- ◆ Explosion protection to
 - CENELEC
 - IEC
 - NEC
- ◆ Can be used in
 - Zone 1 and Zone 2
 - Zone 21 and Zone 22
- ◆ Four enclosure types; Four current ratings (16A, 32A, 63A, 125A); 3P, 4P or 5P versions.
- ◆ Plug insert with power on, power off and socket closed with plug removed.
- ◆ Copper-free aluminium enclosure; powder coated external surface.



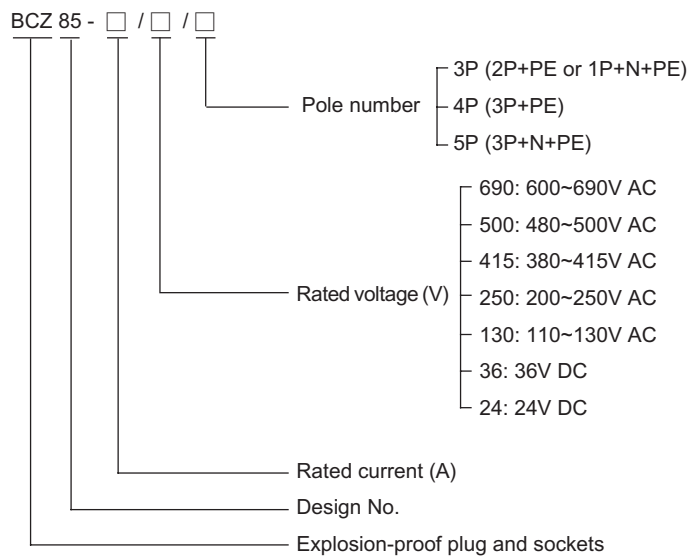

























■ Catalogue number logic



Zones 1&2; 21&22

Plug and Sockets

BCZ85 Series Explosion-proof Plug and Sockets

Selection table							
Type	Voltage (V)	Current (A)	Pole number	Schematic diagram	h	Ordering code	Weight (kg)
BCZ85-16/□/□	600~690V AC	16	3P+PE		5	30147	1.65
	480~500V AC	16	3P+PE		7	30148	1.65
	380~415V AC	16	3P+N+PE		6	30149	1.65
		16	3P+PE		6	30150	1.65
	200~250V AC	16	3P+N+PE		6	30151	1.65
		16	3P+PE		9	30152	1.65
		16	1P+N+PE		6	30153	1.65
	110~130V AC	16	1P+N+PE		4	30154	1.65
	36V DC	16	2P+PE		12	30155	1.65
	24V DC	16	2P+PE		12	30157	1.65
BCZ85-32/□/□	600~690V AC	32	3P+PE		5	30159	2.95
	480~500V AC	32	3P+PE		7	30160	2.95
	380~415V AC	32	3P+N+PE		6	30161	2.95
		32	3P+PE		6	30162	2.95
	200~250V AC	32	3P+N+PE		6	30163	2.95
		32	3P+PE		9	30164	2.95
BCZ85-63/□/□	600~690V AC	63	3P+PE		5	30165	4.00
	480~500V AC	63	3P+PE		7	30166	4.00
	380~415V AC	63	3P+N+PE		6	30167	4.00
		63	3P+PE		6	30168	4.00
	200~250V AC	63	3P+N+PE		6	30169	4.00
		63	3P+PE		9	30170	4.00
BCZ85-125/□/□	600~690V AC	125	3P+PE		5	30171	20.00
	480~500V AC	125	3P+PE		7	30172	20.00
	380~415V AC	125	3P+N+PE		6	30173	20.00
		125	3P+PE		6	30174	20.00
	200~250V AC	125	3P+N+PE		6	30175	20.00
		125	3P+PE		9	30176	20.00

Plug and Sockets

BCZ85 Series Explosion-proof Plug and Sockets

Technical data

Explosion-proof plug and sockets **BCZ85-□/□/□**

Explosion protection

Ⓔ II 2 GD Ex d IIC T6 Gb / Ex tD A21 T80°C IP66

Certificates

Nemko 11 ATEX____; FM (USA); GOST.R (Russia); IECEx

Conformity to standards

EN 60079-0:2009, EN 60079-1:2007, EN 61241-0:2006, EN 61241-1:2004

IEC 60079-0:2007, IEC 60079-1:2007, IEC 61241-0:2004, IEC 61241-1:2004

Enclosure material

Copper-free aluminium; powder coated external surface

Enclosure colour

Window grey (RAL7040)

Exposed fastener

Stainless steel

Rated voltage

Max. 690V AC

Rated current

16A, 32A, 63A, 125A

Pole number

3P (2P+PE, 1P+N+PE), 4P (3P+PE), 5P (3P+N+PE)

Degree of protection

IP66

Ambient temperature

-60°C ~ +55°C

Cable entry of socket

2 x M25 x 1.5 (16A), 2 x M32 x 1.5 (32A), 2 x M40 x 1.5 (63A), 2 x M63 x 1.5 (125A)

Cable entry of plug

1 x M25 x 1.5 (16A), 1 x M32 x 1.5 (32A), 1 x M40 x 1.5 (63A), 1 x M63 x 1.5 (125A)

Cable gland (optional)

DQM-II (Ex d) or DQM-III (Ex d) is recommended. Please see P7/20~25.

Dimension drawings (all dimensions in mm) - subject to alteration

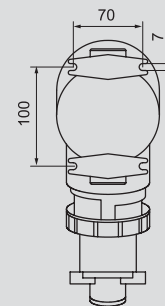
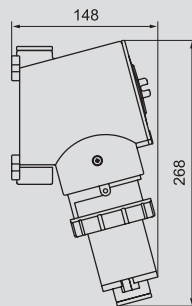
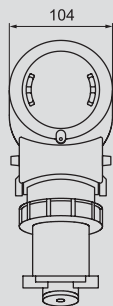

BCZ85-16/□/□

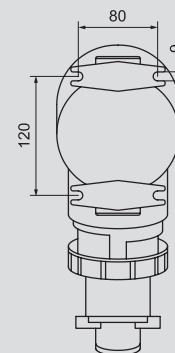
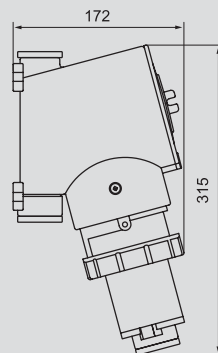
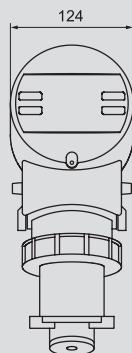

BCZ85-32/□/□

Plug and Sockets

BCZ85 Series Explosion-proof Plug and Sockets

Dimension drawings (all dimensions in mm) - subject to alteration

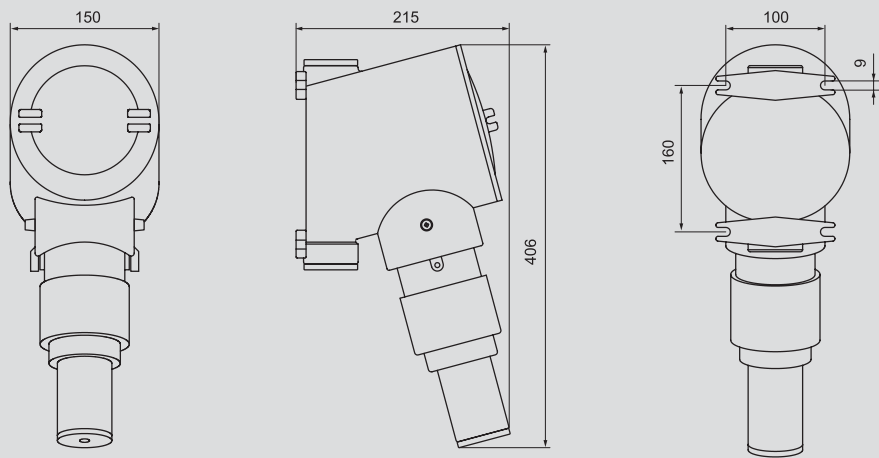

BCZ85-63/□/□

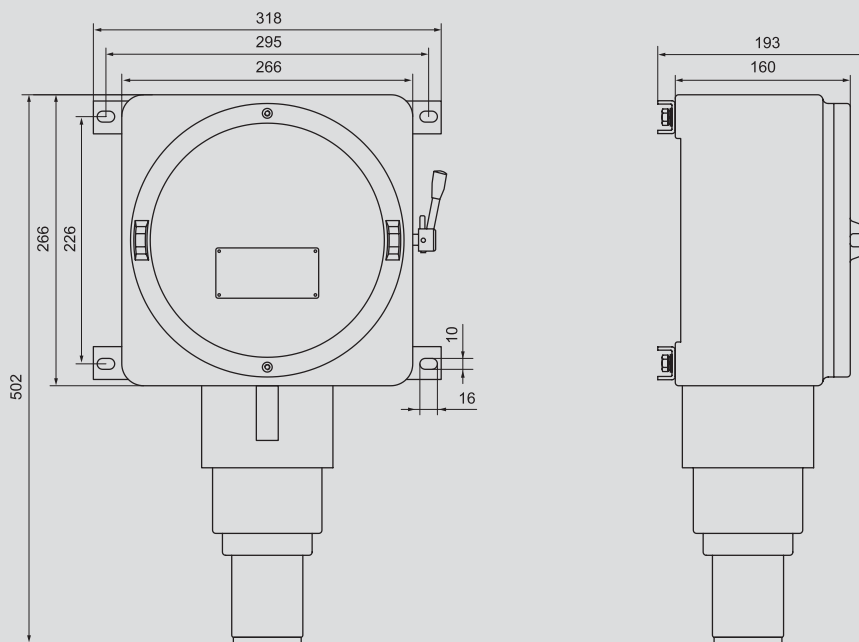

BCZ85-125/□/□