

EUP12A-2HMC (Product No.:103101030101)

Summary

EUP12A-2HMC is a 12W AC/DC constant current mode output LED driver featuring the multiple levels selectable by DIP switch.



Product Features

- Two channel output, output current level selectable by DIP S.W.
- High efficiency up to 85 %
- Built-in active PFC function
- Protections: Short circuit, over load, over Voltage
- Suitable for indoor LED lighting application, such as down light, panel light, and so on



Application



Technical Parameters

Model	EUP12A-2HMC				
Input	Efficiency	>85%@230VAC,Full load			
	Voltage	220VAC-240VAC			
	Frequency Range(Hz)	50/60Hz			
	Power Factor	≥0.95@230VAC,Full load			
	THD(full load)	<10%@230VAC, Full load			
	AC Current(max)	0.09Amax@230VAC			
	Standby power	<0.5W			
	Inrush Current(max)	Cold start,10A(twidth=14us measured at 50% Ipeak)@220VAC			
Output	Current(mA)/Voltage (VDC)	*120mA/9-42VDC/5.04W	150mA/9-42VDC/6.3W	180mA/9-42VDC/7.56W	200mA/9-42VDC/8.4W
	Power(W)	240mA/9-42VDC/10.1W	270mA/9-42VDC/11.34W	300mA/9-40VDC/12W	350mA/9-34VDC/11.9W
	Ripple Current	<3%			
	Channel	2			
	Current Tolerance	±5% ; *120mA ±7%A			
	No load output voltage	60V Max			
Turn on delay Time	<0.75s, at230Vac				
Function	Dimming Type	0/1-10V			
	Dimming Range	0.1%-100% Dimming to off			
	color temperature	3000k-6000k			
Protection	Short Circuit	Close output, recovers automatically after fault removed			
	Over Load	When the output voltage is exceeded, the output current decreases and, recovers automatically when the load is reduced.			
	over Voltage	Close output, recovers automatically after fault removed			
Safety& EMC	Surge	L-N:1KV			
	Withstand Voltage	I/P-O/P: 3750VAC/1min/5mA			
	Safety Standards	EN61347, GB19510			
	EMC Eission	EN55015, EN61000-3-2			
	EMC Immunity	EN61000-4-2, 3, 4, 5, 6, 8, 11; EN61547			
Others	Working Temp.	-20°C -50°C			
	Storage Temp., Humidity	-40°C -85°C, 20-90%RH			
	tc	70°C			
	Material	PC			
	IP Rating	IP20			
	Lifetime	50,000h@tc:70°C			
	Warranty Condition	5 Years			
	Switch Cycle	>25,000 times			
	Packing(weight)	Net weight: 110g±5%/PCS; 50PCS/Carton; 6.3kg±5%/Carton; Carton Size: 319*254*136mm(L*W*H)			
	Dimension	150*43*29mm (L*W*H)			

Current Selection Table

ON	OFF	1	2	3	4	5	6	7	8	9	10	11	12
		*120mA	150mA	180mA	200mA	240mA	270mA	300mA	350mA				
		9-42V	9-42V	9-42V	9-42V	9-42V	9-42V	9-42V	9-40V	9-34V			

Remark: Function default setting is: 120mA (@switch are all OFF state)

Dimension(mm)

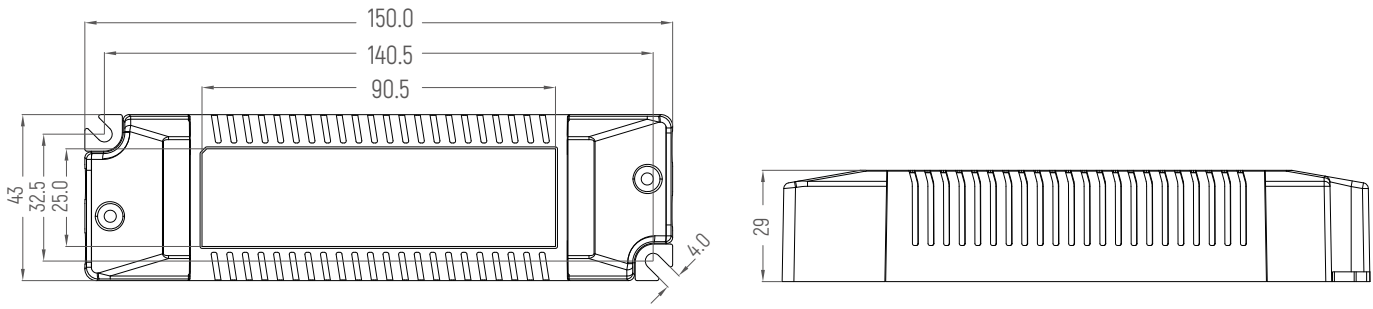

Wiring

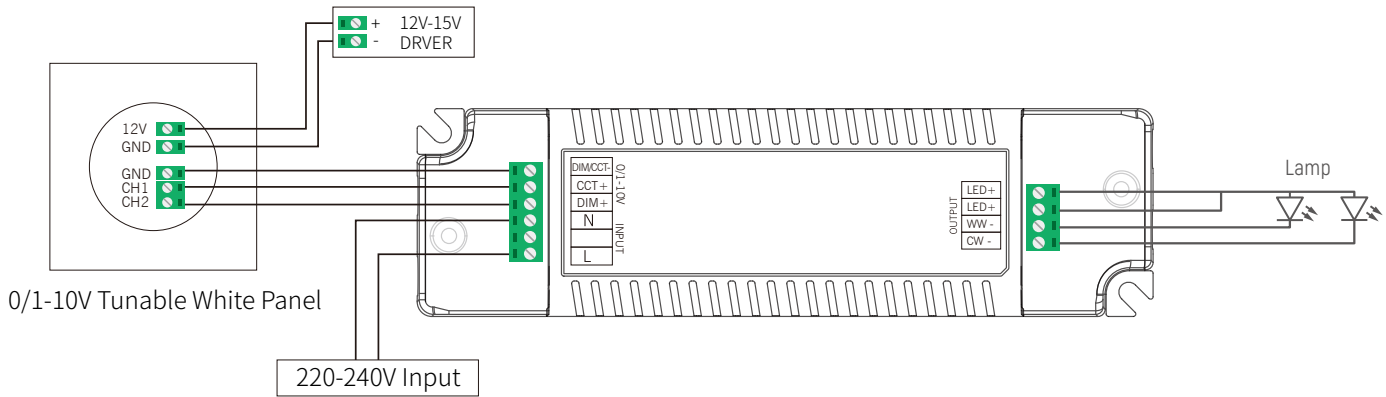

Dimming Curve

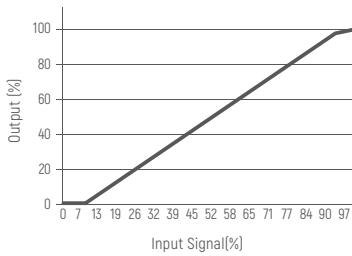

Derating Curve

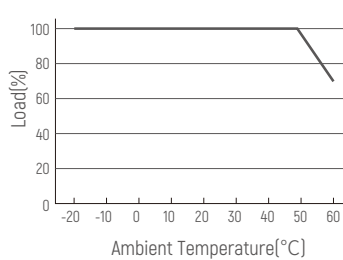

Efficiency Curve

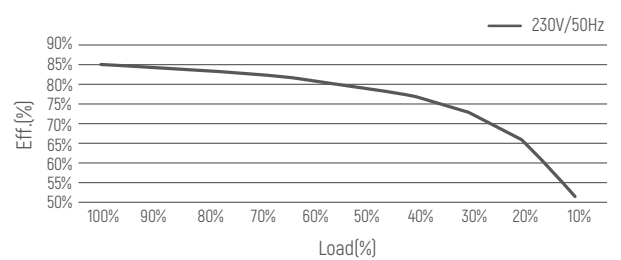

Cautions

- 1.This product should be installed by qualified personnel.
- 2.This product is non waterproof, need to avoid sun and rain.In case of outdoor use, please ensure it is mounted in a water proof enclosure.
- 3.Good heat dissipation conditions extend product life. Please install the product in a well-ventilated environment.
- 4.Please make sure LED power supply output voltage, current is used to meet the product requirements.
- 5.Please ensure that adequate sized cable is used from the controller to the LED lights to carry the current. Please also ensure that the cable is secured tightly in the connector.
- 6.Due to safety concerns, PVC or rubber cord of 0.75- 1.5mm² is recommended for input and output terminal(s)(excluding signal terminals). Flat power cord is not suitable.Ensure all wire connections and polarities are correct before applying power to avoid any damages to the LED lights.
- 7.In case of malfunction, do not repair it yourself.

※ The contents of this manual are updated without prior notice. If the function of the product you are using is inconsistent with the instructions, the function of the product shall prevail.Please contact us if you have any questions .

EUP12A-2HMC (产品代码:103101030101)

概述

EUP12A-2HMC 是一款调光调色恒流调光驱动器，可以提供120/150/180/200/240/270/300/350mA 8档电流的LED驱动器。输出电流可以通过DIP拨码开关简易设置。

产品特点

- 双道恒流输出，多级电流可选
- 效率高达 85%
- 内建主动式PFC功能
- 短路保护，过载保护，过压保护
- 适用于LED室内灯具,比如筒灯，面板灯等



应用



技术参数

型号	EUP12A-2HMC				
输入	效率	>85%@230VAC, 满载			
	电压	220VAC-240VAC			
	频率	50/60Hz			
	功率因素	≥0.95@230VAC, 满载			
	THD	<10%@230VAC, 满载			
	电流	0.09Amax@230VAC			
	待机功耗	<0.5W			
	浪涌电流	冷启动,10A[在 50%Ipeak 下测twidth=14us]@220VAC			
输出	电流/电压/功率	*120mA/9-42VDC/5.04W 240mA/9-42VDC/10.1W	150mA/9-42VDC/6.3W 270mA/9-42VDC/11.34W	180mA/9-42VDC/7.56W 300mA/9-40VDC/12W	200mA/9-42VDC/8.4W 350mA/9-34VDC/11.9W
	波纹电流	<3%			
	通道	2			
	电流精度	±5% *120mA ±7%A			
	空载输出电压	60V Max			
	启动延时	<0.75s, at230Vac			
功能	调光方式	0/1-10V			
	调光范围	0.1%-100%			
	色温值	3000k-6000k			
保护	短路	关闭输出，排除故障后自恢复			
	过载	打嗝，移除故障后自恢复			
	过压	打嗝，移除故障后自恢复			
安全 & 电磁兼容	浪涌	L-N:1KV			
	耐压标准	I/P-O/P: 3750VAC/1min/5mA			
	安全标准	EN61347, GB19510			
	电磁兼容	EN55015, EN61000-3-2			
	EMC抗扰度	EN61000-4-2, 3, 4, 5, 6, 8, 11; EN61547			
其它	工作温度	-20°C~50°C			
	储存温度、湿度	-40°C~85°C, 20-90%RH			
	tc	70°C@220Vac			
	材质	PC			
	防水等级	IP20			
	寿命	50,000小时@tc:70°C			
	质保	5年			
	开关周期	>25,000次			
	包装尺寸(重量)	净重: 110g±5%/PCS; 50PCS/ Carton; 6.3kg±5%/箱; 外箱尺寸: 319*254*136mm[长*宽*高]			
	尺寸	150*43*29mm (长*宽*高)			

电流选择表

ON	OFF	1	2	3	4	5	6	7	8	9	10	11	12
		120mA	150mA	180mA	200mA	240mA	270mA	300mA	350mA				
		9-42V	9-42V	9-42V	9-42V	9-42V	9-42V	9-40V	9-34V				

备注：出厂默认设置电流为120mA(1,2,3在OFF状态)

尺寸(mm)

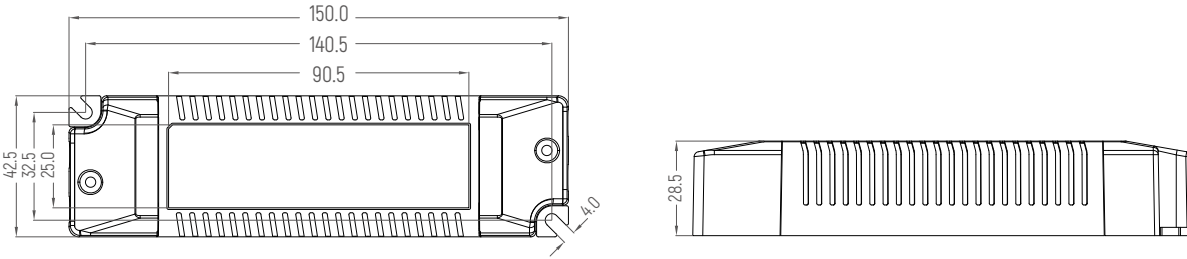

接线图

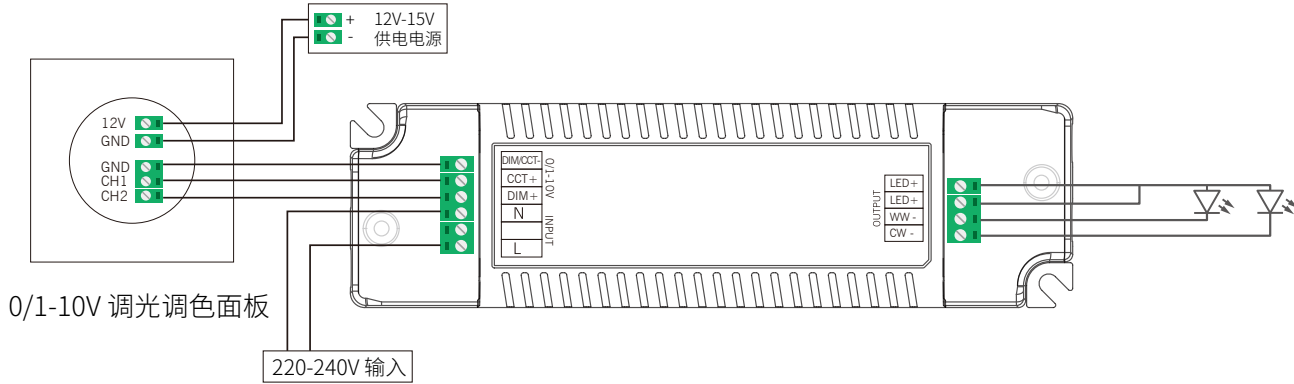

调光曲线

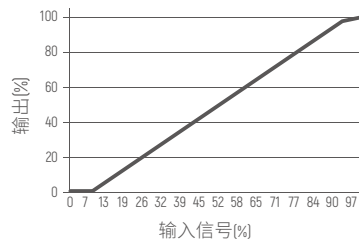

降额曲线

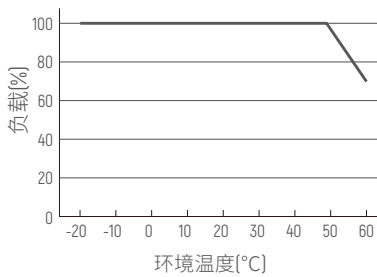

效率曲线

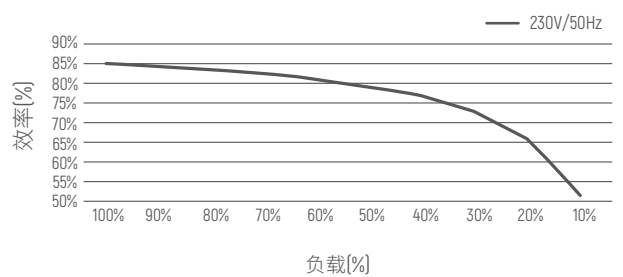

注意事项:

- 1、本产品请由具有专业资格的人员进行调试安装。
- 2、本产品不能防水，需避免日晒雨淋，如安装在户外，请用防水箱。
- 3、良好的散热条件会延长产品的使用寿命，请把产品安装在通风良好的环境。
- 4、请检查使用的LED电源输出电压电流，是否符合产品要求。
- 5、出于安全考虑，推荐输入和输出（信号端除外）用0.75-1.5mm² PVC或橡胶线缆，并确保接线牢固，以免电线过热或接触不良触发事故。扁平电源线不适用。
- 6、通电调试前，应确保所有接线正确，以避免因接线错误而导致灯具损坏。
- 7、如果发生故障，请勿私自维修；如果有疑问，请联系供应商。

※ 本说明书内容如有更新，恕不另行通知。若您使用的产品功能与说明书不一致时，请以产品为准。如有疑问请与我们联系。