



LED Down light: DLC0860-B

Product Description

DLC0860-B are originally researched and developed pure aluminum heat sink, the general design requirements with two reflector cups, two times optical principle, frost glass diffuser, first optics to use PC reflector, reflective rate>95% , second optics to use 1090 reflector, top quality CITIZEN LEDs, with high quality exterior driver, dimmable, good heat sink, brilliant quality, more than 40,000 hours life span.

Technical Parameter

Nominal wattage	60W
Input Voltage	100-240V/220-240V 50/60Hz
Color temperature	3000k/4000k/5000k
Color rendering index	Ra>80
Beam angle	25°/45°/55°
3000k Luminous flux	25° 5690lm/45° 5320lm/55° 5310lm
4000k Luminous flux	25° 6210lm/45° 5600lm/55° 5580lm
5000k Luminous flux	25° 5990lm/45° 5830lm/55° 5920lm
Product color	Silver face/White face/Black face
Dimming	No Dim/Triac Dim/1-10V Dim
Cut out diameter	∅ 210-220mm
Type of protection	IP20
Protection class	III
Operation temperature	-20℃-50℃
Warranty	5years

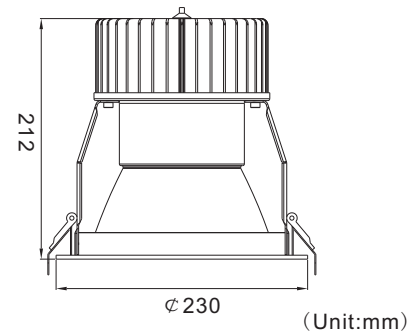

Ordering Information

Example:DLC0860-B830T-W-25°

DLC	08	60	B	8	30	T	W	25°
Type	Product Size	Wattage	Series	CRI	CCT	Dimming	Product Color	Beam Angle
DLC DLC series Down light	08 8 inch	22 22W 28 28W 38 38W 50 50W 60 60W 70 70W	A A Series B B Series	8 >80 9 >90	30 3000K 40 4000K 50 5000K	F No Dim T Triac Dim A 1-10v Dim	S Silver B Black W White	25° 45° 55°

more details please refer to our website www.kingwatt.com

LED Down light: DLC0860-B

Product features

- High brightness, Low SDCM < 3, low light decline
- High efficacy, high illuminance, accurate beam angle makes comfortable illumination atmosphere
- Refined components and design, guarantee a long life span of over 40,000 hours
- Exterior driver triac dimmable (200-240v input) and 1-10v Dimmable (100-240v input)
- Easy installation, for wide applications

Logistical Data

Product model	DLC0860-B	
Packaging unit	Folding carton box	Shipping carton box
Packaging Qty	1pcs	8pcs
Dimensions (Lx Wx H)	240×265×260mm	545×500×540mm
Volume	16.54dm ³	147.15dm ³
Gross weight	2.31kg	21.70kg

Test Data

DLC0860-B830

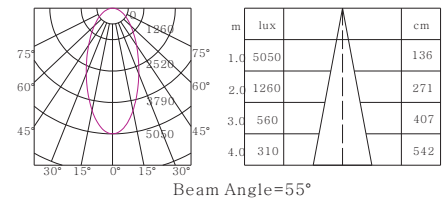
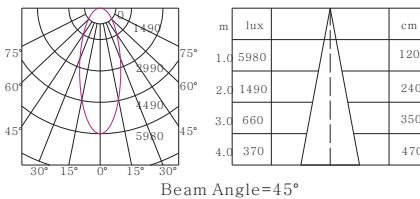
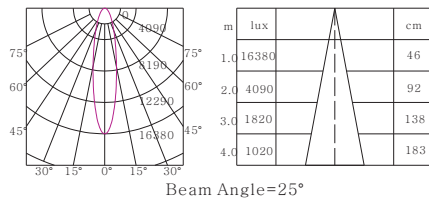

DLC0860-B840

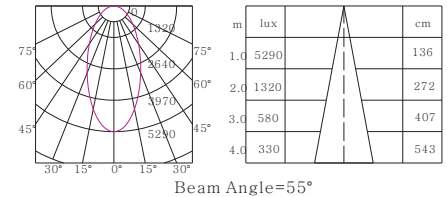
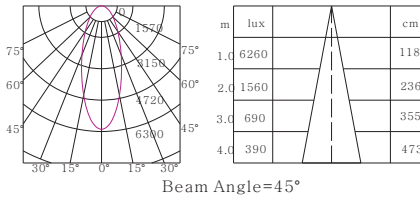
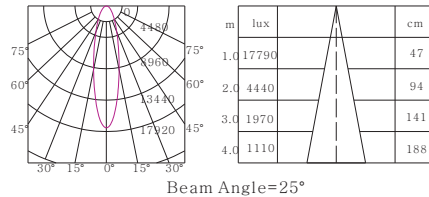

DLC0860-B850

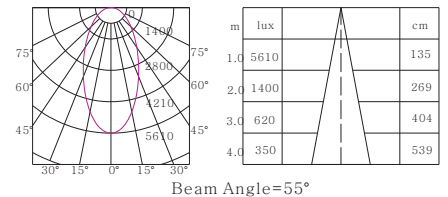
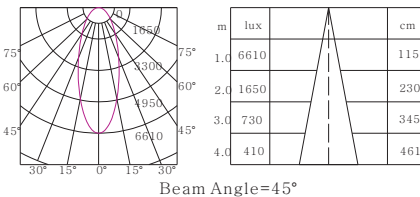
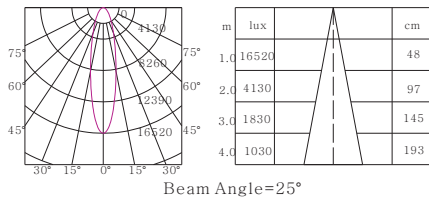

Installation

1. Open the hole in the ceiling (Picture one)
2. Connect the power lead with the terminal block of the led driver (Picture two)
3. As shown in the following figure, the lamps mounted in the mounting hole, and ensure string (Picture three)
4. Fix the safety rope on the ceiling (Picture four)

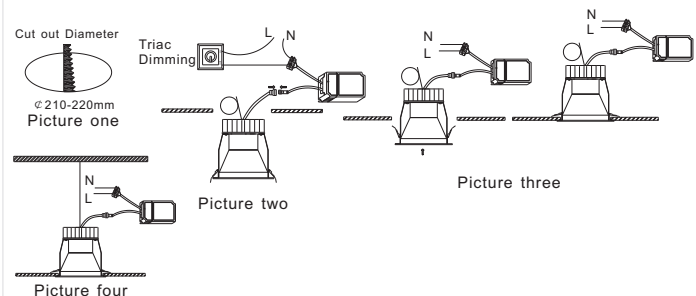

Disclaimer

Subject to change without notice, Errors and omission excepted. Always make sure to use the most recent release.