

Champion G2 3712 Flood Light



Key Features

- Fin-type heat sink, good heat dissipation to ensure long life span.
- High efficiency up to 150lm/W to save energy.
- Safe and durable tempered glass, woven tempered glass optional to reduce glaring.
- IP66 high protection grade.
- Power range from 10W-300W with various beam angle available, workable in different applications.

Applications



Sports

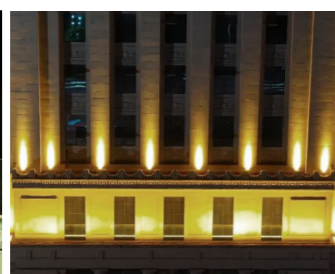

Buildings



Street

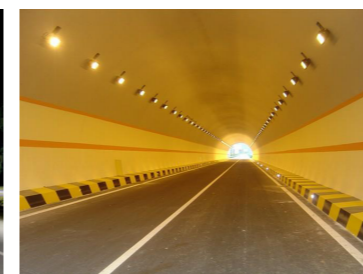

Others

Specifications

DOB Design (Woven tempered glass)					Driver version (Clear tempered glass)							
Model No.	3712-10W	3712-20W	3712-30W	3712-50W	Model No. (With Driver)	3712-70W	3712-100W	3712-150W	3712-200W	3712-240W	3712-300W	
Power	10W	20W	30W	50W	Power	70W	100W	150W	200W	240W	300W	
Product Dimension	113x73x32(mm)	142x92x32(mm)	190x121x32(mm)	196x188x34(mm)	Product Dimension	332x272x60(mm)	332x272x60(mm)	336x292x60(mm)	460x354x60(mm)	460x354x60(mm)	485x412x65(mm)	
Efficiency	110±10lm/W				Efficiency	140±10lm/W (30°/60°/90°/TYPE2/ TYPE3)						
Luminous Flux (±10%)	1100±100lm	2200±200lm	3300±300lm	5500±500lm	Luminous Flux (±10%)	9800±700lm	14000±1000lm	21000±1500lm	28000±2000lm	33600±2400lm	42000±3000lm	
LED Quantity	14 PCS SMD 2835	28 PCS SMD 2835	42 PCS SMD 2835	70 PCS SMD 2835	LED Quantity	24 PCS EMC 5050	36 PCS EMC 5050	48 PCS EMC 5050	90 PCS EMC 5050	90 PCS EMC 5050	110PCS EMC 5050	
CCT	3000K;4000K;5000K;6500K				High Efficiency	150±10lm/W (120°)						
Ingress Protection	IP66				Luminous Flux (±10%)	10500±700lm	15000±1000lm	22500±1500lm	30000±2000lm	36000±2400lm	45000±3000lm	
Color Rendering Index	Ra>80				LED Quantity	224 PCS SMD 2835	224 PCS SMD 2835	336 PCS SMD 2835	532 PCS SMD 2835	532 PCS SMD 2835	672 PCS SMD 2835	
Beam Angle	120°				CCT	3000K;4000K;5000K;6500K						
Driver Brand	TOMCARLINE				Ingress Protection	IP66						
Input Voltage	AC220-240V				Color Rendering Index	Ra>80						
Power Factor	0.95				Beam Angle	120°/30°/60°/90°/TYPE2/ TYPE3						
Frequency	47-63HZ				Driver Brand	TOMCARLINE						
Surge Protection	2KV/2KV				Input Voltage	AC120-277V						
Driver Type	DOB				Power Factor	0.95						
Luminaire Net Weight	0.2kg	0.3kg	0.5kg	0.9kg	Frequency	47-63HZ						
Packing Information	48pcs	26pcs	24pcs	16pcs	Surge Protection	6KV/10KV						
Export Carton Size	43.6*26.9*24cm	44.6*31.9*13.5cm	43.6*31.1*21.6cm	41.4*31.1*23.6cm	Driver Type	Constant Current (CC)						
Gross Weight	12.7kg	8.8kg	15.2kg	15.5kg	Luminaire Net Weight	2.5kg	2.5kg	3.6kg	5.7kg	5.7kg	7.7kg	
Material	Housing	Aluminum alloy				Packing Information	1pcs	1pcs	1pcs	1pcs	1pcs	1pcs
	Optics	Woven tempered glass				Export Carton Size	36.8*31*13cm	36.8*31*13cm	38.6*33.7*13cm	49.5*39.2*13cm	49.5*39.2*13cm	52.2*44.8*13.5cm
Finish	Powder coating				Gross Weight	2.9kg	2.9kg	4.1kg	6.3kg	6.3kg	8.4kg	
Fixture Color	Black				Material	Housing	Aluminum alloy					
Mounting Option	Wall mounting / Slip fitter pole installation					Optics	Clear tempered glass/ Clear tempered glass+PC lens					
Storage temperature range	-30℃ - +70℃				Finish	Powder coating						
Storage humidity range	85% max.				Fixture Color	Black						
Operating temperature range	-40~+45℃				Mounting Option	Wall mounting / Slip fitter pole installation						
Operating humidity range	85% max.				Storage temperature range	-30℃ - +70℃						
Life Time	50.000 hours				Storage humidity range	85% max.						
Warranty	3 Years				Operating temperature range	-40~+45℃						
					Operating humidity range	85% max.						
					Life Time	50.000 hours						
					Warranty	5 Years						
					Dimmable	1-10V Dimmable, DALI Dimmbale						
						1-10V/DALI driver						
						Woven tempered glass (MOQ200pcs)						
					Optional Accessories	Motion sensor&Daylight sensor						
						Slip fitter for street light or billboard lighting (60/42mm or 76mm)						
						10KV/20KV SPD						
						Metal breathing valve						

Certifications



Light Distribution Curve

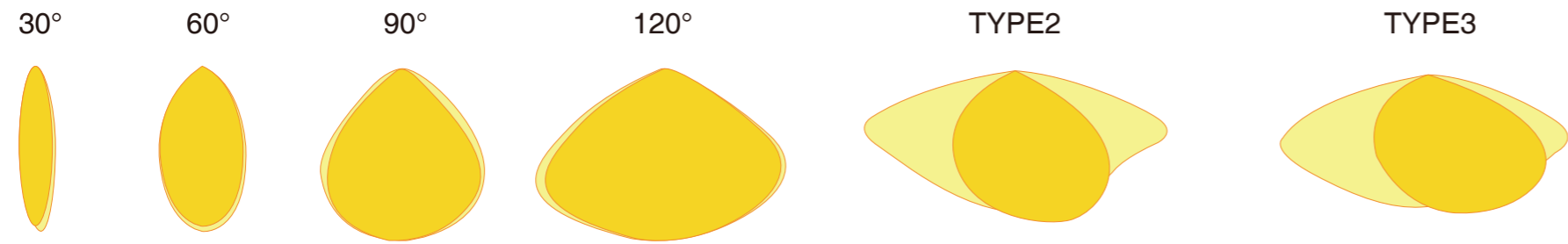

Optional Accessories



1-10V dimmable
DALI dimmable
(70W-300W)



Motion sensor
& Daylight sensor
(Two-in-one sensor)
70W-300W

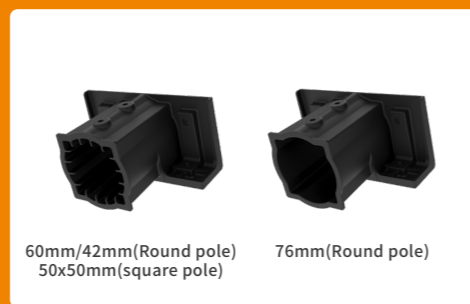

Slip fitter for street light or
billboard lighting
(60/42mm or 76mm)
70W-300W



10/20KV SPD
(70W-300W)



Metal breathing valve
(Standard PC)
50W-300W

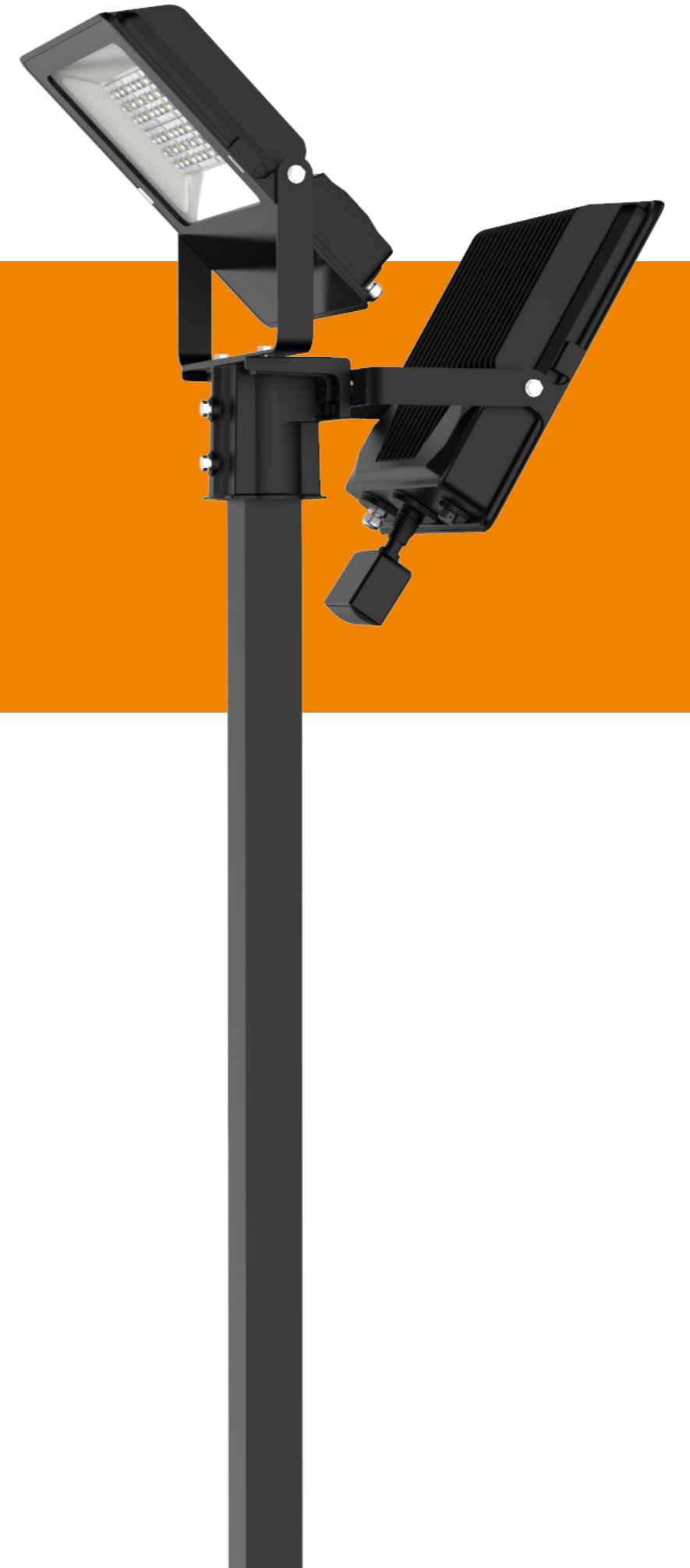

Dimensions

3712-10W

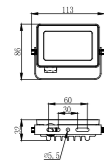

3712-20W

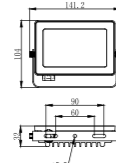

3712-30W

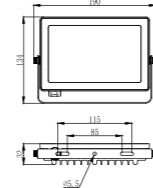

3712-50W

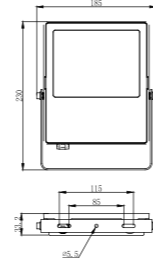

70W/100W

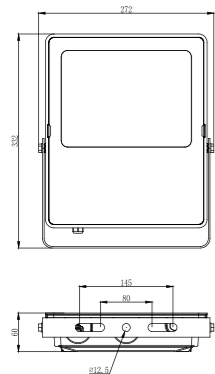

3712-150W

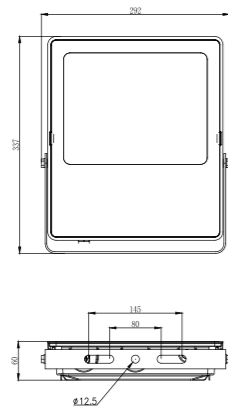

3712-200W/240W

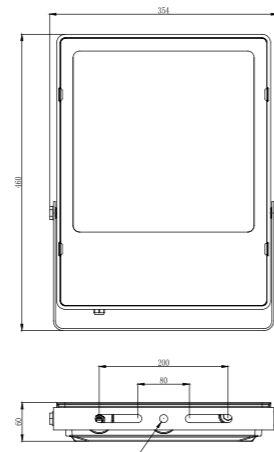

3712-300W

