



UP-CL94-8-35W

Introduction



new design anti-glare CL94 led downlight adopts Citizen COB chip collocating with deep reflection cup. This unique design skillfully prevent the human eyes contact with the light sources directly, makes the light more soft, UGR < 19. Meanwhile the light efficiency reach to 90lm/w with perfect accent lighting performance. That makes it become the priority selected product for commercial lighting. V shape cooling fins heat sink design increases the interface between heat sink and air, which makes the heat dissipating performance outstanding and extend the service life of the downlight. 3 size are optional: 3inch-13w, 6inch-25w, 8inch-35w. Two installation clips for each downlight makes installation easier.

- Up to 70% energy saving compared to standard CFL
- Long lifetime of 40,000 hours
- Triac dim, 0-10V dim, DALI dim
- 45°wide beam angle
- 205-220mm cutout
- CCT: 2700K 3000K
4000K 5000K
- No UV/IR light
- Environment friendly, without Mercury or any other hazardous substances

Application notes

- IP20 for indoor use only
- Professional electrician for installation only
- Switch off before installation
- Do not touch when in use
- Keep away from hot steam and corrosive gas

Application Areas

It is designed for general lighting applications in office, supermarket, shop, school, hotel, etc. It is also widely used for public areas, such as stairway, lobby, reception, corridors etc.

Certificate

CE RoHS SAA



Product Information

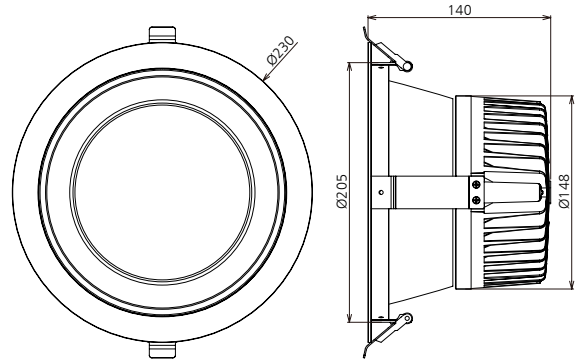

Technical Specifications

Model	Voltage	Power	Power Factor	Lumen (±5%)	Beam angle	CCT	Lifespan	CRI	Dimmable	Dimension
UP-CL94-8-35W	AC230V	35W	≥0.9	3100	45°	2700K	40000h	≥80	No	Ø230*140mm cutout 205-220mm
UP-CL94-8-35W	AC230V	35W	≥0.9	3200	45°	3000K	40000h	≥80	No	Ø230*140mm cutout 205-220mm
UP-CL94-8-35W	AC230V	35W	≥0.9	3350	45°	4000K	40000h	≥80	No	Ø230*140mm cutout 205-220mm
UP-CL94-8-35W	AC230V	35W	≥0.9	3300	45°	5000K	40000h	≥80	No	Ø230*140mm cutout 205-220mm
UP-CL94-8-35W-D	AC230V	35W	≥0.9	2900	45°	2700K	40000h	≥80	Yes	Ø230*140mm cutout 205-220mm
UP-CL94-8-35W-D	AC230V	35W	≥0.9	3050	45°	3000K	40000h	≥80	Yes	Ø230*140mm cutout 205-220mm
UP-CL94-8-35W-D	AC230V	35W	≥0.9	3150	45°	4000K	40000h	≥80	Yes	Ø230*140mm cutout 205-220mm
UP-CL94-8-35W-D	AC230V	35W	≥0.9	3200	45°	5000K	40000h	≥80	Yes	Ø230*140mm cutout 205-220mm

Driver data Sheet

Driver data	DIM	Non dim
Input rated Voltage	AC230V	AC230V
Frequency	50Hz	50Hz
Input Voltage	AC200-240V	AC200-240V
Efficiency	≥84%	≥86%
Total load Wattage	35W±5%	35W±5%
Power Factor	≥0.9	≥0.9
Rated input current	≤0.2A	≤0.2A
Full load output Voltage	DC23-40V	DC27-40V
Rated output current	800mA	800mA
Output current range	800mA±5%	800mA±5%
Power tolerance	±5%	±5%
Current output tolerance	±5%	±5%
Dimming range	8%-100%	—
Dimmer	Triac dimmers	—
Short circuit protection	PASS	PASS
Over voltage protection	PASS	PASS
Over temperature protection	PASS	PASS
THD	≤18%	≤18%
Withstand voltage	AC3750V	AC3750V

Fixture Compatibility

Rated Wattage	Electrical Classification	Ingress Protection	Operating Temp	Operating Humidity	Storage Temp
35W	II	IP20	-20°C~45°C	0~90%	-20°C~65°C

Spectral Distribution

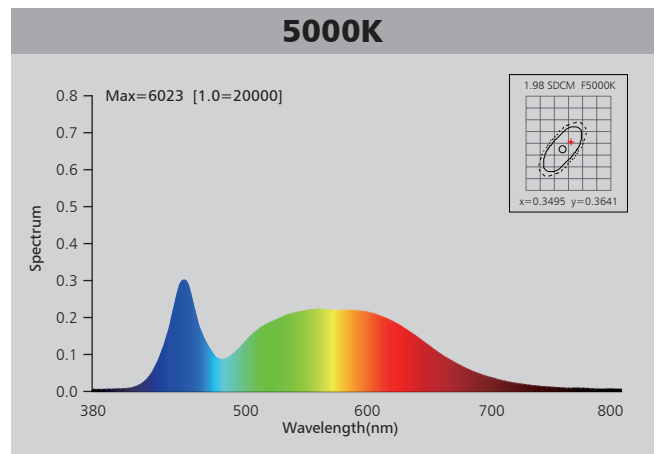
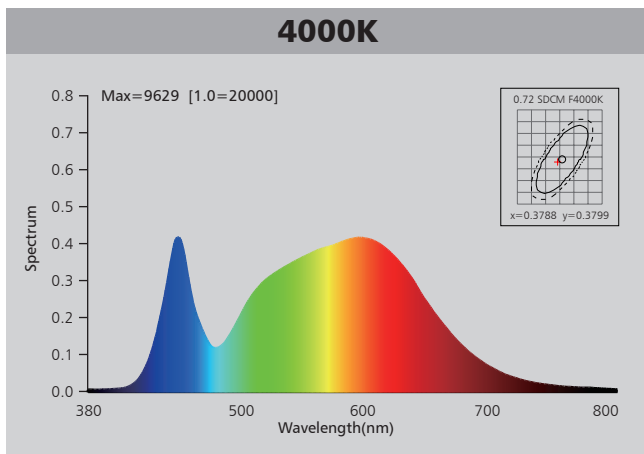
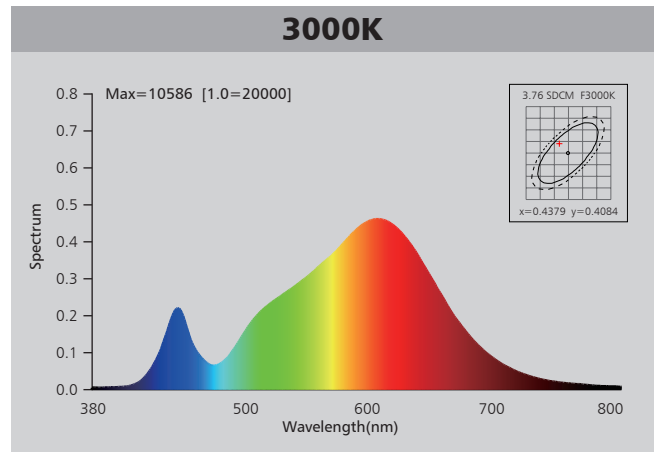
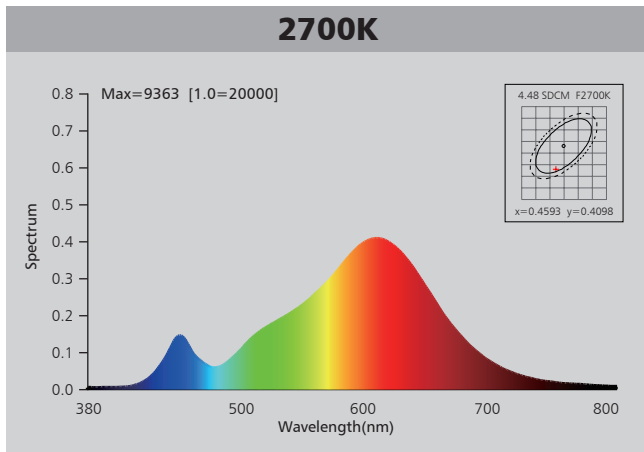

Photometric Diagram

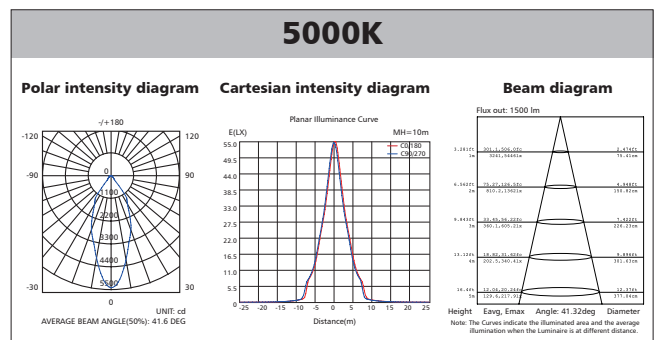
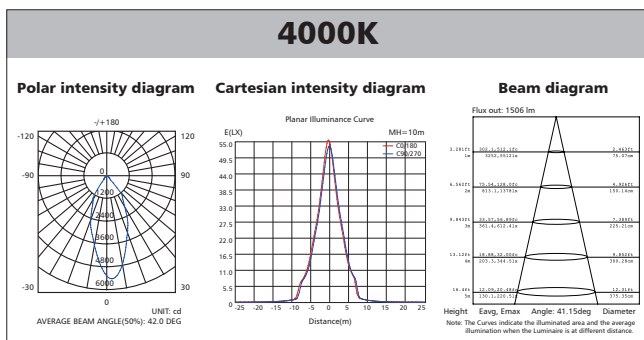
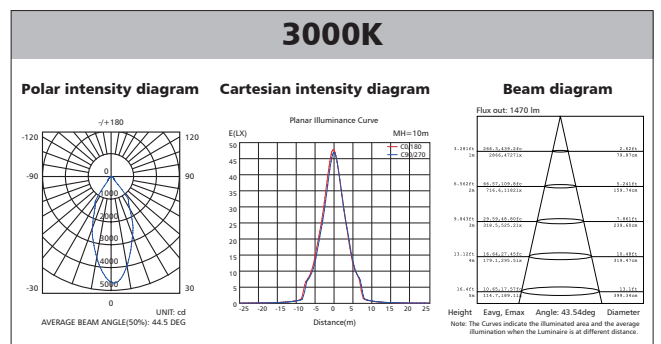
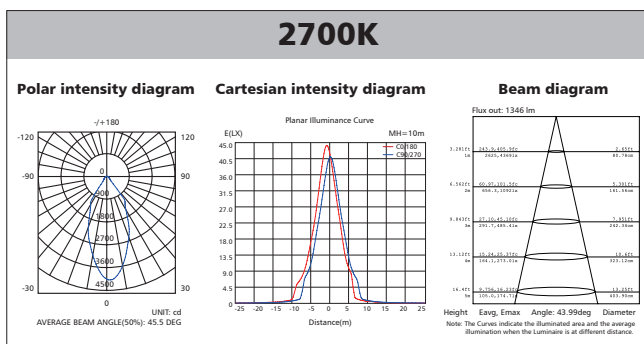

Polar Diagram Comparison

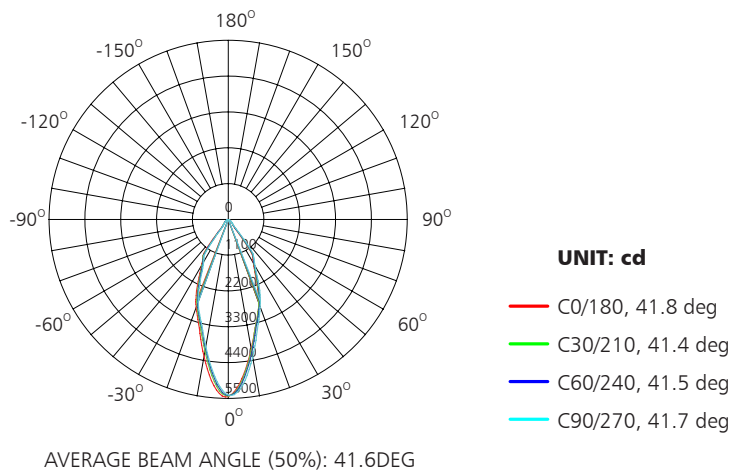

Driver lifetime & LED light decay rate

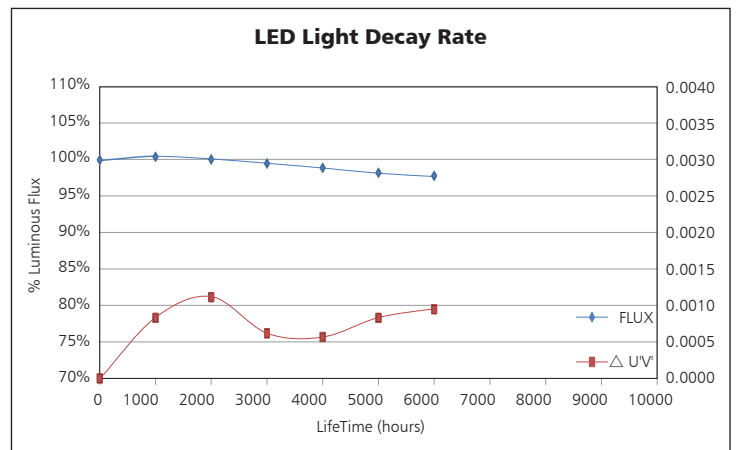
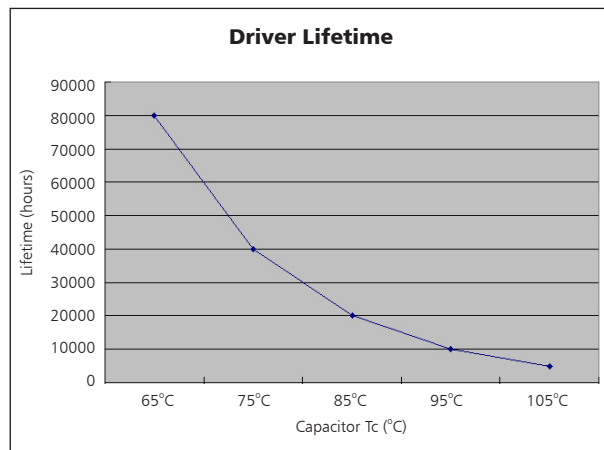

Temperature

- The testing is operated at 25°C
- The lifetime of capacitor, minimum of 5,000 hours if operated at 105°C, will be doubled whenever the temperature drops 10°C.
- The highest withstand temperature of IC, MOS could be 120°C
- The highest withstand temperature of LED junction temperature is 150°C

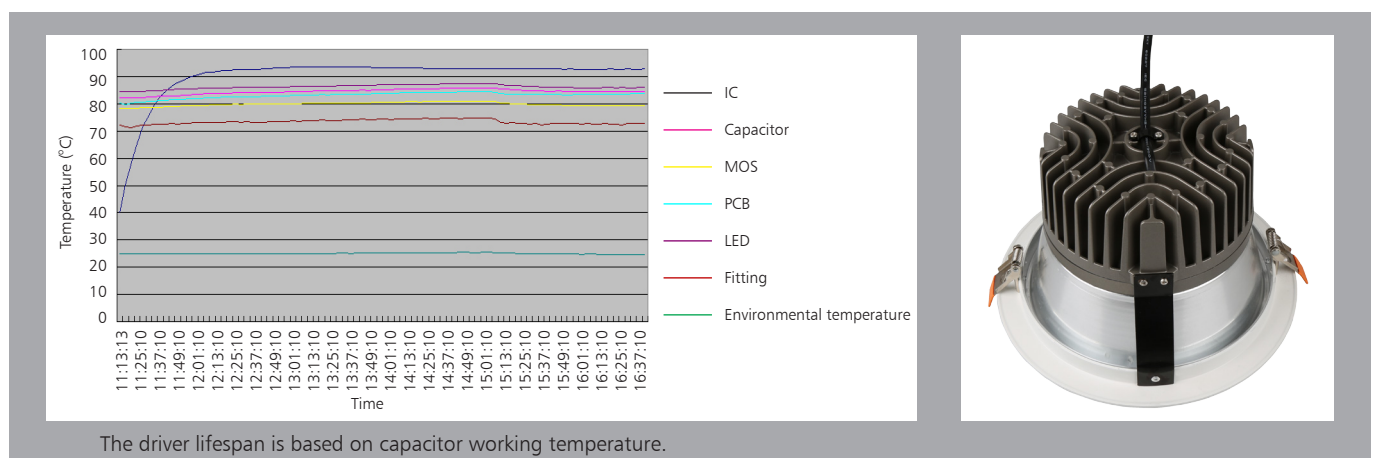

Installation

Install requirements	
A-gap above the fitting	25mm
B-gap to the building material	25mm
C-gap to the thermal insulation	25mm

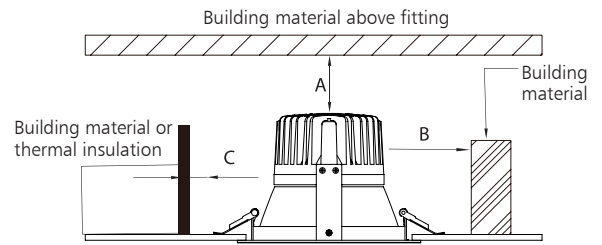

<p>Ceiling Opening</p> <p style="text-align: right;">1</p>	<p>Connect Power supply</p> <p style="text-align: right;">2</p>
<p>A. Hold back spring clips</p> <p>B. Push downlight into position</p> <p style="text-align: right;">3</p>	<p>Finish</p> <p style="text-align: right;">4</p>

Packaging Information

	SIZE(CM)	N.W/pc (KGS)	G.W.(KGS)	Q'TY(PCs)
Carton	53*53*52	1.2	17	12

	CTNS	Q'TY(PCs)	VOLUME(CBM)
20" standard container	190	2280	28
40" standard container	380	4560	56

