



Essential SmartBright All-in-one Solar Streetlight

BRC010 LED20/765

Integrated solar street light with Lithium Ferro Phosphate battery, solar panel and charger built into the luminaire. Optional pole mounting bracket. Microwave based motion sensor for optimizing battery autonomy.

Warnings and Safety

- Factory set dimming profile along with microwave sensor for run time maximization

Product data

General information	
Driver included	Yes
Optical cover/lens type	Reflector
Control interface	IR remote
Warranty period	1 years
Material	Acrylonitrile-butadiene-styrene

Operating and electrical	
Battery type	Lithium Ferro Phosphate
Battery ampere hour	8 Ah
Battery voltage	3.2 V
Panel type	Poly crystalline
Panel voltage	4.5 V
Panel peak wattage	8 W
Charge controller type	PWM

Controls and dimming	
Dimmable	Yes
Configurability	Configurable

Mechanical and housing	
Overall length	485 mm
Overall width	230 mm
Overall height	54 mm

Approval and application	
Ingress protection code	IP65 [Dust penetration-protected, jet-proof]

Initial performance (IEC compliant)	
Initial luminous flux (system flux)	2000 lm
Initial LED luminaire efficacy	130 lm/W
Init. Corr. Color Temperature	6500 K

Essential SmartBright All-in-one Solar Streetlight

Init. Color Rendering Index	>70
-----------------------------	-----

Application conditions

Ambient temperature range	0 to +45 °C
Solar dimming profile	As per remote controller
Battery location	Inside luminaire

Product data

Full product code	692382864898599
Order product name	BRC010 LED20/765

EAN/UPC - Product	6923828648985
Order code	911401827602
Numerator - Quantity Per Pack	1
Numerator - Packs per outer box	5
Material Nr. (12NC)	911401827602
Net Weight (Piece)	1.750 kg

IP 65

Dimensional drawing

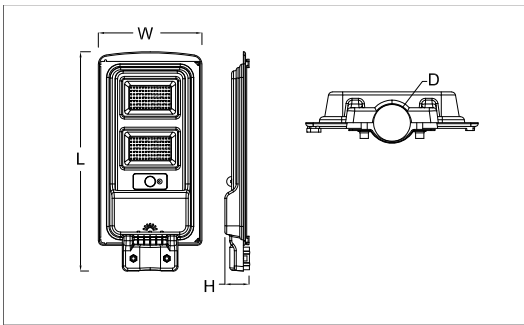

BRC010 LED20/765

