



Essential SmartBright All-in-one Solar Streetlight

BRC010 LED10/765

Integrated solar street light with Lithium Ferro Phosphate battery, solar panel and charger built into the luminaire. Optional pole mounting bracket. Microwave based motion sensor for optimizing battery autonomy.

Warnings and Safety

- Factory set dimming profile along with microwave sensor for run time maximization

Product data

General information	
Driver included	Yes
Optical cover/lens type	Reflector
Control interface	IR remote
Warranty period	1 years
Material	Acrylonitrile-butadiene-styrene

Operating and electrical	
Battery type	Lithium Ferro Phosphate
Battery ampere hour	5 Ah
Battery voltage	3.2 V
Panel type	Poly crystalline
Panel voltage	4.5 V
Panel peak wattage	6 W
Charge controller type	PWM

Controls and dimming	
Dimmable	Yes
Configurability	Configurable

Mechanical and housing	
Overall length	395 mm
Overall width	205 mm
Overall height	52 mm

Approval and application	
Ingress protection code	IP65 [Dust penetration-protected, jet-proof]

Initial performance (IEC compliant)	
Initial luminous flux (system flux)	1000 lm
Initial LED luminaire efficacy	135 lm/W
Init. Corr. Color Temperature	6500 K

Essential SmartBright All-in-one Solar Streetlight

Init. Color Rendering Index	>70
-----------------------------	-----

Application conditions

Ambient temperature range	0 to +45 °C
Solar dimming profile	As per remote controller
Battery location	Inside luminaire

Product data

Full product code	692382864897899
Order product name	BRC010 LED10/765

EAN/UPC - Product	6923828648978
Order code	911401827502
Numerator - Quantity Per Pack	1
Numerator - Packs per outer box	5
Material Nr. (12NC)	911401827502
Net Weight (Piece)	1.200 kg

IP 65

Dimensional drawing

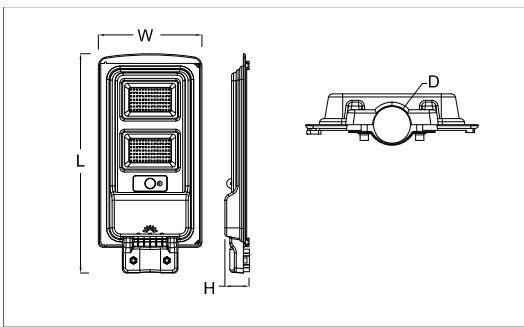

BRC010 LED10/765

