

technical hotline +44 (0)1268 563720

white | wiring devices

## Switchsocket Outlets

### Standards and approvals

Logic Plus™ 13A socket outlets comply with BS 1363: Part 2: 1995.

Replacement fuses to the 3 gang socket outlets comply with BS 1362: 1973.

### Technical specification

#### Electrical

Voltage rating:  
250V a.c.

Current rating:  
13A per socket outlet  
(except 3 gang which is 13 amp in total)

Terminal capacity:  
Live, neutral & earth  
3 x 2.5mm<sup>2</sup>  
3 x 4mm<sup>2</sup>  
2 x 6mm<sup>2</sup> (standard)  
(Dual earth terminals on list Nos.  
K781, K2657, K2737, K2746, K2757)

#### Physical

Ambient operating temperature:  
-5°C to +40°C  
(not to exceed an average of more than 25°C in any 24 hour period)

IP rating:  
IP2XD

Max. installation altitude:  
2000 metres

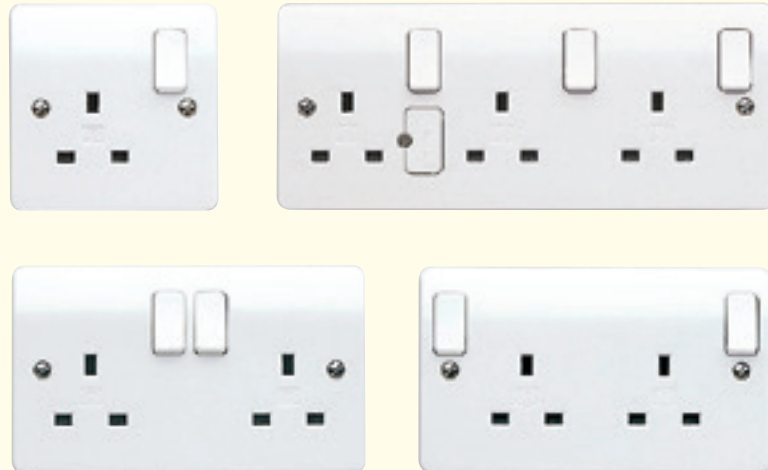

### Description

A range of socket outlets designed for ease of installation and having all the advantageous design features of the Logic Plus™ range. The 2 gang sockets with outboard rockers are of particular value for use by the infirm and partially sighted.

Non-standard clean earth sockets are for use on installations where restricted access is required and will only accept a 647WHI 13A non-standard plug with T-shaped earth pin. The sockets have two independent earth terminals so that they can also be used for 'clean earth' installations. K2746CE and K2947CE also have two independent earth terminals for 'clean earth' installations.

A variety of sockets (see Technical specification) are fitted with two earth terminals on a common busbar to provide a double earth facility for use when installations require a high integrity protective connection as specified within BS 7671: 2008.

The products can be quickly installed as replacement for existing 13 amp sockets or in a new installation.

#### Fuse carriers

##### (3 gang switchsocket only)

The fuse carrier is opened by a fast-acting, screwdriver-operated, worm-drive screw for ease of replacement.

#### Round pin sockets

A range of round pin sockets is also available, switched and unswitched.

BOX TYPES				
	Flush	Flush (for extra wiring space)	Surface Insulated	Surface Metal
1 gang	861ZIC	866ZIC	K2140WHI	K2211ALM/K2213ALM
2 gang	862ZIC	886ZIC	K2142WHI	K2212ALM/K2214ALM
3 gang	K863ZIC	Not available	K2153WHI	Not available

For a full range of corresponding products, see pages 42-60 in the product selector.

## Switchsocket Outlets

### Features

- Moulded 'on' indicator flash on switches will not rub off – totally safe
- Optional neon indicators in the switch rockers with 175° visibility in the horizontal and vertical planes
- 3 pin operated safety shutter
- Printed terminal markings on grey rear mouldings for clearer identification
- Top access, angled terminals make wiring easier and quicker
- 3mm minimum switch contact gap
- Double pole switching
- Choice of inboard or outboard positioned rockers
- Additional electrical safety from neutral 'make first', 'break last' feature
- Switch contacts with silver contacts on both surfaces for good continuity
- Only one size of screwdriver required for installation
- Selection of products incorporating dual earth terminals for high integrity earthing
- Backed out and captive terminal screws
- 'Clean earth' sockets available
- Non-standard 'clean earth' sockets available
- Selected sockets available in graphite finish to assist with Part M compliance

### Installation

Logic Plus™ socket outlets can be wall or bench mounted. Do not mount or use as a trailing socket or where they may be subject to excessive moisture or dampness.

#### 1 gang switchsocket – view from rear

Top-facing, angled, backed-out terminals make wiring easier and quicker.



### Dimensions (mm)

#### 1 gang

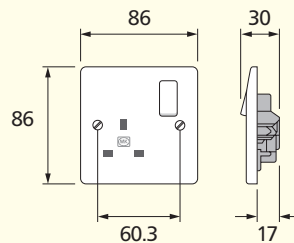

#### 2 gang

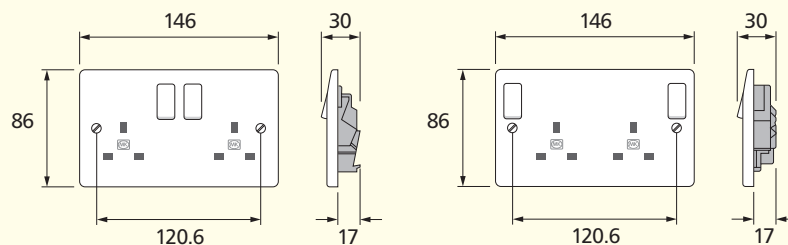

#### 3 gang

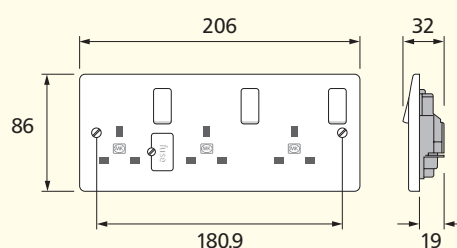

### Cable management

Logic Plus™ socket outlets can be mounted in a variety of MK trunking systems.

## Sentrysocket RCD Protected Switchsocket Outlet

### Compliance with EC Directives, Standards and approvals

Sentrysockets comply with the following EC Directives and are CE marked:

Low Voltage Directive  
Electromagnetic Compatibility Directive (89/336/EEC)

Sentrysocket RCD Single Sockets also comply with the requirements of the following standards:

BS 7288: 1990

BS EN 50082-1: 1998

Sentrysocket RCD Double Sockets comply with BS EN 61543: 1996 and BS EN 55014-1



### Description

Sentrysocket provides a high level of protection against electrocution and gives further protection when used with appliances vulnerable to insulation damage, particularly when they are in damp environments or outdoors. Sentrysocket is not suitable for mounting in damp environments or outdoors.

Sentrysocket, incorporating an RCD, is part of a complete range of fixed and portable wiring devices and circuit protection devices suitable for use in domestic, commercial and industrial applications.

### Active control circuits

Incorporate a 'Re-set' mechanism and are mains failure sensitive, ie they will function under all the normal conditions expected of an RCD, but will also trip in the event of a power cut or a sudden, dramatic reduction in mains voltage. This makes them ideal for use where it would be hazardous for equipment to suddenly energise after return of mains power, such as use with rotating machinery and heat developing apparatus.

### Passive control circuits

Incorporate a 'Stay-set' mechanism and is mains failure proof, ie it will function under all the normal conditions expected of an RCD and will not trip in the event of a power cut. This makes it suitable for use with freezers or in inaccessible or unmanned locations.

### Technical specification

#### Electrical

Rated Voltage:  
240V a.c., 50 or 60Hz

Current rating:  
13A resistive

Rated tripping current  
30mA and 10mA versions

Terminal capacity:  
3 x 4mm<sup>2</sup> for 1 gang  
2 x 4mm<sup>2</sup> for 2 gang

#### Physical

Ambient operating temperature:  
-5°C to +40°C

IP rating:  
IP2XD

Max. installation altitude:  
2000 metres

Sentrysockets are only suitable for use in TN-S system where the Supply Neutral Connection is connected to the Supply Earth.

They are not suitable for connection across two lines of a 127V line to Neutral Voltage System.

### Features

- Suitable for most residential, commercial and light industrial applications
- Active and passive control circuit applications
- Comply fully with current Wiring Regulations
- Double pole switching
- Flexible and versatile in use
- Ideal for use with equipment subject to wet weather or high humidity
- Part of a complete range of MK circuit protection devices
- They are a.c. and pulsating DC sensitive for residual current

### Installation

Logic Plus™ RCD protected switch socket outlets can be wall or bench mounted. Do not mount or use as a trailing socket or where they may be subject to excessive moisture or dampness.

#### Flush mounting steel wall box

It should be noted that some of the conduit entries may be restricted, depending upon their positions and the depth of box used.

#### Cable management

Sentrysockets can be mounted in a variety of MK trunking systems.

### Dimensions (mm)

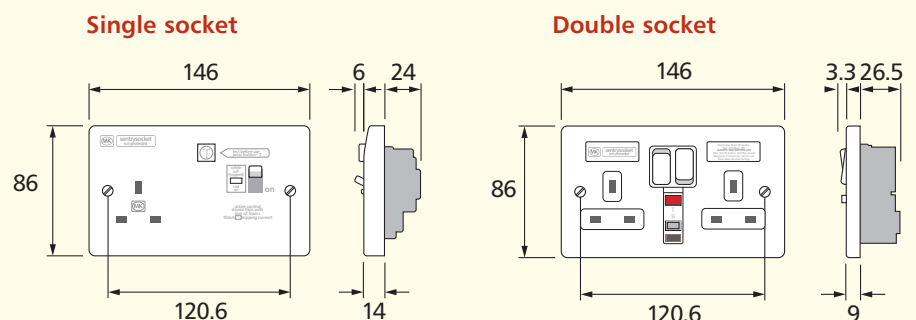

## Sentrysocket

### Installation

#### Flush mounting steel wall box

It should be noted that some of the conduit entries may be restricted, depending upon their positions and the depth of box used.

### Socket Testing:

#### Single Socket Testing

After installation, turn the mains electricity supply on.

To test that the Sentrysocket is functioning correctly:

1. Ensure that no appliance is connected to the Sentrysocket. **Switch Sentrysocket on:** The switch should remain closed and the red flag will appear in the window. If the switch fails to remain closed, check that the Supply L and N connections are not reversed or the Supply N connection is not open circuit. If the Sentrysocket is correctly connected and still trips after being switched on, the Sentrysocket is faulty and should not be used.
2. If the Sentrysocket stays on, **press the test button:** The switch will open and the white flag will appear in the window. If the Sentrysocket does not trip and there is mains voltage present at the socket outlet, Sentrysocket is faulty and should not be used.
3. **Switch Sentrysocket on:** Connect an RCD tester and ensure that the Sentrysocket trips within the specified time:
  - ≤ 200 ms AT RATED TRIP CURRENT
  - ≤ 40 ms AT 5 x RATED TRIP CURRENT
 If the Sentrysocket does not trip within the specified times then the product is faulty and should not be used (If more than one RCD is in series then there is no guarantee as to which device will trip first).
4. **Reset all tripped RCD's including the Sentrysocket.**
5. **Switch off the mains supply switch disconnecter.** On mains failure, a Sentrysocket with Active Control Circuit will trip, whilst a Sentrysocket with Passive Control Circuit will not trip. If the Active Control device does not trip, it is faulty and should not be used – see note below. If no faults have been found then installation testing has been completed successfully.

**Note:** If a fault is identified at any stage of installation testing procedure do not use Sentrysocket, and contact your local electrician, or your local MK stockist.

#### Double Socket Testing

After installation, turn the mains electricity supply on.

To test that the Sentrysocket is functioning correctly follow the steps 1 to 4 below:

1. Ensure that no appliance is connected to the Sentrysocket.
2. **Reset** – Press the button marked R (for Reset) – the contact status indicator should show red, indicating that the socket outlets are now live (if the switches are in the ON positions).
3. **Test** – Press the TEST button marked T (for Test), the product should trip with the contact status indicator showing black. In this state the socket outlets are disconnected from the supply.
4. **Reset** – Press the button marked R again, the contact status indicator should show red.
5. Connect an RCD Tester to either socket outlet and ensure that the Sentrysocket trips with the specified times below:
  - ≤ 200 ms AT RATED TRIP CURRENT
  - ≤ 40 ms AT 5 x RATED TRIP CURRENT
6. Reset the Sentrysocket as in step 2 above.
7. Switch off the Mains Supply Switch Disconnecter.
8. A Sentrysocket with Active Control Circuit should trip while a Sentrysocket with Passive Control Circuit should not trip.

If all the operations in steps 2 to 8 above give correct results, the Sentrysocket RCD socket outlet is safe to use.

**If the procedures in steps 2 to 8 above are not completed correctly, do not use the Sentrysocket product and seek professional advice or contact the MK Technical Sales and Service department on +44 (0)1268 563720.**

## Filtered Switchsocket Outlets

### Standards and approvals

Logic Plus™ Filtered Switch Socket Outlets comply with BS 5733: 2010.

### Technical specification

#### Electrical

Current rating:  
13A maximum total for 2 sockets

Voltage rating:  
250V a.c. 50Hz

Earth leakage:  
0.5 mA

Suppression:  
150 kHz – 30 MHz (transients)

Maximum energy absorption:  
140 Joules L – N  
140 Joules L – E

Terminal capacity:  
K1826 and K1816, 2 x 6mm<sup>2</sup>  
3 x 4mm<sup>2</sup>, 3 x 2.5mm<sup>2</sup>, 3 x 1.5mm<sup>2</sup>

#### Physical

Operating temperature:  
–5°C to +40°C (not to exceed an average of more than 25°C in any 24 hour period)

Thermal overload:  
The K1826 filter socket incorporates a thermal overload device in the RFI filter section. Overload current causes temperature rise, resulting in automatic 'trip out'. The overload device will re-set as the temperature falls.

IP rating:  
IP2XD

Max. installation altitude:  
2000 metres



### Description

A range of sockets in the Logic Plus™ style, designed to combat interference to or data losses on sensitive electrical products and systems due to mains borne voltage spikes and RFI.

Such systems include:

- Computer or microprocessor based equipment
- Telecommunications systems
- Electronic measurement equipment
- Cash registers
- Audio visual and hi-fi equipment

These products can be quickly installed as replacements for existing twin 13 amp sockets or in a new installation.

Two earth terminals on each product provide a double earth facility for use when installations require a high integrity protective connection as specified within BS 7671: 2008.

### Filter cassettes

Filter cassettes are supplied with sockets and have an LED which shows green under normal conditions but will turn red or extinguish when a replacement cassette (K1800) is required. An alarm will also beep at 5 second intervals to indicate replacement necessity. It can be de-activated if required.

### Cable management

Logic Plus™ socket outlets can be mounted in a variety of MK trunking systems.

### Dimensions (mm)

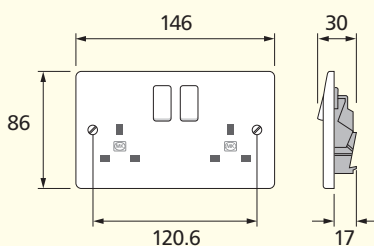

### Features

- Moulded 'on' indicator flash on switches will not rub off – totally safe
- 3 pin operated safety shutter
- Printed terminal markings on grey rear mouldings for clearer identification
- Reduces risk of damage to equipment and down time
- Reduces risk of data loss
- 2 way filtering – into appliance and back into mains supply
- Double pole switches
- Dual earth terminals for high integrity earthing
- Clearly visible LED on filter cassette, changes from green to red when replacement required
- Simple replacement of cassettes
- 10 year guarantee (except filter cassette)
- 3mm minimum switch contact gap
- Backed out and captive terminal screws

## Filtered Switchsocket Outlets

### Product features

Ensure that the connecting pins protruding from the bottom of the replacement Filter Cassette are not damaged or bent before installation. If in doubt, contact MK Technical Sales Service Department on +44 (0)1268 563720.

1. The MK Filtered Switchsocket, in common with many other filters uses Voltage Dependant Resistors for spike suppression purposes. The performance of these devices will eventually degrade with use to a level where they will no longer provide adequate protection.

When this occurs the spike filter performance of the MK Filtered Switchsocket outlet can be restored by replacing the filter cassette.

When the filter cassette needs replacing, the green indicator on the Replacement Filter Cassette will glow red or go out, an audible beep every five seconds may also be heard.

Note: As with all filters, these Filter Sockets will reduce the magnitude of RFI and spikes and consequently their ability to interfere with connected equipment. They will not completely remove the interference from the supply.

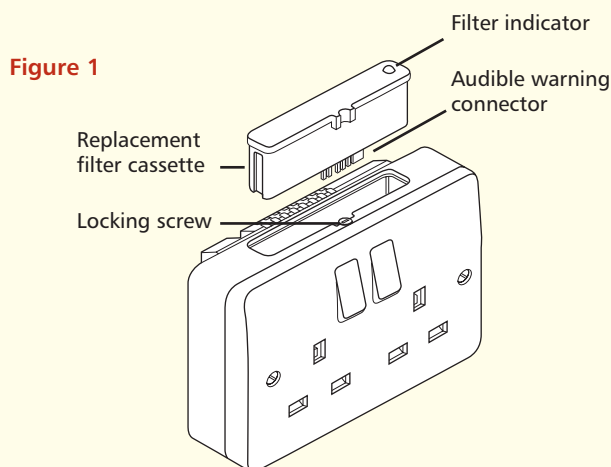

### Installation

#### Replaceable Spike Filter Cassette

**Note:** To ensure a safe installation;

- this product should be installed by a competent person.
- it is important that all connections are made as instructed.

1. The filter cassette can be removed and replaced without switching off the mains or removing any plugs from the filter socket.
2. Remove the filter cassette by turning the jacking screw anti-clockwise to partially eject it (see Figure 2), and then gently pulling the cassette upwards, (see Figure 2a).
3. **Only fit the MK Replacement Filter Cassette (K1800WHI).**

Unpack the new filter cassette and check that the pins along the bottom edge are not bent or broken. If these pins are damaged, do not fit the replacement cassette. The audible sound indicating that the filter cassette needs replacing, is optional. It may be prevented by removing the small connector on the two end pins, (see Figure 2b), before fitting it into the socket.

Figure 2

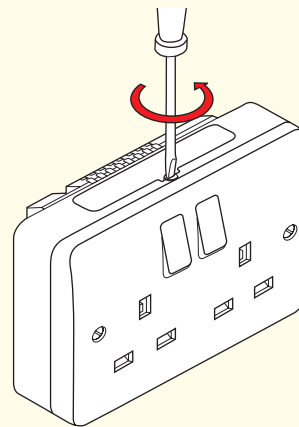

4. Fit the new filter cassette by carefully sliding it into the aperture and gently pushing it down while turning the screw clockwise until the filter cassette is flush with the surface. Do not turn the screw any further as this will cause distortion of the plastic mouldings.

Product and packaging can safely be disposed of via standard refuse facilities at the end of its useful life.

Figure 2a

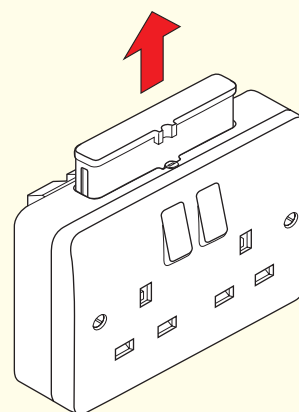
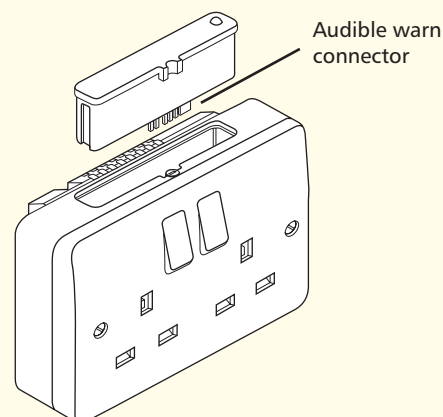

Figure 2b



## Round Pin Socket Outlets

### Standards and approvals

Round pin socket outlets comply with BS 546: 1950.

#### Technical specification

##### Electrical

Voltage rating:  
250V a.c.

Terminal capacities:

**2 amp sockets (K770):**

7 x 1mm<sup>2</sup>

4 x 1.5mm<sup>2</sup>

2 x 2.5mm<sup>2</sup>

1 x 4mm<sup>2</sup>

**5 amp sockets (K771, K2891):**

3 x 2.5mm<sup>2</sup>

2 x 4mm<sup>2</sup>

2 x 6mm<sup>2</sup> (stranded)

**15 amp sockets (K772, K2893, K2493):**

3 x 2.5mm<sup>2</sup>

3 x 4mm<sup>2</sup>

2 x 6mm<sup>2</sup> (stranded)

##### Physical

Ambient operating temperature:  
-5°C to +40°C

(not to exceed an average of more than 25°C in any 24 hour period)

IP rating:  
IP2XD

Max. installation altitude:  
2000 metres



### Description

A range of round pin socket outlets designed for ease of installation and having all the advantages and design features of the round pin Logic Plus™ range. These products can be quickly installed as replacements for existing socket outlets or in new installations.

#### Features

- Top access terminals make wiring easier and quicker
- Integral ON indicator on switches will not rub off – totally safe
- Optional neon indicator on 15A switched socket rockers with 175° visibility in the horizontal and vertical planes
- 3mm minimum switch contact gap
- Double pole switching
- Terminal screws backed out
- Additional electrical safety from neutral “make first”, “break last” feature on switched sockets
- Switch contacts with silver contact points on both surfaces for good continuity
- 5A and 15A sockets contain a 3 pin operated safety shutter
- Printed terminal markings on grey rear mouldings for clearer identification
- 2A socket shuttered

### Installation

Logic Plus™ socket outlets can be wall or bench mounted – do not mount or use as a trailing socket or where they may be subjected to excessive moisture or dampness.

### Cable management

Logic Plus™ socket outlets can be mounted in a variety of MK trunking systems.

### Dimensions (mm)

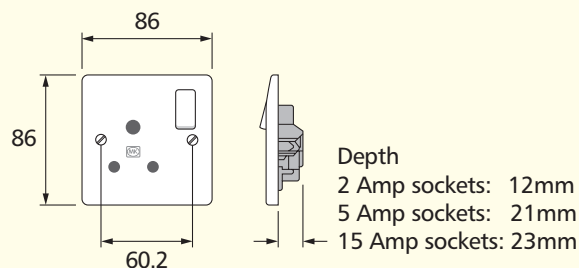

#### BOX TYPES

	Flush	Flush for extra wiring space	Surface Insulated	Surface Metal
5A and 15A	861ZIC	866ZIC	K2140WHI	K2211ALM K2213ALM
2A	3995ZIC	861ZIC 866ZIC	K2140WHI	K2211ALM K2213ALM

## Non UK Socket Outlets

### Standards and approvals

15A American sockets comply with SASO 2203: 2003

16A 2P+E German sockets comply with IEC 60884-1: 2006

### Technical specification

#### Electrical

##### 15A American Socket

Voltage rating:  
127V a.c.

Current rating:  
15A

Terminal capacity:  
Live, neutral & earth  
3 x 2.5mm<sup>2</sup>  
2 x 4mm<sup>2</sup>  
1 x 6mm<sup>2</sup> (stranded)

Max. installation altitude:  
2000 metres

##### 16A 2P+E German Socket

Voltage rating:  
250V a.c.

Current rating:  
16A

Terminal capacity:  
Live, neutral & earth  
4 x 1.5mm<sup>2</sup>  
2 x 2.5mm<sup>2</sup>  
1 x 4mm<sup>2</sup>

#### Physical

Ambient operating temperature:  
-5°C to +40°C  
(not to exceed an average of more than 25°C in any 24 hour period)

IP rating:  
IP2XD

Max. installation altitude:  
2000 metres

### 15A AMERICAN

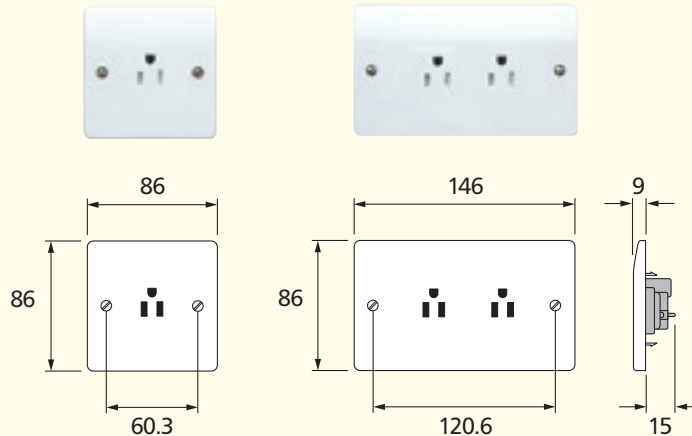

All dimensions  
in mm

#### BOX TYPES

	Flush	Flush (for extra wiring space)	Surface
1 gang	861ZIC	866ZIC	K2140WHI
2 gang	862ZIC	886ZIC	K2142WHI

### 16A 2P+E GERMAN

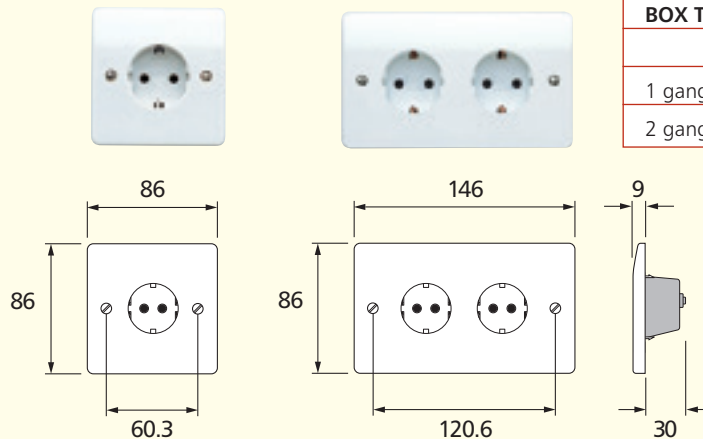

#### BOX TYPES

	Flush	Surface
1 gang	866 ZIC	K2031 WHI
2 gang	886 ZIC	K2172 WHI

**Note:**  
16A 2P+E German  
Outlet: These  
products are NOT  
suitable for 25mm  
deep boxes.

All dimensions  
in mm



## Three Pole Fan Isolators

### Standards and approvals

Comply with BS EN 60947: 1992

#### Technical specification

##### Electrical

Voltage rating:  
250V a.c. 50Hz

Current rating:  
10 amps

Terminal capacity:  
4 x 1mm<sup>2</sup>  
4 x 1.5mm<sup>2</sup>  
3 x 2.5mm<sup>2</sup>  
2 x 4mm<sup>2</sup>  
1 x 6mm<sup>2</sup>

Contact gap:  
4mm switch contact gap

##### Classifications

Method of operation: Stored energy operation  
Suitability for isolation: Suitable for isolation

##### Ratings

Utilisation category	AC23B
Rated operational voltage (Ue)	250V
Conventional free air thermal current (Ith)	10A
Rated frequency	50Hz
Rated making capacity	100A rms
Rated breaking capacity	80A rms
Rated conditional short-circuit current	6000A rms
(with supply side protective device GEC NIT 16 BS88: part 2: 1988 16A 550VAC utilisation category gG 80KA breaking capacity fuse links.)	

##### Physical

Operating temperature:  
-5°C to +40°C

IP rating:  
IP4X

Max. installation altitude:  
2000 metres



### Description

The MK Three Pole Fan Isolator provides a safe and simple method of isolating mechanical fan units and is particularly useful in bathrooms, toilets, storerooms and basements where there is little or no natural light.

For example, timer controlled fans are often linked into the lighting circuit for energy saving and convenience. In such an installation there is often a need for the lighting circuit to remain live to provide light whilst the fan unit is externally isolated so that routine maintenance and repairs can be carried out in complete safety.

The fan isolator can be used as a double pole or triple pole isolator. In addition it includes a clear on/off indicator and the frontplate features a fan isolator symbol for easy circuit identification.

### Dimensions (mm)

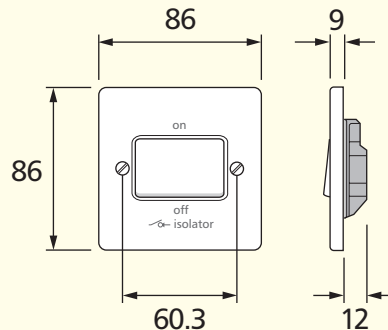

BOX TYPES	
Flush	Surface
3995ZIC	K2160WHI

### Features

- Switchlock list no. K4858 is available to allow the isolator to be locked in the disconnected position to facilitate fan maintenance

## Three Pole Fan Isolators

### Wiring diagrams

#### Two pole switching for fan units without timers

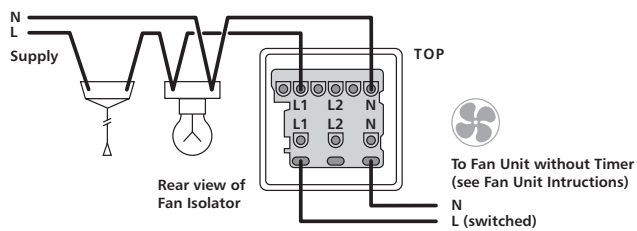
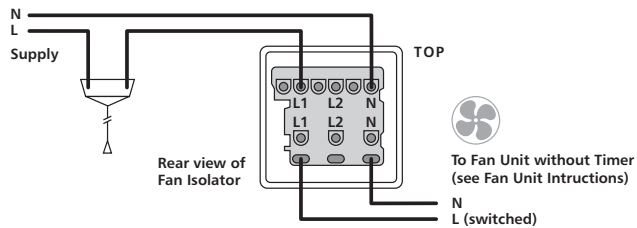

#### Three pole switching for fan units incorporating timers

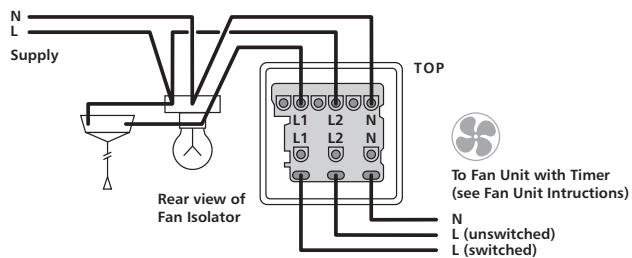
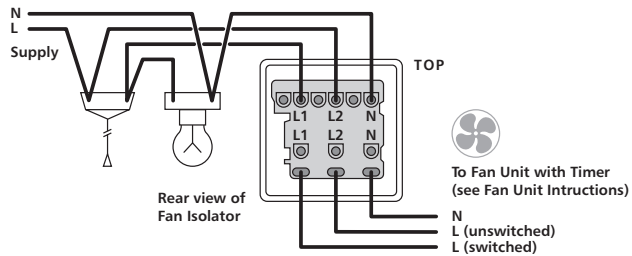

## Shaver Socket Outlets

### Standards and approvals

Shaver socket outlets comply with BS 4573: 1970 and IEC 884-1: 1994.

Plug pin apertures, and engagement face dimensions comply with BS 4573: 1970.

### Technical specification

#### Electrical

Voltage rating:  
200-250V a.c. Input

Maximum load:  
200 mA (internal thermister trip current)

Terminal capacities:  
Each terminal will accommodate 1 x 4mm<sup>2</sup>,  
or 2 x 2.5mm<sup>2</sup>, 3 x 1.5 solid conductors

#### Physical

Ambient operating temperature:  
-5°C to +40°C

IP rating:  
IP2XD

Max. installation altitude:  
2000 metres



### Description

Designed for ease of installation and having many of the advantageous features of the Logic Plus™ range.

The shaver socket outlet accommodates the following plugs:

British 5mm dia pins on 16.6mm pitch (230V socket) to BS 4573: 1970.

European 4mm dia pins on 17 to 19mm pitch (230V socket) to IEC 83: 1975 Standard C5.

Australian 6.5 x 1.6 flat blades each set at 30° to the vertical on a nominal pitch of 13.7mm (230V socket) AS C112: 1964.

The fuse carrier is captive and opened by a fast acting, screwdriver operated worm drive screw for ease of replacement.

### Installation

Shaver socket outlets may be wall or bench mounted.

This shaver socket **must not** be used in bathrooms and washrooms. Non-isolated, fused, shaver socket outlets must never be installed in any location subject to splashes, condensation or damp conditions.

For installation in any other room where a wash basin or shower cubicle is installed then refer to the current IEE wiring regulations.

### Cable management

Logic Plus™ socket outlets can be mounted in a variety of MK trunking systems.

### Features

- Top access terminals make wiring quicker and easier
- Only one size of screwdriver required for installation
- Terminal screws supplied 'backed out' and held captive within the terminal moulding
- Printed terminal markings on grey rear mouldings for clearer identification
- Front plate fixing screws retained on rear case moulding

### Dimensions (mm)

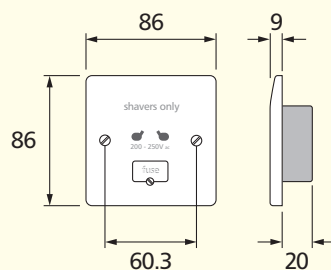

## Shaver/Toothbrush Supply Units

### Standards and approvals

Shaver/Toothbrush supply units comply with BS 61558-2-5: 1998

Accommodates plugs as follows:

- British 5mm dia pins on 16.6mm pitch (230V socket) to BS 4573: 1970.
- European 4mm dia pins on 17 to 19mm pitch (230V socket) to IEC 83: 1975 Standard C5.
- Australian 6.5 x 1.6 flat blades each set at 30° to the vertical on a nominal pitch of 13.7mm (230V socket) AS C112: 1964.
- American 6.6 x 1.6 flat horizontal blades on 12.7mm pitch (115V socket) to ANSI C73.10.

Note:

K706WHI is a Non UK Shaver/Toothbrush Supply Unit



### Technical specification

#### Electrical

Voltage rating:

K701: 230V a.c. Input (will operate at 220-250V a.c.)

K706: 127V a.c. Input (will operate at 110-130V a.c.)

230V or 115V nominal outputs

Current rating:

K701: 200mA max. (internal thermister trip current)

K706: 400mA max. (internal thermister trip current)

Maximum load:

20VA

No load voltage < 275V

Terminal capacities:

Each terminal will accommodate 1 x 4mm<sup>2</sup> or

2 x 2.5mm<sup>2</sup> solid conductors\*

#### Physical

Ambient operating temperature:

-5°C to +40°C

IP rating:

IP41 (In Zone 2 if fixed where direct spray from showers is unlikely)

Max. installation altitude:

2000 metres

\*The design of this unit means that on no load the transformer output is allowed to be as high as 275V. This means that rechargeable shavers and toothbrushes intended for use on the continent may be damaged by the inrush current created by this higher voltage. Rechargeable shavers and toothbrushes with a wide range of input voltage should be recharged at 115V. Shavers and toothbrushes manufactured for the UK are designed to be used with a transformer unit. Loads in excess of 20VA may cause the solid state overload to operate before shaving is completed. This is to protect the transformer.

### Description

Designed for ease of installation and having many of the advantageous design features of the Logic Plus™ range.

May be used in bathrooms and washrooms – must only be installed in accordance with BS 7671: 2008.

### Features

- Bottom access terminal screws make wiring quicker and easier
- Automatic primary supply switching on insertion of plug
- Choice of 230V or 115V output socket positions
- Safety interlocked shutters to prevent insertion of two plugs simultaneously
- Only one size of screwdriver required for installation
- Terminal screws supplied 'backed out' and held captive within the terminal moulding
- Printed terminal markings on grey rear mouldings for clearer identification
- Front plate fixing screws retained on rear case moulding
- Integral over current device to protect transformer
- Suitable for use with electric toothbrush chargers

### Installation

Shaver/Toothbrush supply unit should be wall mounted.

### Wiring

An installation instruction leaflet is available. List no. 44994 PL.

### Dimensions (mm)

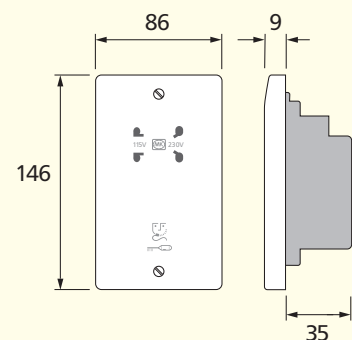

## Connection Units, 20A Switches and Flex Outlets

### Standards and approvals

All Logic Plus™ Connection Units comply with BS 1363: Part 4: 1995.

The 20A DP switch complies with BS EN 60669-1: 1999

The flex outlet plate complies with BS 5733: 2010.

Fuses are to BS 1362.

### Technical specification

#### Electrical

Voltage rating:  
250V a.c.

Current rating:  
Connection units – 13 amp  
DP switches – 20 amp  
Flex outlets – 20 amp

Terminal capacity:

Supply terminal: 2 x 6mm<sup>2</sup> stranded  
2 x 4mm<sup>2</sup>  
3 x 2.5mm<sup>2</sup>

Load terminals: 2 x 6mm<sup>2</sup> stranded  
2 x 4mm<sup>2</sup>  
3 x 2.5mm<sup>2</sup>

Flex outlet/  
Cord grip capacity:

Connection units: min: 2 core, 0.5mm  
max: 3 core, 1.5mm

20 amp DP  
switches & flex outlet plate  
min: 3 core, 1.5mm  
max: 3 core, 2.5mm

#### Physical

Ambient operating temperature:  
–5°C to +40°C  
(not to exceed an average of more than 25°C in any 24 hour period)

IP rating:  
With flex outlet: IP2XD  
Without flex outlet: IP4X

Max. installation altitude:  
2000 metres

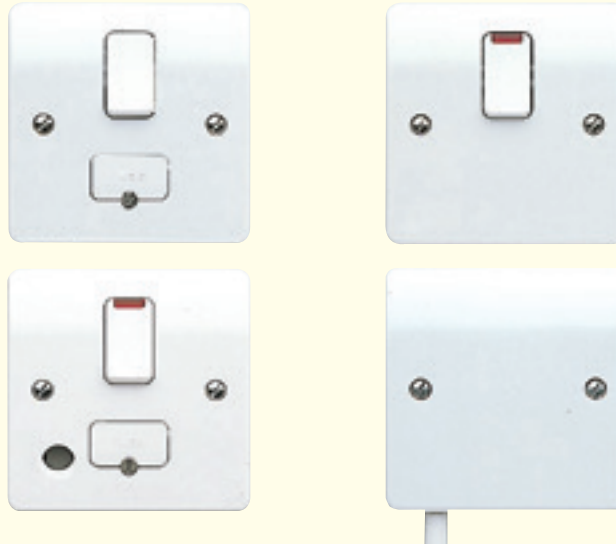

### Description

A range of 13A fused Connection Units and 20A DP switches designed for the connection of refrigerators, water heaters, central heating boilers and other fixed appliances.

The ranges are designed for ease of installation and have the advantageous design features of the Logic Plus™ range.

### Neon indicators

Neon indicators can be included in the rockers of the switched connection units. In the case of unswitched units, they are located centrally and uppermost on the front plate. Neon indicators are integrally wired into the product and do not require separate connection when installing.

The design gives 175° visibility in the horizontal and vertical planes.

### Fuse carriers

These are captive and are opened by a fast acting, screwdriver operated worm drive for ease of replacement.

### A tamper-proof version is also available.

Fuse carriers can be locked open using a padlock, List No. K2000.

### Flex outlets

Bottom outlet types are supplied with blanking plug allowing use where the bottom outlet is not required. Spare blanking plugs are available.

The products are equipped with very strong, push-fit nylon cord grips making installation safe, quick and easy.

### Flex outlet plate

An unfused flex outlet with cord grip plate and 3 pairs of terminals.

### Installation

#### Wiring

Products must be installed in accordance with current IEE Regulations.

#### Changing Fuses

1. Unscrew the fuse carrier screw to partially eject the carrier.
2. Carefully lever the carrier out further to remove the fuse. Note: The carrier does not come fully out.
3. Always replace with a BS 1362 type fuse (as used in 13A plugs) of the correct rating.
4. Consistent fuse blowing could mean a faulty appliance. If in doubt, consult a qualified electrician.
5. Push carrier back until engaging with jacking screw. Screw the carrier down until flush with surface of the plate. Do not over tighten the screw.

### Installation

Logic Plus™ connection units and 20A cable outlets and 20A switches can be wall or bench mounted. Do not use on a trailing lead.

### Cable Management

Logic Plus™ connection units and DP switches can be mounted in a variety of MK trunking systems.

## Connection Units, 20A Switches and Flex Outlets

### Features

- Optional indicators in the switch rockers with 175° visibility in the horizontal and vertical planes
- Worm-drive operated fuse carriers for additional security (tamper-proof version available)
- Fuse carrier lockable in open position
- All supply and load cables can be cut and stripped to the same length
- Integrally wired indicators save installation time
- Push-fit cord grips, for safer, quicker installation
- Angled, top mounted terminal screws simplify wiring
- Moulded 'on' indicator flash on switches cannot rub off – totally safe
- Captive fuse carrier
- Additional electrical safety from neutral 'make first', 'break last' feature
- Secure cable and flexible cord connection
- All terminal and fixing screws operated by one-size (4mm) screwdriver
- Backed out and captive terminal screws

Note: These switches are not recommended for switching large banks of PCs

### Dimensions (mm)

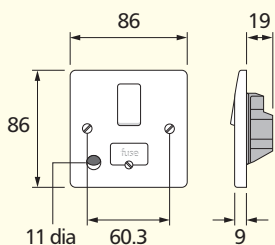

Products with front flex outlet

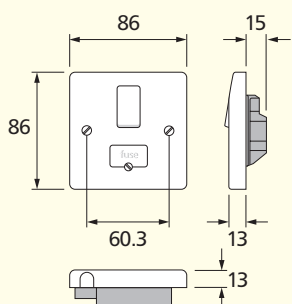

Products with flex outlet in base and thick frontplate

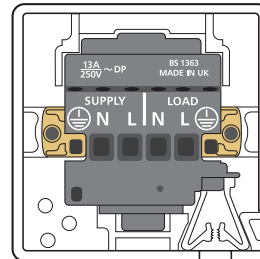

Supply and load cable cords cut and stripped to same length



Blanking plug for bottom outlet

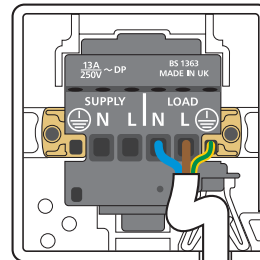

Bottom outlet and cord grip

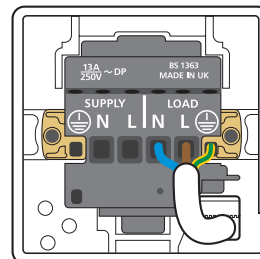
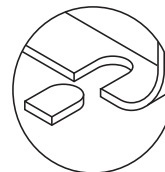

Front outlet cord grip



Lockable fuse carrier

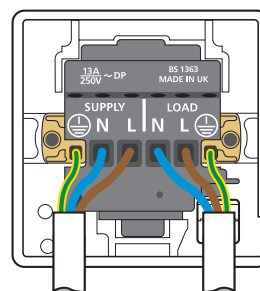

Supply and non flexible load cables



K1090WHI

**PLEASE NOTE THAT THE TERMINAL LAYOUT OF THE FLEX OUTLET, K1090, IS DIFFERENT TO THE OTHER SHOWN ABOVE.**

## 20A Lockable Fire Alarm Isolator Switch



### Description

The isolators comply with BS 60669-2-4: 2005

The Isolator is intended for use with building Alarm Systems that are required to comply with BS 5839 Part 1.

BS 5839 Part 1 states;

Clause 25.2c "To facilitate local isolation during maintenance, suitable means should be provided for double pole isolation of the low voltage supply circuit that serves the power supply and control equipment."

Clause 29.2e. "Means should be provided for double pole isolation of the mains supply to all parts of the system; the isolation facilities should be suitably sited, in the vicinity of the equipment served, for use by maintenance technicians without the need for access to remote parts of the building. It should be possible to lock the facilities in both the normal and isolate positions to prevent unauthorized use."

### Features

- The built in lock ensures power cannot be provided without the key being operated, making it safe to carry out maintenance to Fire Alarms
- Printed terminal markings on grey rear of the switch moulding for clearer identification
- Double Pole switching
- Only one size of screwdriver required for installation

### Technical specification

#### Electrical

Voltage rating:

240V a.c.

Current rating:

20 amp

Terminal capacity:

Live, Neutral & Earth 3 x 2.5mm<sup>2</sup>

3 x 4mm<sup>2</sup>

2 x 6mm<sup>2</sup>

#### Physical

Ambient operating temperature:

-5°C to +40°C

(not to exceed an average of more than 25°C in any 24 hour period)

IP rating:

With flex outlet: IP2XD

Without flex outlet: IP4X

Max. installation altitude:

2000 metres

IP rating:

IP2XD

Max. Installation altitude 2000 metres

Note: The lock fitted to these isolators is universal for all MK 20A Isolators in the range.

However, the keys are different to those used on all other MK Key Operated Switched Products, for added security.

## High Current Switches and Cooker Control Units

### Standards and approvals

All DP switches in the range conform to BS EN 60669-1: 1999

All Cooker Control Units in the range conform to BS 4177: 1992

Cooker Connection Unit conforms to BS 5733: 2010



### Technical specification

#### Electrical

Voltage rating:  
250V a.c.

Current:  
32A Switch  
45A Cooker Control Unit  
45A Cooker Connection Unit  
50A Switch (Resistive Load)

Switch:  
3mm contact gap  
Double pole operation –  
except socket switch on Cooker Control Unit

Terminal capacity, 50A switches, Cooker Control Unit and  
Cooker Connection Unit:  
4 x 4mm<sup>2</sup>  
3 x 6mm<sup>2</sup>  
1 x 16mm<sup>2</sup>

Terminal capacity, 32A Switch:  
3 x 2.5mm<sup>2</sup>  
2 x 4mm<sup>2</sup>  
1 x 6mm<sup>2</sup>

#### Physical

Ambient operating temperature:  
–5°C to +40°C  
(not to exceed an average of more than 25°C in any 24  
hour period)

IP rating:  
IP2XD (K5061, K5060, K5041, K5040, K5001, K5011,  
K5012)  
IP4X (K5105, K5205, K5215CK, K5215SH, K5230)

Max. installation altitude:  
2000 metres

### Features

- Positive switch action
- Positive double pole switching
- Toggle action switches
- Metal front plates available
- Replaceable neon indicators
- Wide product choice

Note: These switches are not recommended for switching large banks of PCs

### Description

A range of switches and cooker control units harmonising with the Logic Plus™ style, suitable for the switching of all domestic, commercial and industrial appliances where higher current ratings are required, i.e. cookers, heaters etc. Metal units are particularly suitable for refurbishment projects.

#### BOX DEPTHS

List No.	Max. Cable Size	Flush	Surface
<b>Switches</b>			
K5105WHI	6mm <sup>2</sup> 10mm <sup>2</sup>	35mm 46mm	30mm 40mm
K5205WHI	6mm <sup>2</sup> 10mm <sup>2</sup>	35mm 46mm	40mm 40mm
K5215WHI	6mm <sup>2</sup> 10mm <sup>2</sup>	35mm 47mm	40mm 40mm
K5230WHI	10mm <sup>2</sup>	–	Supplied with box
K5012WHI	10mm <sup>2</sup>	55mm	–

#### Cooker control units

K5040WHI	10mm <sup>2</sup>	–	Supplied with box
K5041WHI	10mm <sup>2</sup>	–	Supplied with box
K5060WHI	6mm <sup>2</sup> 10mm <sup>2</sup>	35mm 47mm	– –
K5061WHI	6mm <sup>2</sup> 10mm <sup>2</sup>	35mm 47mm	– –
K5001WHI	10mm <sup>2</sup>	–	Supplied with box
K5011WHI	10mm <sup>2</sup>	55mm	–

#### BOX REFERENCES

Box depth	Flush		Surface	
	1 gang	2 gang	1 gang	2 gang
30	–	–	K2140WHI	–
35	886ZIC	886ZIC	–	–
40	–	–	K2301WHI	K2172WHI
46	877ZIC	–	–	–
47	–	878ZIC	–	–
55	5120ALM (Cooker)	–	–	–



## High Current Switches and Cooker Control Units

### Dimensions (mm)

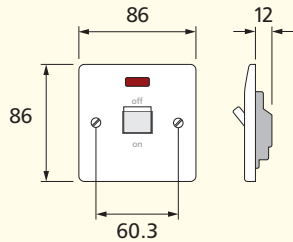

**K5105**

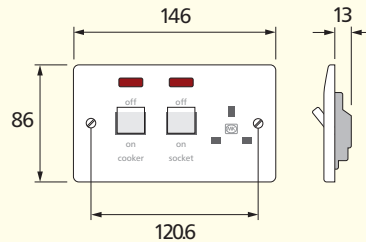

**K5061 or K5060 (without pilot lights)**

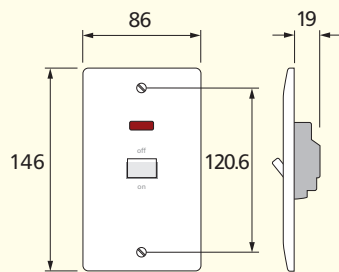

**K5215 or  
K5205 without pilot light  
K5215CK printed 'cooker'  
K5215SH printed 'shower'**

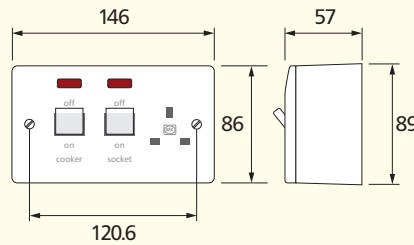

**K5041 or K5040 (without pilot lights)**

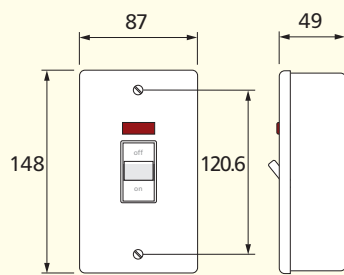

**K5230**

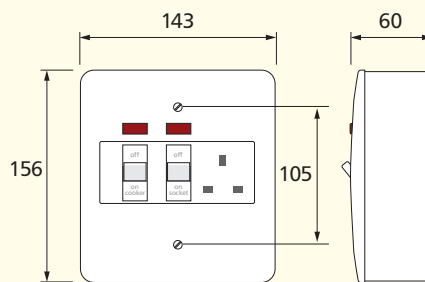

**K5001**

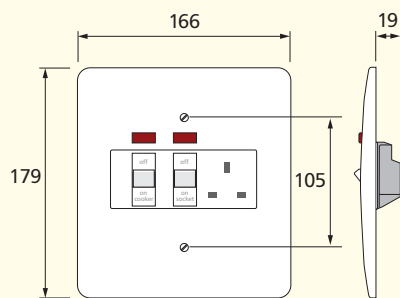

**K5011**

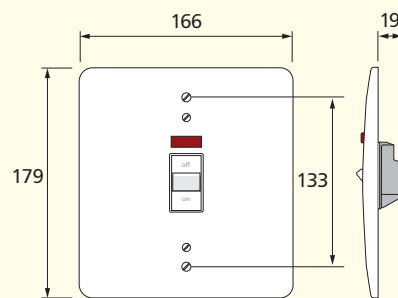

**K5012**

## Plateswitches

### Standards and approvals

All Logic Plus™ plateswitches comply with BS EN 60669-1: 1999

#### Technical specification

##### Electrical

Voltage rating:  
250V a.c. 50Hz

Current rating:  
10 amps – no derating when used on fluorescent  
or inductive loads

20 amps – no derating when used on fluorescent  
or inductive loads

Terminal capacity:  
All products except K4870/71/72

4 x 1mm<sup>2</sup>  
4 x 1.5mm<sup>2</sup>  
3 x 2.5mm<sup>2</sup>  
2 x 4mm<sup>2</sup>  
1 x 6mm<sup>2</sup>

For products K4870/71/72

4 x 1mm<sup>2</sup>  
4 x 1.5mm<sup>2</sup>  
2 x 2.5mm<sup>2</sup>  
1 x 4mm<sup>2</sup>

Contact gap:  
3mm switch contact gap

##### Physical

Operating temperature:  
–5°C to +40°C

IP rating:  
IP2XD

Max. installation altitude:  
2000 metres

Operational testing (all plateswitches):  
tested to 100,000 operations for mechanical life  
tested to 40,000 operations at 10 amp rating  
tested to 10,000 operations at 20 amp rating

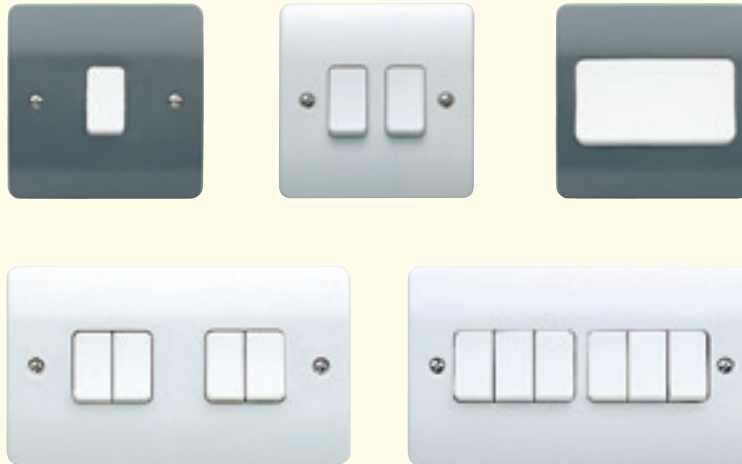

### Description

Logic Plus™ plateswitches are designed to blend in with the decor, whilst complementing a wide range of other Logic Plus™ accessories. They are designed for easy installation in plaster depth boxes and are suitable for controlling lighting circuits in domestic, commercial and industrial applications.

### Neon locator

A textured, polycarbonate moulding allowing the glow of the neon to be seen at almost any angle. Designed to complement the Logic Plus™ 1, 2, or 3 gang plateswitches.

It is easy to install in existing locations. For 3 gang applications using a 25mm deep box simplifies wiring.



### Features

- Two way switches can be wired as one or two way
- All products clearly printed with BS Nos., ratings, etc
- Matching Grid switches available in 10 or 20A ratings
- 3mm switch contact gap
- Positive switch action
- Top access, backed out and captive terminal screws (except Logic Plus list numbers K4870, K4871 and K4872)
- Neon locator available making switch easy to find in darkened rooms

### Cable Management

Logic Plus™ plateswitches can be mounted in a variety of MK trunking systems.

## Plateswitches

### Dimensions (mm)

#### 1 gang

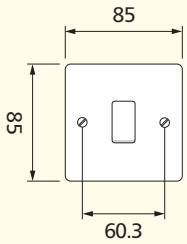

#### 2 gang

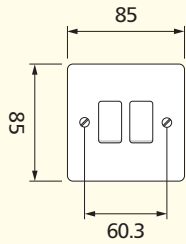

#### 3 gang

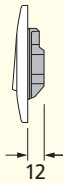
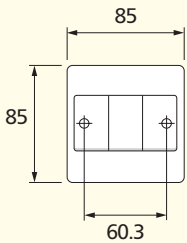
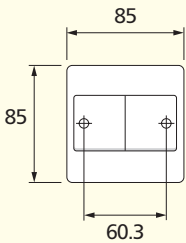
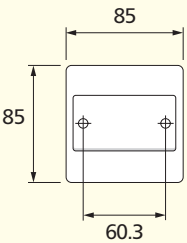
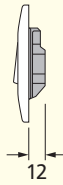
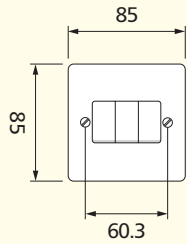

#### 4 gang

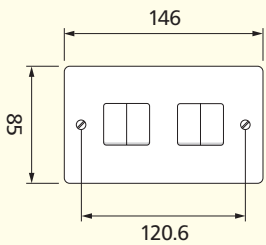

#### 6 gang

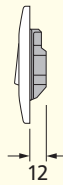
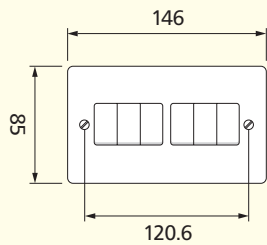

#### 1 gang architrave

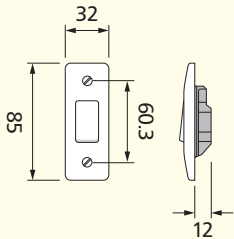

#### 2 gang architrave

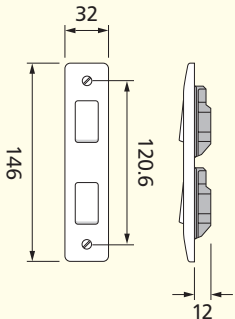

Sectional drawings show the furthest projections from the back of the frontplate (wall surface).

### Wiring Diagrams

#### One-way switching

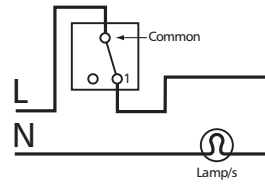

#### Two-way switching – 2 wire control

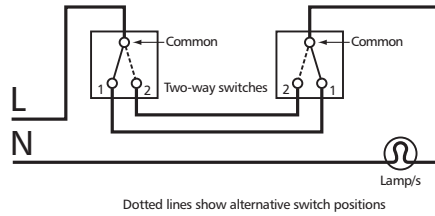

#### Two-way switching plus intermediate switching – 2 wire control

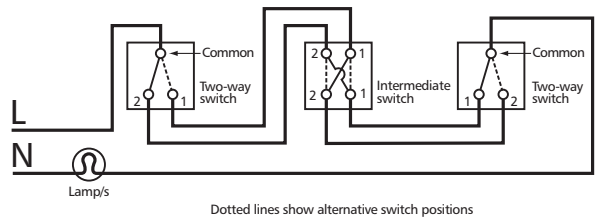

#### Two-way switching – 3 wire control

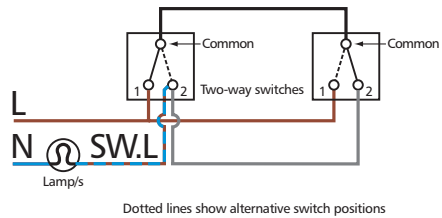

#### Two-way switching plus intermediate switching – 3 wire control

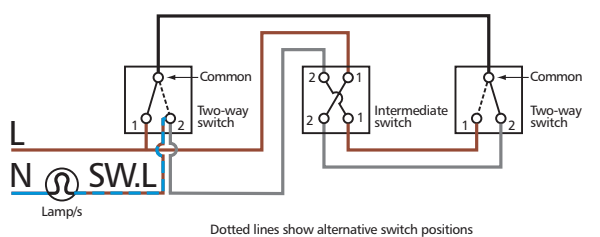

N.B. Terminal positions may alter. The above diagrams are to show wiring layout.

## Dimmer Switches

### Standards and approvals

All CE marked Logic Plus™ dimmer switches comply with the EC Low Voltage Directive: 73/23/EEC, Electromagnetic Compatibility Directive 89/336/EEC

They also comply with BS EN 60669-2-1 and IEC 60669-2-1 (LED Intelligent Dimmer only)

\*Non-UK dimmer switches see note below

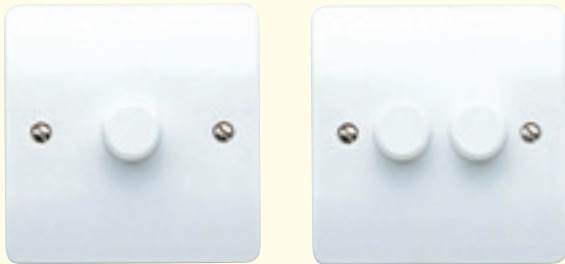

### Dimensions (mm)

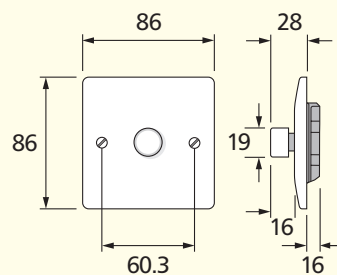

### Description

MK dimmer switches can fall into one of six categories:

- 1) Standard Dimmer Switches
- 2) Intelligent Dimmer Switches
- 3) Non-UK Dimmer Switches
- 4) CFL Lamp Dimmer Switches
- 5) LED Intelligent Dimmer Switches
- 6) LED Standard Dimmer Switches

#### Standard and LED Standard Dimmer Switches

Dimmer Switches belonging to this category employ simpler electronic circuitry and the CE marked products make use of thermal switches to conform to the very stringent requirements of the Standard BS EN 60669-2-1, for overload protection. They are only suitable for use with normal tungsten filament lamps with internal fuses, conforming to BS EN 60064: 1996 and BS EN 60432-1 Standards and do not have any added features, e.g. soft start, ability to control dimmable transformers for low voltage, etc.

LED Standard Dimmer switches have an optimised design for use with recommended lamp types only. Check MK web site for compatibility details.

**Standard and LED Standard Dimmer Switches are not suitable for use with transformers for Low Voltage Lighting or Fluorescent Loads, including Energy Saving Lamps.**

#### Intelligent and LED Intelligent Dimmer Switches

Dimmer Switches belonging to this category, employ the latest, state of the art, micro-controller based electronic circuitry and use current sensing to compute the load conditions. These products show progressive reaction to overload conditions, depending on the extent of overload as shown in the table below. List numbers belonging to this category are identified by the suffix letters LV, e.g. K1501 WHI LV. All MK Intelligent Dimmer Switches employ one pole change over switches to facilitate two way switching.

**MK Intelligent and LED Intelligent Dimmer Switches are not suitable for use with Fluorescent Loads, including Energy Saving Lamps.**

#### \*Non-UK Dimmer Switches

Dimmer switches belonging to this category only conform to the relevant parts of BS EN 60669-2-1. Loads suitable for use with standard dimmer switches above are also suitable for use with this category of dimmer switch.

#### CFL Lamp dimmer switches

Dimmer switches belonging to this category employ the latest, state of the art, micro-controller based electronic circuitry used in other intelligent dimmer switches. In addition they utilise control software to improve performance and life of dimmable compact fluorescent lamps.

**Only one Dimmer Switch can be used in a two-way switching circuit.**

### Technical specification

#### Electrical

Mains Supply Voltage:  
230V a.c. (Nominal)  
220V a.c. (Nominal, Non-UK)  
220V a.c. to 240V a.c. (For LED Intelligent Dimmer)

Mains Supply Voltage Range:  
216V a.c. to 253V a.c.  
200V a.c. to 250V a.c. (Non UK)  
198V a.c. to 264V a.c. (For LED Intelligent Dimmer)

Mains Supply Frequency:  
50Hz  $\pm$ 3Hz  
60Hz  $\pm$ 3Hz (Non UK)

Type of Loads:

#### Standard Dimmers:

Fused GLS Tungsten Filament lamps only to BS EN60064: 1996 and BS EN60432-1: 2000, rated at 230/240V

#### LED Standard Dimmers:

Use with good quality branded dimmable LED lamp types only. Check compatibility on MK web site for details.

#### Intelligent Dimmers and

#### LED Intelligent Dimmers:

Fused GLS Tungsten Filament lamps to BS EN60064: 1996 and BS EN60432-1,2 rated at 230/240V. Dimmable wire wound or electronic Low Voltage Transformers of good quality. Can also be used with good quality mains voltage halogen lamps incorporating GU10 bases. Please check with lamp manufacturer to determine suitability.

In addition, LED Intelligent dimmers are suitable for dimmable LED bulbs rated at 220-240V for incandescent replacement.

Note: Transformer must be suitable for dimming using phase delay (leading edge) and NOT only phase cut (trailing edge) type of dimmers.

**Warning: These dimmer switches are not suitable for use with Fluorescent Lamps or Energy Saving Lamps.**

#### CFL lamp dimmers:

Dimmable compact fluorescent lamps rated at 220/240V.

#### Physical

Operating temperature:  
0°C to +40°C

IP rating:  
IP2XD

Max. installation altitude:  
2000 metres

## Dimmer Switches

### Features

**Intelligent and LED Intelligent Dimmer Switches** incorporate the following advanced features

- Suitable for dimming Low Voltage Halogen lamps via good quality, fully dimmable electronic or wire-wound transformers. In addition, LED Intelligent dimmer switches are suitable for dimmable LED bulbs for incandescent replacement.
- Can be used with good quality mains voltage halogen lamps incorporating GU10 bases. Please check with lamp manufacturer to determine suitability
- Load current sensing: These dimmers continuously monitor the load current to help protect against overheating in wire wound transformers and to prevent overloading of the dimmer for long term reliability.
- Soft Start, which gradually increases the light output from the load over 1 to 3 seconds after switch on. The Soft Start feature is also particularly beneficial when used to dim Mains Voltage Tungsten Halogen lamps which inherently have a very high inrush current at switch on

### Standard Dimmer Switches

- Suitable only for use with fused GLS Tungsten Filament lamps to BS EN 60064 and BS EN 60432-1
- One way dimmer switches incorporate manual soft start
- Incorporate thermal switches for protection against overload

### CFL Lamp dimmer switches

- Suitable only for use with compact fluorescent lamps designed specifically for dimming.
- Load current sensing: These dimmers continuously monitor the load current to help prevent overloading of the dimmer for long term reliability.
- Full brightness start to increase lamp life, the dimmer will reduce the light level to the level set within 2 - 3 seconds.
- Total connected load must not be less than the minimum power load rating of 11W.
- A maximum of 4 lamps only must be connected to each dimmer switch.

Please note the dimmer may be substituted for any of the Two-Way switches shown on page 51.

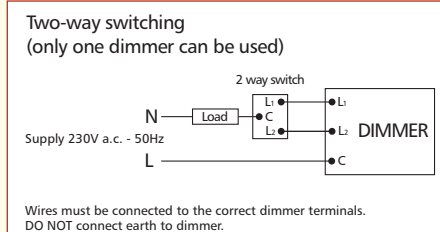
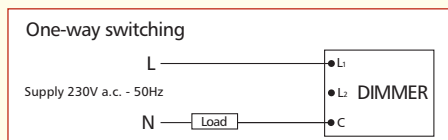

60-500W CIRCUIT	40-300W CIRCUIT	LED INTELLIGENT DIMMER
<b>Overload management:</b> 60-500W nominal 60-625W function without dimming > 625-1000W dim minimum level > 1000W switch off	<b>Overload management:</b> 40-300W nominal 40-375W function without dimming > 375-600W dim to minimum level > 600W switch off	<b>Overload management:</b> 40-300W nominal 40-375W function without dimming > 375-600W dim to minimum level > 600W switch off

LOAD TYPES AND LOADINGS						
Dimmer Series	Dimmer Size (1 gang)	Rating			Max No. of Transformers and LEDs (total rating must not exceed MAX.VA rating of dimmer)	
		GLS and mains voltage halogen	Electronic or wire wound LV transformers	LED	Transformers	LEDs
INTELLIGENT DIMMER SWITCHES	single dimmer	40-300W	40-240W/VA	-	4	-
	double dimmer	2 x 40-300W	2 x 40-240W/VA	-	4 per dimmer	-
	single dimmer	60-500W	60-400W/VA	-	5	-
LED STANDARD DIMMER SWITCHES	single dimmer	-	-	8-48W	-	10
	double dimmer	-	-	2 x 8-48W	-	10 per dimmer
LED INTELLIGENT DIMMER SWITCHES	single dimmer	40-300W	40-240W/VA	4-70W	4	10
	double dimmer	2 x 40-300W	2 x 40-240W/VA	2 x 4-70W	4 per dimmer	10 per dimmer

Do not connect more than the maximum number of transformers stated for each dimmer.

## Minimum Brightness Adjustment for LED Intelligent Dimmers

The light output of some LED lamps may appear to be too dim or invisible when the dimmer knob is at the minimum dim level. Follow the steps below to adjust the minimum brightness level. This feature is primarily for adjusting the minimum brightness level of the LED lamp although it can be used for other load types. For a double gang dimmer, the light level of each gang has to be adjusted separately.

### Step 1 Access To Programming Mode

1. Push the dimmer knob so that it is in OFF state.
2. Set the dimmer knob to minimum level.

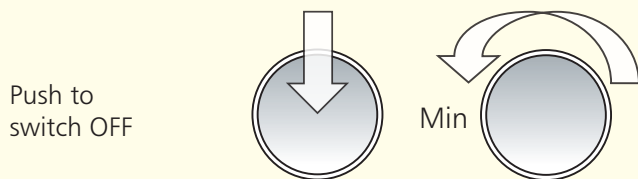

3. Turn on the dimmer and immediately rotate the knob 3 times in full rotary span within 5 seconds.

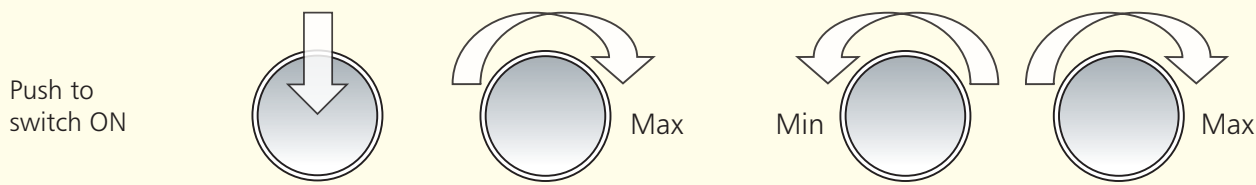

NOTE: - Wait for 3 seconds, the lamp will then dim to minimum before automatically brightening to about 30% level.

Turning/pushing the dimmer knob before the end of automatic brightening will end access to programming mode

4. Dimmer enters programming mode.

### Step 2 Adjust Brightness Level and Exit Programming Mode

5. Rotate the dimmer knob anticlockwise to adjust the lamp to the desired brightness level.

NOTE: - Some LED lamps may not work properly if the brightness level is set too low thus it is recommended to keep the brightness level of the lamp at a visible level. The dimmer will exit programming mode automatically without saving the new setting if there is no dimmer knob movement for 15 seconds. The dimmer will restore its factory default light level.

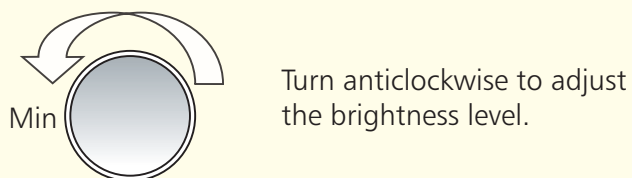

6. Confirm the new setting and exit programming mode by turning OFF the dimmer.

Push to switch OFF

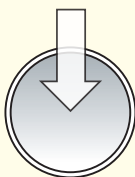

### Step 3 Success indication (Programming Complete)

7. The next time the dimmer is turned on the lamp will automatically brighten to the maximum level before dimming to the brightness level corresponds to the knob level.

## Euro and LJU6C Data Frontplates

### Standards and approvals

BS 5733: 2010

#### Technical specification

##### Dimensions

Height: 85.75mm  
 Width: 85.75mm (1G)  
 147mm (2G)  
 Depth: 9mm

##### Aperture Dimensions (nominal)

###### Euro Frontplates

Height: 50mm  
 Width: 50mm (1G)  
 100mm (2G)

###### LJU6C Frontplates

Height: 37mm  
 Width: 22mm

#### Features

- 1G, 2G and 3G Euro Frontplates
- 1G LJU6C Frontplate
- Logic Plus™ style
- Colour matched to MK Logic Plus™ range
- Accept industry standard Euro or LJU6C snapfit modules
- 1G Euro frontplates accept 1 or 2 Euro modules, (25x50mm or 50x50mm aperture)
- 1G Euro frontplate accepts 4 Euro modules, (100 x 50mm aperture)
- 1G LJU6C frontplate accepts two LJU6C modules (27 x 37mm aperture)
- 1/2 module (12.5 x 50mm) blank available for Euro frontplates

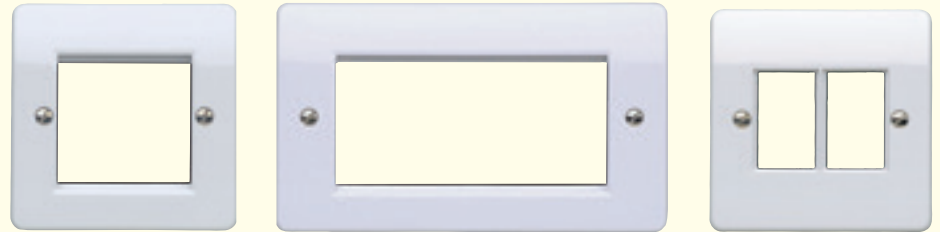

### Description

Frontplates used for mounting snapfit data modules.

### Dimensions (mm)

#### Euro Frontplates

##### 1 Gang 1 & 2 module

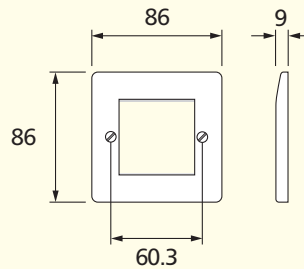

K181WHI/K182WHI

#### LJU6C Frontplates

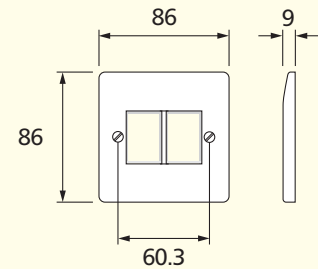

K172WHI

##### 2 Gang 4 module

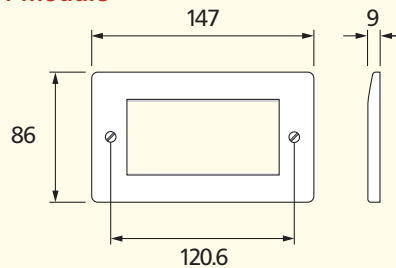

K184WHI

##### 3 Gang 6 module

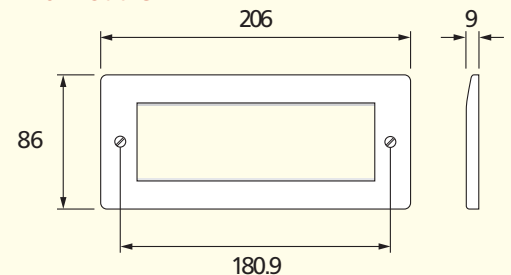

K185WHI

## Power Modules

### Standards and approvals

K5830: BS 1363 Part 2: 1995

K5833: BS 546: 1950

K5831: IEC 60884-1: 2006

K5834: French National Standard

K5832: SASO 2203: 2003

NF C 61-314

### Description

A range of euro modules designed to provide a variety of power options.

#### Technical specification

13A UK	5A UK	16A German	16A French/Belgian	15A American	1A USB Charging Module
<b>Electrical</b>	<b>Electrical</b>	<b>Electrical</b>	<b>Electrical</b>	<b>Electrical</b>	<b>Electrical</b>
Voltage rating: 250V a.c.	Voltage rating: 250V a.c.	Voltage rating: 250V a.c.	Voltage rating: 250V a.c.	Voltage rating: 127V a.c.	<b>Input</b> Voltage rating: 220-240V a.c. Frequency : 50Hz Rated Current: 0.6A Terminal Capacity: Live & neutral 1 x 2.5mm <sup>2</sup>
Current rating: 13A	Current rating: 5A	Current rating: 16A	Current rating: 16A	Current rating: 15A	<b>Output</b> Voltage rating: 2 x 5V d.c. Max current: 1A per socket Charging sockets: USB 2.0 type A
Terminal capacity: Live, neutral & earth 3 x 2.5mm <sup>2</sup> 3 x 4mm <sup>2</sup> 2 x 6mm <sup>2</sup> (stranded)	Terminal capacity: Live, neutral & earth 3 x 2.5mm <sup>2</sup> 2 x 4mm <sup>2</sup> 2 x 6mm <sup>2</sup> (stranded)	Terminal capacity: Live, neutral & earth 4 x 1.5mm <sup>2</sup> 2 x 2.5mm <sup>2</sup> 1 x 4mm <sup>2</sup>	Terminal capacity: Live, neutral & earth 3 x 2.5mm <sup>2</sup> 2 x 4mm <sup>2</sup> 1 x 6mm <sup>2</sup>	Terminal capacity: Live, neutral & earth 3 x 2.5mm <sup>2</sup> 2 x 4mm <sup>2</sup> 1 x 6mm <sup>2</sup> (stranded)	
<b>Physical</b>	<b>Physical</b>	<b>Physical</b>	<b>Physical</b>	<b>Physical</b>	<b>Physical</b>
Ambient operating temperature: -5°C to +40°C (not to exceed an average of more than 25°C in any 24 hour period)	Ambient operating temperature: -5°C to +40°C (not to exceed an average of more than 25°C in any 24 hour period)	Ambient operating temperature: -5°C to +40°C (not to exceed an average of more than 25°C in any 24 hour period)	Ambient operating temperature: -5°C to +40°C (not to exceed an average of more than 25°C in any 24 hour period)	Ambient operating temperature: -5°C to +40°C (not to exceed an average of more than 25°C in any 24 hour period)	Ambient operating temperature: 0°C to +40°C
IP rating: IP2XD	IP rating: IP2XD	IP rating: IP2XD	IP rating: IP2XD	IP rating: IP2XD	IP rating: IP2XD
Max. installation altitude: 2000 metres	Max. installation altitude: 2000 metres	Max. installation altitude: 2000 metres	Max. installation altitude: 2000 metres	Max. installation altitude: 2000 metres	Max. installation altitude: 2000 metres

#### Dimensions (mm)

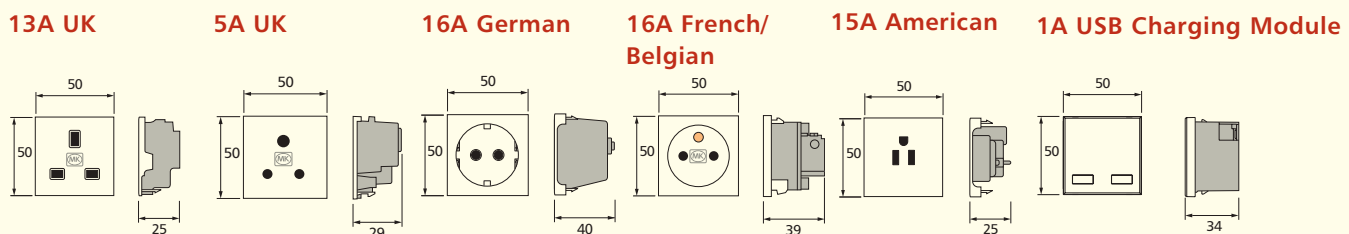

K5830

K5833

K5831

K5834

K5832

K5837

BOX TYPES	BOX TYPES	BOX TYPES	BOX TYPES	BOX TYPES	MK EURO FRONT PLATE THICKNESS	BOX TYPES
<b>Minimum</b>	<b>Minimum</b>	<b>Minimum</b>	<b>Minimum</b>	<b>Minimum</b>		
35mm	35mm	46mm	46mm	35mm	> 7mm	Min 35mm
<b>Extra wiring space</b>	<b>Extra wiring space</b>			<b>Extra wiring space</b>	< 7mm	Min 46mm
46mm	46mm			46mm		



## RJ45 Data Outlets

### Standards and approvals

ISO/IEC 11801  
EN 50173  
TIA 568  
EN 41003



### Description

Suitable for use in all LUJ6C, Euro and MK Modular frontplates, available in the Logic Plus range, Cat 5e and Cat 6 modules suitable for use in structured cabling distribution systems.

### Installation

- Maximum cable length 90m.
- Cable bend radii, 40mm during installation, 20mm after installation.
- Maximum pull force 8.7kg.
- Do not over tighten cable ties.
- Do not unwind the twists in the wire pairs by more than 13mm max.

### Installation details and wiring diagram illustrations

#### TIA WIRING SCHEME COLOUR CODES:

Pin No.	568A	568B
1	WHITE / green	WHITE / orange
2	GREEN / white	ORANGE / white
3	WHITE / orange	WHITE / green
4	BLUE / white	BLUE / white
5	WHITE / blue	WHITE / blue
6	ORANGE / white	GREEN / white
7	WHITE / brown	WHITE / brown
8	BROWN / white	BROWN / white

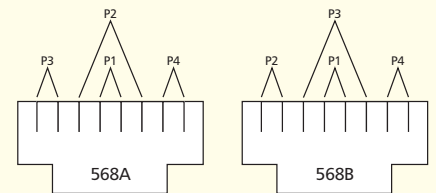

Pair 1 – BLUE/white & WHITE/blue  
Pair 2 – ORANGE/white & WHITE/orange  
Pair 3 – GREEN/white & WHITE/green  
Pair 4 – BROWN/white & WHITE/brown

### Euro and LUJ6C modules are to be wired as follows

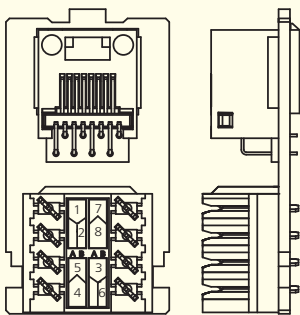

RJ45 Cat.5e Euro K5845

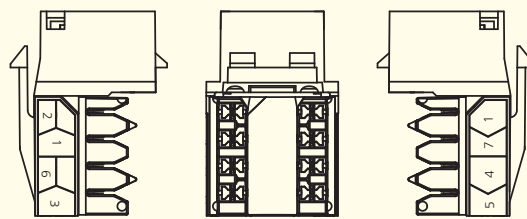

RJ45 Cat.5e Euro - Angled K5844

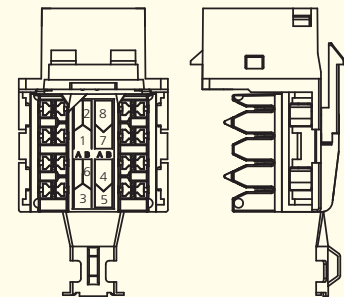

RJ45 Cat.6 Screened K5746S - LUJ6C, K5846S - Euro

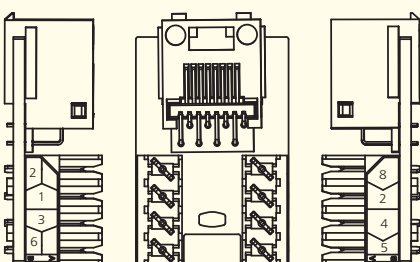

RJ45 Cat.5e LUJ6C K5745

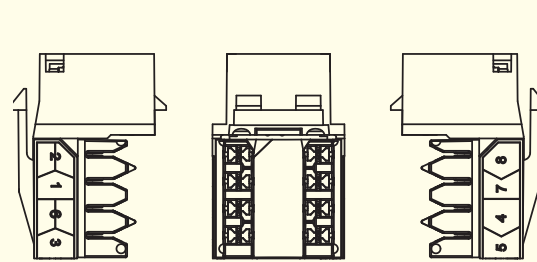

RJ45 Cat.6 Euro - Angled K5746 - LUJ6C K5846 - Euro, K5864 - Euro Angled

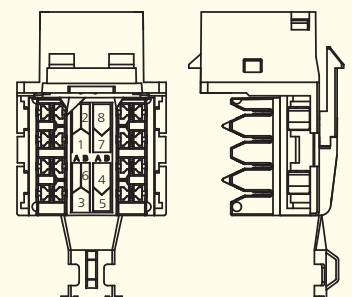

RJ45 Cat.5e Screened K5845S - Euro

## Telephone, RJ11/12, BNC Data and Blank Modules

### Standards and approvals

Telephone sockets K5820 and K5821 comply with the following:

BS 6312: 2.2

Data sockets K5801, BS 5733: 2010 (where applicable).

K5887 complies with FCC68 and EN 41003.



### Technical specification

#### Electrical

Cable types:

Telephone: CW1311, CW1293, CW1308, CW1316

No. of cables per termination:

Telephone: 2

RJ11/12: 1

BNC

50 Ohms impedance cable – RG58, RG141, URM43 Belden 9907

Frequency range:

BNC connector: 0 to 4GHz

Impedance:

BNC Connector: 50. nominal

Termination type:

Telephone module – IDC

BNC module – Crimped connection

#### Physical

Temperature range:

Ambient air –20°C to +60°C

IP rating:

IP2XD – K5820, K5821, K5801 and K5787.

IP4X – K180, K188, K186 and K170

Max. installation altitude:

2000 metres

### Description

A range of telephone, data and blank modules to fit Euro and LJ6UC front plates. BNC Euro modules with a 50Ohm crimp connector suitable for use with RG58, URM43, URM76 and Belden 9907 type co-axial cables are also available.

### Installation (Telephone socket modules)

#### Product performance, systems compatibility

Master Sockets: For use as the first socket outlet on a direct exchange. They contain the required surge protector (for line protection against electrical surges) and ringing capacitor.

Secondary Sockets: for use as extension sockets when connected on the same line as a Master Socket.

#### Installation tools required IDC Connectors (telephone & RJ45 outlets)

MK insertion tool List No. 400NAT.

Wire pull-out force: 10.5 Newtons when installed correctly.

#### Wiring regulation restrictions

Domestic Installations: The total REN (Ring Equivalent Number) value of all telephone equipment connected on a line must not exceed 4.

### Features

- Meet all relevant BS, OFTEL and cabling standards
- Interchangeable modules clip into frontplates
- Front fixing facilitates easy exchange of modules
- Part of a complete range of products for telephone and data processing requirements
- Can be specified for all applications

#### Data sockets

- Latest specification for high performance systems
- Made to stringent quality assurance procedures
- Wide range of data connectors available

#### Telephone sockets

- 100% tested before delivery
- Quick, simple and reliable IDC connectors

For information on TV Satellite and FM Modules see pages 451-453

## Telephone, RJ11/12, BNC Data and Blank Modules

### Telephone Wiring Scheme

- 1 GREEN / white
- 2 BLUE / white
- 3 ORANGE / white
- 4 WHITE / orange
- 5 WHITE / blue
- 6 WHITE / green

**Note:** Main wire colour is shown in capitals

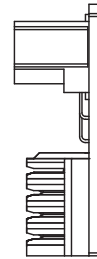
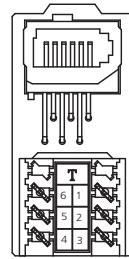
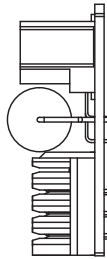
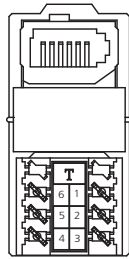

K5820

K5821

First Socket Outlet  
Master

Extension Outlet  
Secondary

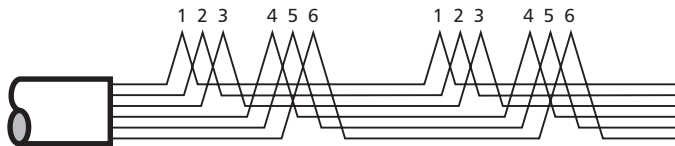

### RJ11/12 Wiring Scheme

PIN NO.	STRIPPED COLOUR WIRE	SOLID COLOUR WIRE
1	WHITE / green	WHITE
2	WHITE / orange	BLACK
3	BLUE / white	RED
4	WHITE / blue	GREEN
5	ORANGE / white	YELLOW
6	GREEN / white	BLUE

**Note:** Main wire colour is shown in capitals

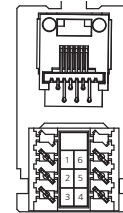
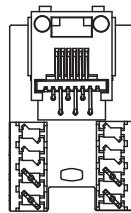

K5787

K5887

## MK Modular Datacoms

### Standards and approvals

Logic Plus™ Telephone and Data sockets comply with the following:

Telephone sockets K420 and K421

BS 6312: 2.2, OFTEL Approval NS/G/23/L/100005

Modular Frontplates K190 to K194

BS 5733: 2010 (where applicable)



### Technical specification

#### Electrical

Cable types:

Telephone CW1311, CW1293, CW1308, CW1316

No. of cables per termination:

Telephone: 2

Termination type:

RJ11 & Telephone - IDC

#### Physical

Temperature range:

Ambient air -20°C to +60°C

IP rating:

IP2XD

Max. installation altitude:

2000 metres

### Description

A unique modular system in the distinctive Logic Plus™ style comprising a range of socket modules for Data and Telephone use, with 4 matching frontplates capable of accepting combinations of interchangeable modules. The 'clip-in' design provides a high degree of versatility, making the system ideal for use in all commercial and industrial applications.

### Features

- Meet all relevant BS, OFTEL and cabling standards
- Interchangeable modules clip into frontplates
- Front fixing facilitates easy exchange of modules
- Part of a range of products for telephone and data processing requirements
- Quick, simple and reliable IDC connectors
- Can be specified for many applications
- Fit in plaster depth boxes

### BOX TYPES

Where there is more than one module in a frontplate, the depth of the box is determined by the module with the deepest back projection.

Ref.	Min. box depth mm	Flush box List No.	Surface box List No.
K420	16	3995ZIC	K2160 & 2161WHI
K421	16	3995ZIC	K2160 & 2161WHI
K190	16	3995ZIC	K2160 & 2161WHI
K487	16	3995ZIC	K2160 & 2161WHI

### Dimensions – Data and TV modules (mm)

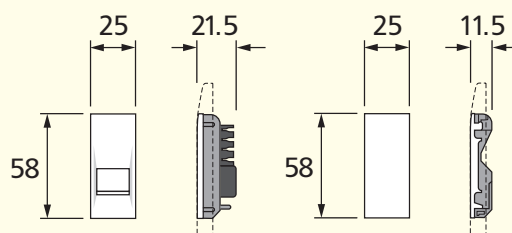

K420 / K421

K190WHI

## MK Modular Datacoms

### Dimensions – Modular frontplates (mm)

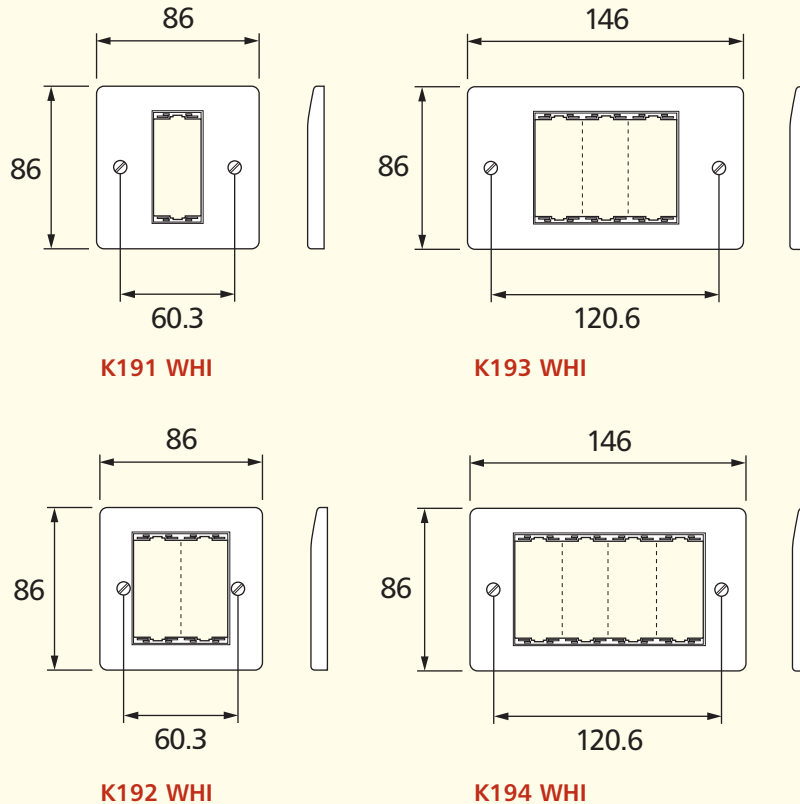

### Installation (Telephone socket modules)

#### Product performance, systems compatibility

**Master Sockets:** For use as the first socket outlet on a direct exchange. They contain the required surge protector (for line protection against electrical surges) and ringing capacitor.

**Secondary Sockets:** for use as extension sockets when connected on the same line as a Master Socket.

#### Installation tools required IDC Connectors (Telephone & RJ11 outlets)

MK insertion tool List No. 400NAT.

Wire pull-out force: 10.5 Newtons when installed correctly.

#### Wiring regulation restrictions

**Domestic Installations:** The total REN (Ring Equivalent Number) value of all telephone equipment connected on a line must not exceed 4.

**Industrial and commercial installations:** MK telephone sockets are suitable in all situations after the PBX/PABX has been installed by a recognised installer. For key systems and other 'special' systems, the manufacturer's instructions should be referred to.

#### Safety information

None of the above products should be installed into the same fixing or mounting boxes as mains rated equipment or cable.

#### Cable management

Logic Plus™ Modular Data and Telephone Sockets can be mounted in a variety of MK trunking systems. See main catalogue for further details.

#### RJ11 Wiring Scheme

PIN NO.	STRIPPED COLOUR WIRE	SOLID COLOUR WIRE
1	WHITE / green	White
2	WHITE / orange	Black
3	<b>BLUE / white</b>	<b>Red</b>
4	<b>WHITE / blue</b>	<b>Green</b>
5	ORANGE / white	Yellow
6	GREEN / white	Blue

**Note:** Main wire colour is shown in capitals

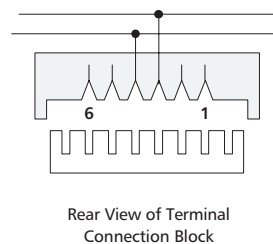

Rear View of Terminal Connection Block

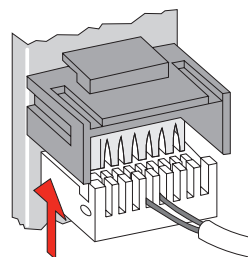
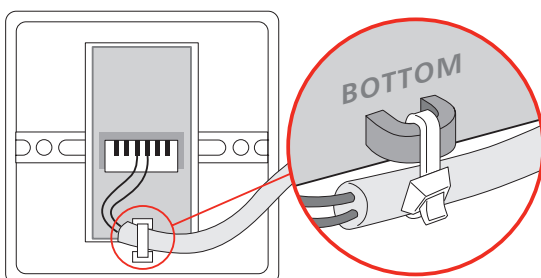

## Telephone, TV/FM and Satellite Socket Outlets

### Standards and approvals

Logic Plus™ Telephone and TV sockets comply with the following:

#### Telephone sockets K422 and K427

BS 6312: 2.2, BS 5733: 2010 (where applicable).

K4817: BS 5733: 2010 (where applicable) and FCC68.

#### TV sockets K3520, K3521 and K3523

BS 3041: Part 2: 1977/IEC 169-2: 1977, BS5733: 2010 (where applicable) and IEC65, Cls 10.1, 10.3.

#### TV sockets K3525

BS 5733: 2010 (where applicable).



### Description

A part of the very wide range of products in the distinctive Logic Plus™ style to meet the latest technical requirements and the standards applicable to modern technology in the installation of telephone and television equipment. The master and secondary telephone sockets K422 and K427 comply with relevant approvals for direct and indirect connections between a termination point of a public telecommunications system and any piece of approved telecommunications apparatus. For applications requiring twin or dual telephone outlets, refer to 'Modular Data and Telephone Sockets'.

Logic Plus™ Telephone and TV sockets will fit in plaster depth boxes (except for RJ11).

The F-type Satellite Socket may be used for connection of CATV, MATV and satellite TV installations.

Digital TV outlets are available.

### Technical specification

#### Electrical

Telephone sockets, cable specification:  
CW1311, CW1293, CW1308, CW1316  
No. of cables per termination: 2

Re-usability:  
>9 reterminations (should not be reterminated with smaller diameter wire)

TV sockets:  
Cable specification: CT 100 or equivalent  
Any standard low-loss TV co-axial cable:  
Outside 4-8mm diameter,  
inner conductor 0.5-2mm diameter

Insertion loss:  
Insertion loss data available on request

'F' Type satellite socket (K3525), cable specification:  
Co-axial cable: inner core diameter – 0.5-1.2mm

RJ11 (K4817), Cable specification:  
Capable of taking 0.08 to 0.65mm<sup>2</sup> solid or stranded cable

#### Physical

Ambient air:  
–20°C to +60°C

IP rating:  
IP2XD

Max. installation altitude:  
2000 metres

### Features

- Single screw termination on TV outlets
- Protected, fully enclosed PCBs
- Meet all relevant BS requirements
- Attractive new easy-clean Logic Plus™ styling
- Quick, simple and reliable terminal connection
- IDC connectors on telephone outlets
- Part of a complete range of products for telephone, television and data processing requirements
- Angled connector on TV outlets
- Sockets fit in plaster depth boxes (except K4817)

## Telephone, TV/FM and Satellite Socket Outlets

### Dimensions (mm)

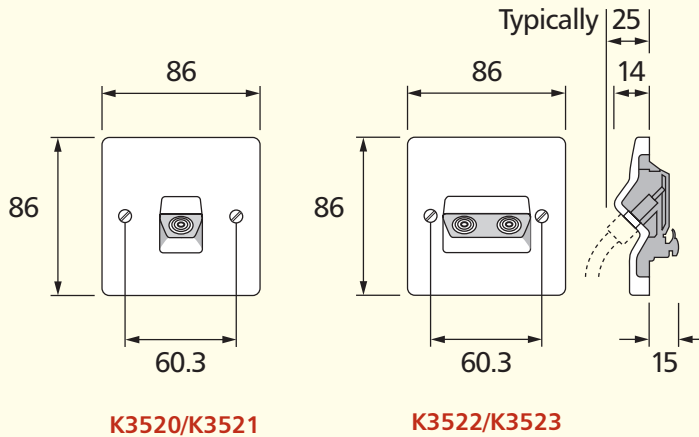

Sectional drawings show the furthest projections from the back of the frontplate (wall surface), including a typical coaxial connector in the case of TV sockets. All units will fit in 16mm plaster depth boxes except for K4817 (Western Telecom socket).

BOX TYPES		
	Flush	Surface
1 gang	861ZIC	K2140WHI

### Installation (Telephone sockets)

#### Product performance, systems compatibility

**Master Sockets:** for use as the first socket outlet on a direct exchange or PABX line. They contain surge protector (for line protection against electrical surges) and ringing capacitor.

**Secondary Sockets:** For use as extension sockets when connected on the same line as a Master Socket.

#### Installation tools required

MK IDC insertion tool List No. 400NAT (not supplied with product).

#### Wiring regulation restrictions

**Domestic installations:** Any number of MK sockets may be installed thereafter, with a total REN (Ring Equivalent Number) value of all telephone equipment connected on a line not exceeding 4.

### Telephone Wiring Scheme

- 1 GREEN / white
- 2 BLUE / white
- 3 ORANGE / white
- 4 WHITE / orange
- 5 WHITE / blue
- 6 WHITE / green

**Note:** Main wire colour is shown in capitals

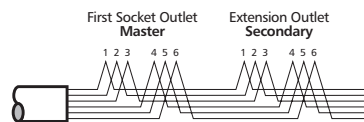
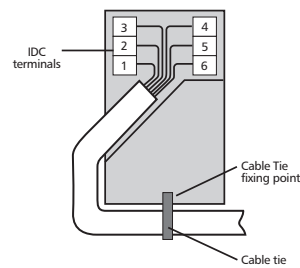

## Telephone, TV/FM and Satellite Socket Outlets

### Installation (TV sockets)

#### Product performance, systems compatibility

Isolated Outlets are intended for use where safety isolation (rated at 2000V ac) is required to provide protection against faults occurring within any mains powered product used on different parts of the distribution system. They are not suitable for use in systems where DC signals are passed through the socket, (e.g. where masthead/headend equipment is controlled by receiver/decoder equipment).

Diplexer Outlets are used in distribution systems where both TV and FM band signals are combined on a single aerial download. The filtering in the diplexer separates the appropriate signals and feeds them through to the relevant output connection port.

#### Cable Routing and Use of Cable Clamp

Sharp bends in the cable must be avoided during installation. The single TV/FM socket is fitted with a cable clamp that can be fixed on either side of the termination position to facilitate this.

When tightening the screening braid clamps ensure that the cable is firmly gripped and that the inner insulation is not squashed flat beyond a slight oval shape.

#### Safety Information

TV outlets or modules must not be installed in the same enclosure as equipment rated in excess of 50V, (e.g. mains rated 13A sockets or switches).

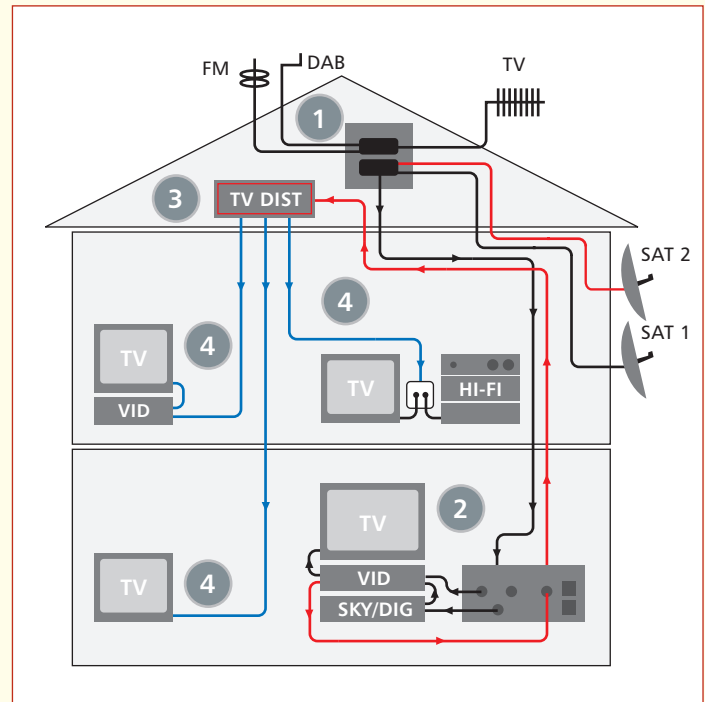

Method of installation of TV and FM aerial connection by using MK co-axial socket outlet and only one download.

Conventional distribution system for TV and FM signals using a single aerial download.

- 1 The signals from the TV and FM aerials and the satellite dish are combined together using two products. The first combines the TV and FM signals and the second adds the Sky signal to the TV/FM signal and provides a DC control path to power the LNB unit on the satellite dish. (These products are not supplied by MK).

The single aerial down lead feeds into the triplexer (black lines in wiring diagram).

- 2 The separated satellite signal is then fed to the decoder. The decoded satellite signal is then fed into the VCR along with the TV signal from the Triplexer. The output signal from the VCR then feeds into the TV and also back to the single outlet and onto the distribution amplifier (black lines in wiring diagram).
- 3 The single cable back-feed then feeds back to the input of a multi way distribution amplifier, (typically located in the loft or garage) (red lines in wiring diagram).
- 4 Each individual output from the distribution amplifier is then fed to the individual rooms in the house to a standard TV (single or diplexer) outlet to which the TV/VCR and/or Hi-Fi can be connected (blue lines in wiring diagram).



## Digital TV, Radio and Telephone Outlets

### Standards and approvals

All Logic Plus™ TV Outlets comply with BS 5733 and BS EN 50083 where applicable.

Also IEC 169-2, BS EN 60169-24 and BS 6312 part 2

Modular products are Euro compatible.

### Technical specification

#### Single Outlets

TV/FM IEC Male or Female DC-950MHz  
SAT-Type DC-1.75GHz

#### Diplexer and Triplexer products

##### TV

Diplexer: 5-65MHz  
470-862MHz  
Triplexer: 5-65MHz  
470-862MHz

##### FM

Diplexer: 87.5-108MHz  
Triplexer: 87.5-108MHz

##### SAT

Diplexer: n/a  
Triplexer: 950-2300MHz

#### TV/FM/DAB/SAT products for digital radio

##### TV

Diplexer: 5-65MHz  
470-862MHz  
Triplexer: 5-65MHz  
470-862MHz

##### FM/DAB

Diplexer: 87.5-230MHz  
Triplexer: 87.5-230MHz

##### SAT or SAT1

Diplexer: n/a  
Triplexer: 950-2300MHz

##### SAT2

Diplexer: n/a  
Triplexer: 5-2300MHz



### Description

There are two ranges of diplexer and triplexer products, an established range suitable for VHF TV, and a range suitable for digital radio (DAB).

Diplexer modules are for connecting to a single co-axial aerial down lead carrying combined TV and FM signals. The filtering in the diplexer splits out the appropriate signal and feeds it to the relevant output connection. A DC control path is provided in the TV signal path through the diplexer.

Triplexer modules are for connecting to a single co-axial aerial down lead carrying combined TV, FM and SAT signals. The filtering in the triplexer splits out the appropriate signal and feeds it to the relevant output connection. A DC control path is provided in the SAT signal path through the triplexer.

The quad outlet contains a triplexer together with a separate satellite output, for use with Sky+, or more complex installations.

Telephone secondary outlets are provided on some products for connection of telephone or for interactive TV applications.

### Features

- Non Isolated
- Fully screened
- Earth terminal provided on TV modules
- Selected products with supplementary TV outlet for back-feed for further distribution
- Selected products with BT secondary outlets for interactive TV applications

### Cable management

Logic Plus™ TV outlets can be mounted in a variety of MK trunking systems.

### BOX TYPES

	Flush	Flush (for Extra wiring space)	Surface Insulated	Surface Metal
1 gang	861ZIC	866ZIC	K2140WHI	K2211 ALM/K2213ALM
2 gang	862ZIC	886ZIC	K2142WHI	K2212 ALM/K2214ALM

Minimum recommended box depth 32mm

Note: Edge mounted modular products require 45mm box

## Digital TV, Radio and Telephone Outlets

### Dimensions (mm)

#### 1 gang (monobloc) dimensions (mm)

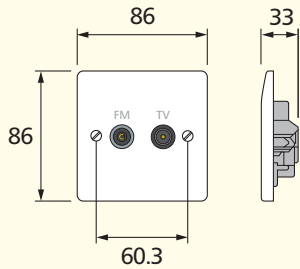

#### 2 gang (monobloc) dimensions (mm)

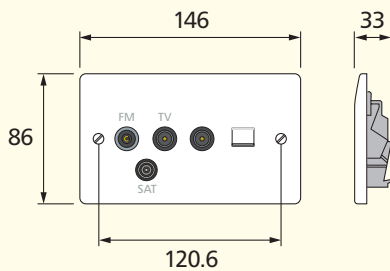

### Installation

- When installing the TV co-axial cable ensure that all cable bends are smooth so that the inner insulation is not crushed or squashed, otherwise the TV signal quality may be affected.
- Not suitable for loop-in loop-out installations.
- Use CT100 cable (or equivalent).

TV Co-axial cable stripping details

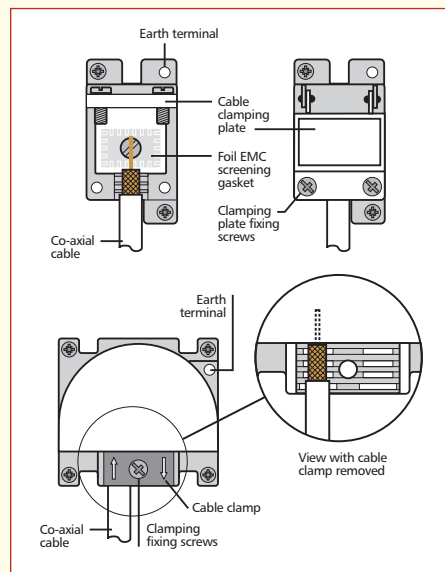
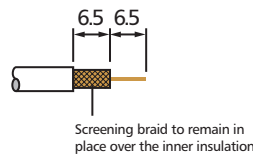

### Telephone Outlet Connection

Carefully strip 50mm of the Telephone cable outer sheath to expose the inner insulated conductors. Using the insertion tool supplied, (MK List no. 400NAT) carefully push each lead into the appropriate IDC terminals according to the wiring colour code stated in the BT Wiring Scheme diagram.

Pins 1 and 6 are frequently unused, 4 wire cable may be used in these installations.

If an existing installation uses a different wiring colour code system, this should be retained on any new or extended installation.

Additional secondary extension outlets should be wired in parallel with the existing installation via the IDC terminals, (i.e. pin 1 to pin 1, pin 2 to pin 2, etc).

In the event that the earth terminal is required to be used, the installer must ensure that a suitable earth conductor is present to connect to the earth terminal. (In the case of 2G products both TV modules should be earthed).

In the event that the earth terminal is required to be used, the installer must ensure that a suitable earth conductor is present to connect to the earth terminal. (In the case of 2G products both TV modules should be earthed).

### Telephone Wiring Scheme

- 1 GREEN / white
- 2 BLUE / white
- 3 ORANGE / white
- 4 WHITE / orange
- 5 WHITE / blue
- 6 WHITE / green

**Note:** Main wire colour is shown in capitals

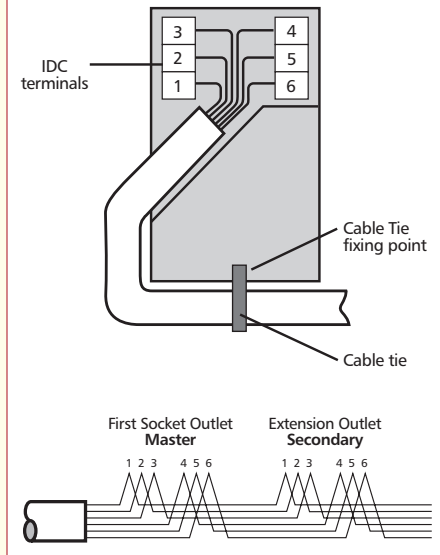

## Grid Plus Front Plates

### Standards and approvals

BS 5733: 2010

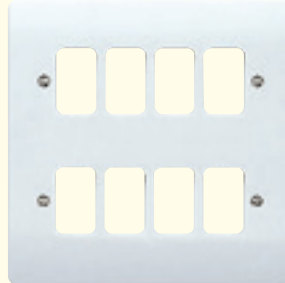

### Description

Grid Plus is a comprehensive modular switching and monitoring system ideal for a variety of applications within the commercial, public and domestic sectors.

### Dimensions (mm)

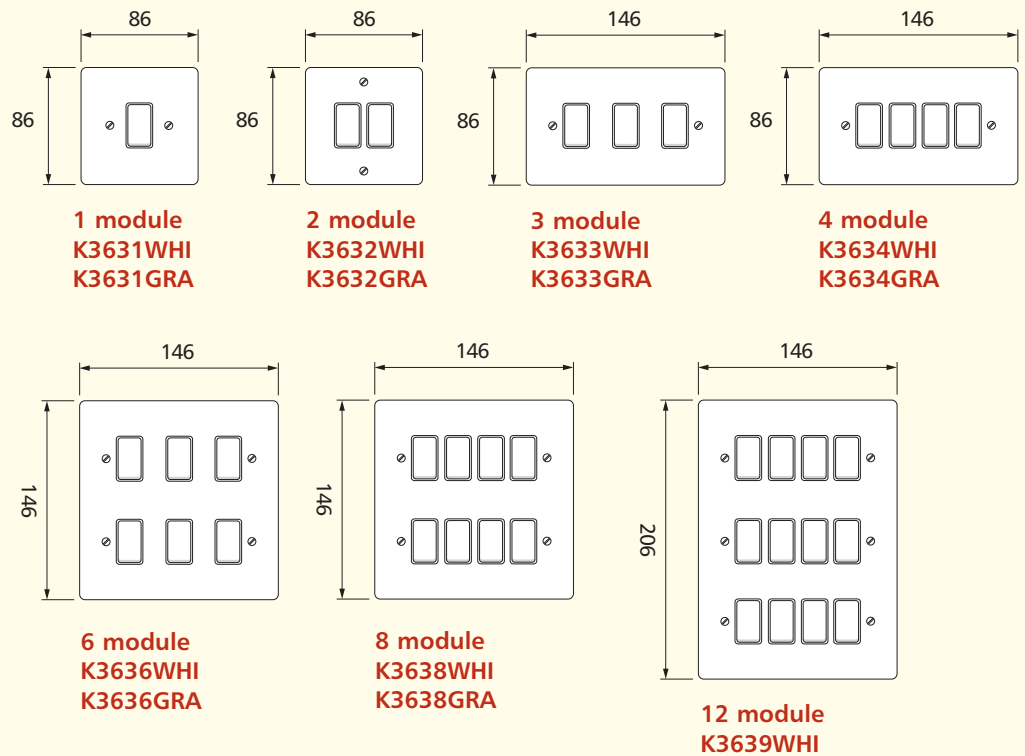

# Logic Plus Combination Plates 2/4-gang Stacked Combination Plate

## 4 Gang Plate Description

The 4-gang Stacked Combination Plate carries 2x 2-gang 13A DP switched sockets, plus a Quad TV, FM/DAB, Satellite outlet, single TV (IEC Female) and an additional Telephone socket.

Additionally, there is a 4-module Euro area capable of accommodating any additional telephone or media products from the Euro modular range.



Quad TV, FM/DAB, Satellite outlet & additional TV Socket

### Technical specification

#### Frontplate

The frontplate complies with the mechanical strength requirements of BS 5733: 2010.

#### Switched socket specification

Compliant to BS 1363 Part 2: 1995

#### Electrical

Voltage rating 250V a.c.

Current rating 13 Amp per socket outlet

#### Terminal capacity

Live, Neutral & Earth

3 x 2.5mm<sup>2</sup>

3 x 4mm<sup>2</sup>

2 x 6mm<sup>2</sup> (standard)

#### Physical

Ambient operating temperature:

-5°C to +40°C (not to exceed an average of more than 25°C in any 24 hour period)

IP rating:

IP2XD

Max. installation altitude 2000 metres

#### TV/FM/DAB/SAT products for digital radio

##### TV

Diplexer:	5-65MHz 470-862MHz
Triplexer:	5-65MHz 470-862MHz

##### FM/DAB

Diplexer:	87.5-230MHz
Triplexer:	87.5-230MHz

##### SAT or SAT1

Diplexer:	n/a
Triplexer:	950-2300MHz

##### SAT2

Diplexer:	n/a
Triplexer:	5-2300MHz

Telephone Socket  
As used on K3566WHI

4-module Euro Housing  
This portion of the plate accepts up to 4 x 50mm high by 25mm wide Euro modules. (100mm x 50mm aperture)

### Note

- Pre-configured back boxes available shall be used with these plates. These are 853ZIC, which is 35mm deep, and for greater wiring space 854ZIC, which is 47mm deep
- These back boxes should always be used to ensure alignment of the fixing screws is correct and proper segmentation between mains and low voltage products is maintained
- Mains operated products and extra low voltage modules must not be installed within the same front plate aperture. Refers to BS 7671 IEE Wiring regulations for detail
- When removing the fixing screws and front plate from an installation to gain access to low voltage modules, please be aware that there will also be access to the mains supply

## 2 Gang Plate Description

The 2-gang Stacked Combination Plate carries a 2-gang 13A DP switched sockets and an additional 4-module Euro area capable of accommodating any additional telephone or media products from the Euro modular range.

### Technical specification

#### Frontplate

The frontplate complies with the mechanical strength requirements of BS 5733: 2010.

#### Switched socket specification

Compliant to BS 1363 Part 2: 1995

#### Electrical

Voltage rating 250V a.c.

Current rating 13 Amp per socket outlet

#### Terminal capacity

Live, Neutral & Earth

3 x 2.5mm<sup>2</sup>

3 x 4mm<sup>2</sup>

2 x 6mm<sup>2</sup> (standard)

#### Physical

Ambient operating temperature:

-5°C to +40°C (not to exceed an average of more than 25°C in any 24 hour period)

IP rating:

IP2XD

Max. installation altitude 2000 metres

### Note

- Pre-configured back boxes available shall be used with these plates. These are 857ZIC, which is 35mm deep, and for greater wiring space 858ZIC, which is 47mm deep
- These back boxes should always be used to ensure alignment of the fixing screws is correct and proper segmentation between mains and low voltage products is maintained
- Mains operated products and extra low voltage modules must not be installed within the same front plate aperture. Refers to BS 7671 IEE Wiring regulations for detail
- When removing the fixing screws and front plate from an installation to gain access to low voltage modules, please be aware that there will also be access to the mains supply

## Accessories

SURFACE MOUNTING BOXES									
	16mm Moulded	30mm Moulded	32*mm Moulded	38mm PVC	40mm Moulded	41mm Steel	41*mm Steel	48*mm Steel	55mm Steel
1 gang Sockets (13A)		K2140	K2181	K2025	K2031	K2211 ALM	K2213 ALM		
2 gang Sockets		K2142	K2183		K2172	K2212 ALM	K2214 ALM	K5400	
3 gang Sockets		K2153	K2185						
2A Round Pin Sockets		K2140	K2181			K2211 ALM	K2213 ALM		
5A/15A Round Pin Sockets		K2140	K2181			K2211 ALM	K2213 ALM		
RCD Sockets					K2172	K2212 ALM	K2214 ALM	K5400	
Filtered Sockets					K2172	K2212 ALM	K2214 ALM	K5400	
Connection Units		K2140	K2181	K2025	K2031	K2211 ALM	K2213 ALM		
20A DP Switches		K2140	K2181	K2025	K2031	K2211 ALM	K2213 ALM		
K5105 32A DP Switch		K2140	K2181	K2025	K2031	K2211 ALM	K2213 ALM		
K5205, K5215 (CK & SH)					K2172	K2212 ALM	K2214 ALM		
K5230								K5400	
K5060, K5061					K2172	K2214 ALM		K5400	
K700		K2140	K2181	K2025		K2211 ALM	K2213 ALM		
K701					K2172				
1, 2 & 3 gang Switches	K2160	K2140	K2181	K2025	K2031	K2211 ALM	K2213 ALM		
4 & 6 gang Switches	K2161	K2142	K2183		K2172	K2212 ALM	K2214 ALM	K5400	
1 gang Architrave Switch	K2151								
2 gang Architrave Switch	K2152								
Dimmers using Pattress K1501, K1511, K1531, K1532	K2160								
K1521, K1534, K1533, K1535	K2160								
Dimmers not using Pattress K1501, K1511, K1531, K1532		K2140	K2181	K2025	K2031				
K1521, K1534, K1533, K1535		K2140	K2181	K2025		K2211 ALM	K2213 ALM		
K191, K192		K2140 ■	K2181	K2025		K2211 ALM	K2213 ALM		
K193, K194		K2142 ■	K2183			K2212 ALM	K2214 ALM	K5400	
Data/Telecom Plates	K2160	K2140	K2181	K2025		K2211 ALM	K2213 ALM		

■ Dependent upon modules used

\* With conduit entry knockouts

NOTE: the size of cable should be taken into consideration when choosing box depth

## Accessories

FLUSH MOUNTING BOXES								
	16mm	25mm*	27mm*	35mm*	45mm	46mm*	47mm*	55mm
1 gang Sockets (13A)		861 ZIC		866 ZIC	K2061	877 ZIC		
2 gang Sockets		862 ZIC		886 ZIC	K2062		878 ZIC	
3 gang Sockets		K863						
2A Round Pin Sockets	3995 ZIC	861 ZIC		866 ZIC	K2061	877 ZIC		
5A/15A Round Pin Sockets		861 ZIC		866 ZIC	K2061	877 ZIC		
RCD Sockets				886 ZIC	K2062		878 ZIC	
Filtered Sockets				886 ZIC	K2062		878 ZIC	
Connection Units				866 ZIC	K2061	877 ZIC		
20A DP Switches				866 ZIC	K2061	877 ZIC		
K5105 32A DP Switch				866 ZIC		877 ZIC		
K5205, K5215 (CK & SH)				886 ZIC	K2062		878 ZIC	
K5012								K5120 ALM
K5045					K2061	877 ZIC		
K5060, K5061				886 ZIC	K2061		878 ZIC	
K5011								K5120 ALM
K700		861 ZIC		866 ZIC	K2061	877 ZIC		
K701							878 ZIC	
1, 2 & 3 gang Switches	3995 ZIC	861 ZIC		866 ZIC	K2061	877 ZIC		
4 & 6 gang Switches		862 ZIC		886 ZIC	K2062			
1 gang Architrave Switch			3921 ZIC					
2 gang Architrave Switch			3922 ZIC					
Dimmers using Pattress K1501, K1511, K1531, K1532	3995 ZIC							
K1521, K1534, K1533, K1535	3995 ZIC						878 ZIC	
Dimmers not using Pattress K1501, K1511, K1531, K1532		861 ZIC		866 ZIC	K2061	877 ZIC		
K1521, K1534, K1533, K1535		861 ZIC			K2062	877 ZIC		
K191 & K192		861 ZIC ■		866 ZIC ■	K2061	877 ZIC ■		
K193 & K194		862 ZIC ■		886 ZIC ■	K2062		878 ZIC ■	
Data/Telecom Plates		861 ZIC		866 ZIC	K2061	877 ZIC		

■ Box supplied with accessory

■ Dependent upon modules used

\* With conduit entry knockouts

NOTE: the size of cable should be taken into consideration when choosing box depth