

Switchsocket Outlets

Standards and approvals

Metalclad Plus™ 13A socket outlets comply with BS 1363: Part 2: 1995.

Replacement fuses to the 3 gang socket outlets comply with BS 1362: 1973.

Technical specification

Electrical

Voltage rating:
250V a.c.

Current rating:
13A per socket outlet
(except 3 gang which is 13 amp in total)

Terminal capacity:
Live, neutral & earth
3 x 2.5mm²
3 x 4mm²
2 x 6mm² (standard)
(Dual earth terminals on list Nos.
K850, K2977, K2477, K3077, K2945, K3045)

Physical

Ambient operating temperature:
-5°C to +40°C
(not to exceed an average of more than 25°C in any 24 hour period)

IP rating:
IP2XD

Max. installation altitude:
2000 metres

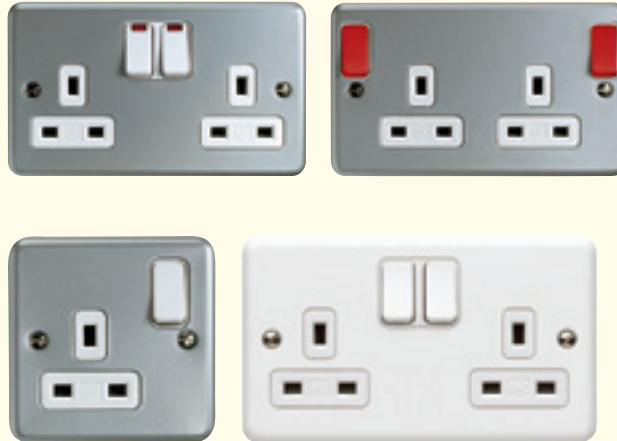

Description

A range of socket outlets designed for ease of installation and having all the advantageous design features of the Metalclad Plus™ range. The 2 gang sockets with outboard rockers are of particular value for use by the infirm and partially sighted.

Non-standard clean earth sockets are for use on installations where restricted access is required and will only accept a 647WHI 13A non-standard plug with T-shaped earth pin. The sockets have two independent earth terminals so that they can also be used for 'clean earth' installations.

A variety of sockets (see Technical specification) are fitted with two earth terminals on a common busbar to provide a double earth facility for use when installations require a high integrity protective connection as specified within BS 7671: 2008.

Round pin sockets

A range of round pin sockets is also available, switched and unswitched.

Features

- Moulded 'on' indicator flash on switches will not rub off – totally safe
- Optional neon indicators in the switch rockers with 175° visibility in the horizontal and vertical planes
- 3 pin operated safety shutter
- Printed terminal markings on grey rear mouldings for clearer identification
- Top access, angled terminals make wiring easier and quicker
- 3mm minimum switch contact gap
- Double pole switching
- Choice of inboard or outboard positioned rockers
- Additional electrical safety from neutral 'make first', 'break last' feature
- Switch contacts with silver contacts on both surfaces for good continuity
- Only one size of screwdriver required for installation
- Selection of products incorporating dual earth terminals for high integrity earthing
- Backed out and captive terminal screws
- Non-standard 'clean earth' sockets available

Socket Outlets

Installation

Metalclad Plus socket outlets can be wall or bench mounted. Do not mount or use as a trailing socket or where they may be subject to excessive moisture or dampness.

1 gang switchsocket – view from rear*

Top-facing, angled, backed-out terminals make wiring easier and quicker.



*1 gang switchsocket – view from rear

BOX TYPES			
	Flush	Flush (for extra wiring space)	Surface Metal
1 gang	861ZIC	866ZIC	as supplied
2 gang	862ZIC	886ZIC	as supplied

Dimensions (mm)

1 gang

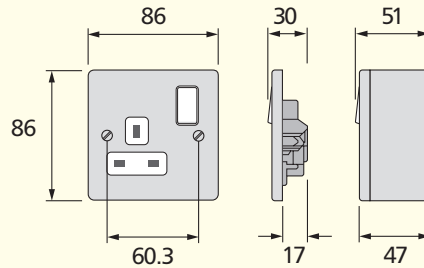

2 gang

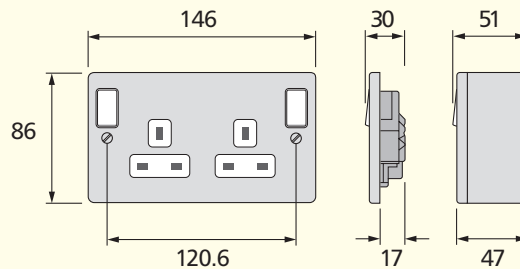
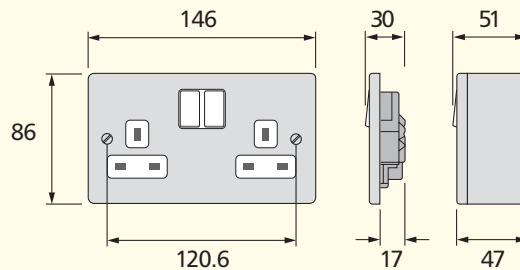

Key Operated Socket Outlet

Standards and approvals

Metalclad 13A socket outlets comply with BS 1363: Part 2: 1995

Technical specification

Electrical

Voltage rating:
250V a.c.

Current rating:
13A

Terminal capacity:
Live, neutral & earth
3 x 2.5mm²
2 x 4mm²
1 x 6mm² (stranded)
Dual earth terminals

Physical

Ambient operating temperature:
-5°C to +40°C
(not to exceed an average of more than 25°C in any 24 hour period)

IP rating:
IP2XD

Max. installation altitude:
2000 metres

Box Knockouts:
2 gang
8 x 20 dia
3 in top
2 in bottom
1 in each side
1 in base



Description

The Key Operated 13 amp socket is designed for ease of installation and has all the design features of the Metalclad Plus range. The built-in lock ensures that power cannot be provided without key operation making it ideal for public areas such as corridors. The key can be removed from the lock in the on or off position leaving the socket with or without power supply.

The product can be quickly installed as a replacement for existing flush mounted 13 amp sockets or in a new installation (assuming suitable 47mm deep mounting box is in position).

Note: The lock fitted to each socket is universal.

Features

- Backed Out, Captive Terminal Screws
- 3mm minimum gap across switch break
- Printed Terminal Markings
- Three Pin Operated Shutter
- Only one Size Screwdriver necessary for installation
- Dual Earth Terminals for high integrity earthing installations
- Key can be removed from the lock in the 'on' or 'off' positions
- Universal lock fitted to all product
- Supplied with Mounting Box

Sentrysocket RCD Protected Switchsocket Outlets

Compliance with EC Directives, Standards and approvals

All Sentrysockets comply with the following EC Directives and are CE marked:

Low Voltage Directive
Electromagnetic Compatibility Directive (89/336/EEC)

Sentrysocket RCD Sockets also comply with the requirements of the following standards:

BS 7288: 1990
BS EN 50082-1: 1998

Sentrysocket RCD Double Sockets also comply with BS EN 61543: 1996 and BS EN 55014-1.



Description

Sentrysocket provides a high level of protection against electrocution and gives further protection when used with appliances vulnerable to insulation damage, particularly when they are in damp environments or outdoors. Sentrysocket is not suitable for mounting in damp environments or outdoors.

Sentrysocket, incorporating an RCD, is part of a complete range of fixed and portable wiring devices and circuit protection devices suitable for use in domestic, commercial and industrial applications.

Active control circuit

Sentrysocket products with an active control circuit incorporate a 'Re-set' mechanism and are mains failure sensitive, i.e. they will function under all the normal conditions expected of an RCD, but will also trip in the event of a power cut or a sudden, dramatic reduction in mains voltage. This makes them ideal for use where it would be hazardous for equipment to suddenly energise after return of mains power, such as use with rotating machinery and heat developing apparatus.

Passive control circuit

Sentrysocket products with a passive control circuit incorporate a 'Stay-set' mechanism and is mains failure proof, i.e. it will function under all the normal conditions expected of an RCD and will not trip in the event of a power cut. This makes it suitable for use with freezers or in inaccessible or unmanned locations.

Technical specification

Electrical

Rated Voltage:
240V a.c.

Current rating:
13A resistive

Rated tripping current:
30mA and 10mA versions

Terminal capacity:
3 x 4mm² for 1 gang
2 x 4mm² for 2 gang

Physical

Ambient operating temperature:
-5°C to +40°C

IP rating:
IP2XD

Max. installation altitude:
2000 metres

Features

- Suitable for most residential, commercial and light industrial applications
- Active and passive control circuit applications
- Comply fully with current Wiring Regulations
- Double pole switching
- Flexible and versatile in use
- Ideal for use with equipment subject to wet weather or high humidity
- Part of a complete range of MK circuit protection devices
- They are a.c. and pulsating d.c. sensitive for residual current

BOX TYPES

Surface

Metalclad Plus	K897ALM (Spare Box)
----------------	---------------------

Metalclad Plus products have the mounting box included with the product. They are suitable for surface mounting only. Available for Single or Double Sockets.

Installation

Sentrysocket outlets can be wall or bench mounted. Do not mount or use as a trailing socket or where they may be subject to excessive moisture or dampness.

Dimensions (mm)

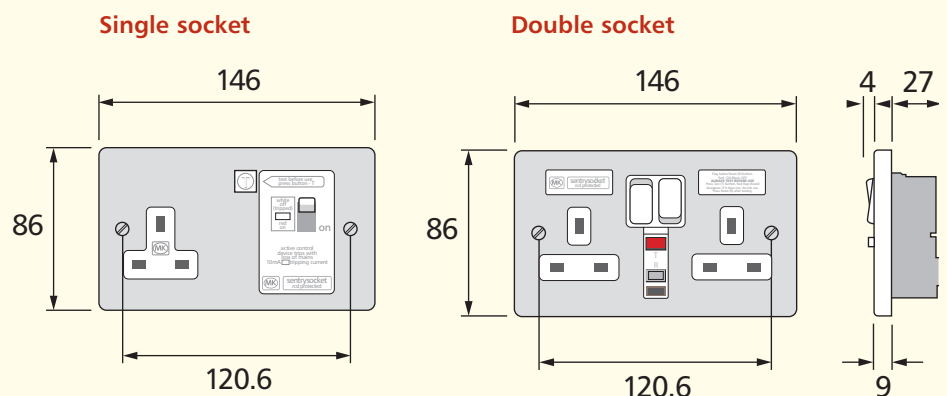

Sentrysocket

Installation

Flush mounting steel wall box

It should be noted that some of the conduit entries may be restricted, depending upon their positions and the depth of box used.

Socket Testing:

Single Socket Testing

After installation, turn the mains electricity supply on.

To test that the Sentrysocket is functioning correctly:

1. Ensure that no appliance is connected to the Sentrysocket. **Switch Sentrysocket on:** The switch should remain closed and the red flag will appear in the window. If the switch fails to remain closed, check that the Supply L and N connections are not reversed or the Supply N connection is not open circuit. If the Sentrysocket is correctly connected and still trips after being switched on, the Sentrysocket is faulty and should not be used.
2. If the Sentrysocket stays on, **press the test button:** The switch will open and the white flag will appear in the window. If the Sentrysocket does not trip and there is mains voltage present at the socket outlet, Sentrysocket is faulty and should not be used.
3. **Switch Sentrysocket on:** Connect an RCD tester and ensure that the Sentrysocket trips within the specified time:
 $\leq 200 \text{ ms AT RATED TRIP CURRENT}$
 $\leq 40 \text{ ms AT } 5 \times \text{RATED TRIP CURRENT}$
 If the Sentrysocket does not trip within the specified times then the product is faulty and should not be used (If more than one RCD is in series then there is no guarantee as to which device will trip first).
4. **Reset all tripped RCD's including the Sentrysocket.**
5. **Switch off the mains supply switch disconnecter.** On mains failure, a Sentrysocket with Active Control Circuit will trip, whilst a Sentrysocket with Passive Control Circuit will not trip. If the Active Control device does not trip, it is faulty and should not be used – see note below. If no faults have been found then installation testing has been completed successfully.

Note: If a fault is identified at any stage of installation testing procedure do not use Sentrysocket, and contact your local electrician, or your local MK stockist.

Double Socket Testing

After installation, turn the mains electricity supply on.

To test that the Sentrysocket is functioning correctly follow the steps 1 to 4 below:

1. Ensure that no appliance is connected to the Sentrysocket.
2. **Reset** – Press the button marked R (for Reset) – the contact status indicator should show red, indicating that the socket outlets are now live (if the switches are in the ON positions).
3. **Test** – Press the TEST button marked T (for Test), the product should trip with the contact status indicator showing black. In this state the socket outlets are disconnected from the supply.
4. **Reset** – Press the button marked R again, the contact status indicator should show red.
5. Connect an RCD Tester to either socket outlet and ensure that the Sentrysocket trips with the specified times below:
 $\leq 200 \text{ ms AT RATED TRIP CURRENT}$
 $\leq 40 \text{ ms AT } 5 \times \text{RATED TRIP CURRENT}$
6. Reset the Sentrysocket as in step 2 above.
7. Switch off the Mains Supply Switch Disconnecter.
8. A Sentrysocket with Active Control Circuit should trip while a Sentrysocket with Passive Control Circuit should not trip.

If all the operations in steps 2 to 8 above give correct results, the Sentrysocket RCD socket outlet is safe to use.

If the procedures in steps 2 to 8 above are not completed correctly, do not use the Sentrysocket product and seek professional advice or contact the MK Technical Sales and Service department on +44 (0)1268 563720.

Round Pin Socket Outlets

Standards and approvals

Round pin socket outlets comply with BS 546: 1950.

Technical specification

Electrical

Voltage rating:
250V a.c.

Terminal capacities:
2 amp sockets (K841):
7 x 1mm²
4 x 1.5mm²
2 x 2.5mm²
1 x 4mm²

5 amp sockets (K842):
3 x 2.5mm²
2 x 4mm²

15 amp sockets (K843):
3 x 2.5mm²
3 x 4mm²
2 x 6mm² (stranded)

Physical

Ambient operating temperature:
-5°C to +40°C
(not to exceed an average of more than 25°C in any 24 hour period)

IP rating:
IP2XD

Max. installation altitude:
2000 metres



Description

A range of round pin socket outlets designed for ease of installation and having all the advantages and design features of the Metalclad Plus range. These products can be quickly installed as replacements for existing socket outlets or in new installations.

Features

- Top access terminals make wiring easier and quicker
- Integral ON indicator on switches will not rub off – totally safe
- 3mm minimum switch contact gap
- Double pole switching
- Terminal screws backed out
- Additional electrical safety from neutral “make first”, “break last” feature on switched sockets
- Switch contacts with silver contact points on both surfaces for good continuity
- 5A and 15A sockets contain a 3 pin operated safety shutter
- Printed terminal markings on grey rear mouldings for clearer identification
- 2A socket shuttered

Installation

Metalclad Plus socket outlets can be wall or bench mounted – do not mount or use as a trailing socket or where they may be subjected to excessive moisture or dampness.

Cable management

Metalclad Plus socket outlets can be mounted in a variety of MK trunking systems.

Dimensions (mm)

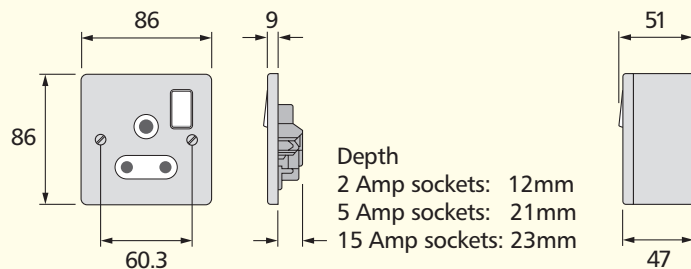

15A American Socket Outlet

Standards and approvals

Complies with SASO 2203: 2003

Technical specification

15A American

Electrical

Voltage rating:
127V a.c.

Current rating:
15A

Terminal capacity:
Live, neutral & earth
3 x 2.5mm²
2 x 4mm²
1 x 6mm² (stranded)

Physical

Ambient operating temperature:
-5°C to +40°C
(not to exceed an average of more than 25°C in any 24 hour period)

IP rating:
IP2XD

Max. installation altitude:
2000 metres



Dimensions (mm)

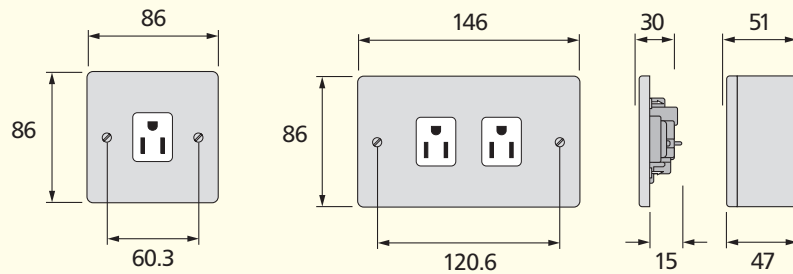

Installation

Metalclad Plus socket outlets can be wall or bench mounted. Do not mount or use as a trailing socket or where they may be subject to excessive moisture or dampness.

technical hotline +44 (0)1268 563720

surface | wiring devices

Connection Units and 20A DP Switches

Standards and approvals

Connection Units comply with BS 1363 Part 4: 1995.

20A DP switches comply with BS EN 60669-1: 1999.

Fuses are to BS 1362.

Technical specification

Electrical

Voltage rating:
250V a.c.

Current rating:
Connection units – 13 amp
DP switches – 20 amp

Terminal capacity:

Supply terminal: 2 x 6mm² stranded
 2 x 4mm²
 3 x 2.5mm²

Load terminals: 2 x 6mm² stranded
 2 x 4mm²
 3 x 2.5mm²

Flex Outlet

Cord grip capacity:

Connection units: min: 2 core, 0.5mm
 max: 3 core, 1.5mm

20 amp DP switches: min: 3 core, 1.5mm
 max: 3 core, 2.5mm

Physical

Ambient operating temperature:
–5°C to +40°C
(not to exceed an average of more than 25°C
in any 24 hour period)

IP rating:

With flex outlet: IP2XD
Without flex outlet: IP4X

Max. installation altitude:
2000 metres

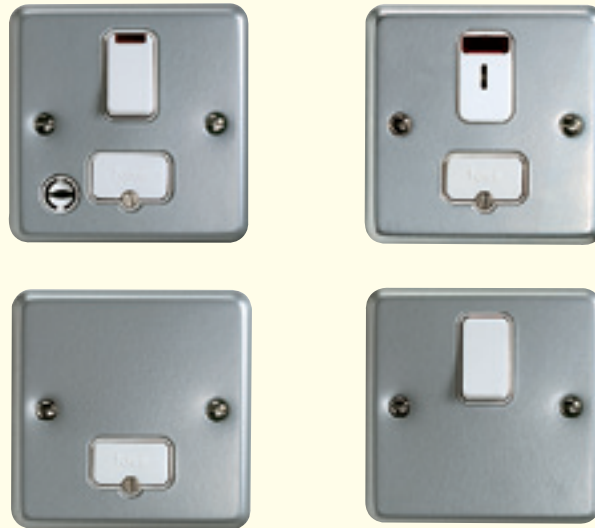

Description

A range of 13A fused connection units and 20A DP switches designed for the connection of refrigerators, water heaters, central heating boilers and other fixed appliances.

The ranges are designed for ease of installation and have the advantageous design features of the Metalclad Plus range.

Neon indicators

Neon indicators can be included in the rockers of the switched connection units. In the case of unswitched units, they are located centrally and uppermost on the face plate. Neon indicators are integrally wired into the product and do not require separate connection when installing.

The design gives 175° visibility in the horizontal and vertical planes.

Fuse carriers

These are captive and are opened by a fast acting, screwdriver operated worm drive for ease of replacement.

A tamper-proof version is also available.

Fuse carriers can be locked open using a padlock, List No. K2000.

Flex outlets

The products are equipped with very strong, push-fit nylon cord grips making installation safe, quick and easy.

Connection Units and 20A DP Switches

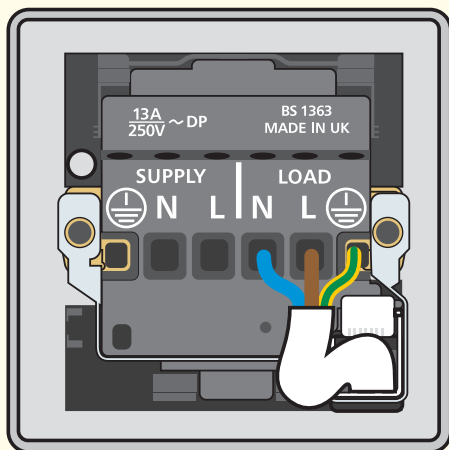

Front outlet cord grip

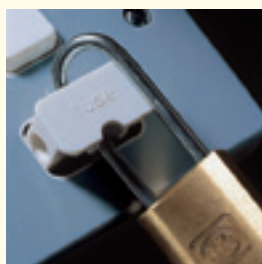

Lockable fuse carrier

Installation

Metalclad Plus connection units and 20A cable outlets and switches can be wall or bench mounted. Do not use on a trailing lead.

Wiring

Products must be installed in accordance with current IEE Regulations.

Features

- Optional indicators in the switch rockers with 175° visibility in the horizontal and vertical planes
- Worm-drive operated fuse carriers for additional security (tamper-proof version available)
- Fuse carrier lockable in open position
- All supply and load cables can be cut and stripped to the same length
- Integrally wired indicators save installation time
- Push-fit cord grips, for safer, quicker installation
- Angled, top mounted terminal screws simplify wiring
- Moulded 'on' indicator flash on switches cannot rub off – totally safe
- Captive fuse carrier
- Additional electrical safety from neutral 'make first', 'break last' feature
- Secure cable and flexible cord connection
- All terminal and fixing screws operated by one-size (4mm) screwdriver
- Backed out and captive terminal screws

Box types

Supplied with a box having 2 x 20 mm knockouts in one side, as well as 1 x 20 mm knockouts in each of the other three sides and the bottom of the box.

Spare boxes are available without side knockouts (K829 ALM).

All boxes have a knockout in the base.

Dimensions (mm)

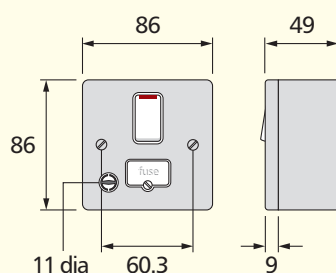

Plateswitches

Standards and approvals

All Metalclad Plus plateswitches comply with BS EN 60669-1: 1999.

Technical specification

Electrical

Voltage rating:
250V a.c. 50Hz

Current rating:
10 amps – no derating when used on fluorescent or inductive loads

Terminal capacity:

All products –
4 x 1mm²
4 x 1.5mm²
3 x 2.5mm²
2 x 4mm²
1 x 6mm²

Contact gap:
3mm switch contact gap

Physical

Operating temperature:
–5°C to +40°C

IP rating:
IP4X

Max. installation altitude:
2000 metres

Operational testing (all plate switches):
tested to 100,000 operations for mechanical life
tested to 30,000 operations at 10 amp rating



Description

A comprehensive range of tough, impact resistant, surface mounted plateswitches. They have been designed to suit a wide variety of applications in factories, workshops, plant rooms, warehouses, schools and hospitals.

The frontplate has smooth chamfered edges engineered to fit flush with the backbox.

Backboxes with or without side knockouts are available and all have a central knockout in the base.

Wide rocker switches are also available.

Features

- Two way switches can be wired as one or two way
- All products clearly printed with BS Nos., ratings, etc
- Matching Grid switches available in 10 or 20A ratings
- 3mm switch contact gap
- Positive switch action
- Top access, backed out and captive terminal screws
- Metalclad Plus is supplied with white inserts only
- An earth terminal is provided attached to rear of product and in base of mounting box

BOX TYPES

	Flush	Surface
All 1,2 and 3 gang switches	3995ZIC	K2160WHI

All these products are designed primarily for surface mounting and are supplied complete with mounting box. If flush mounting is required then recommended box is 3995ZIC 16mm deep.

Plateswitches

Dimensions (mm)

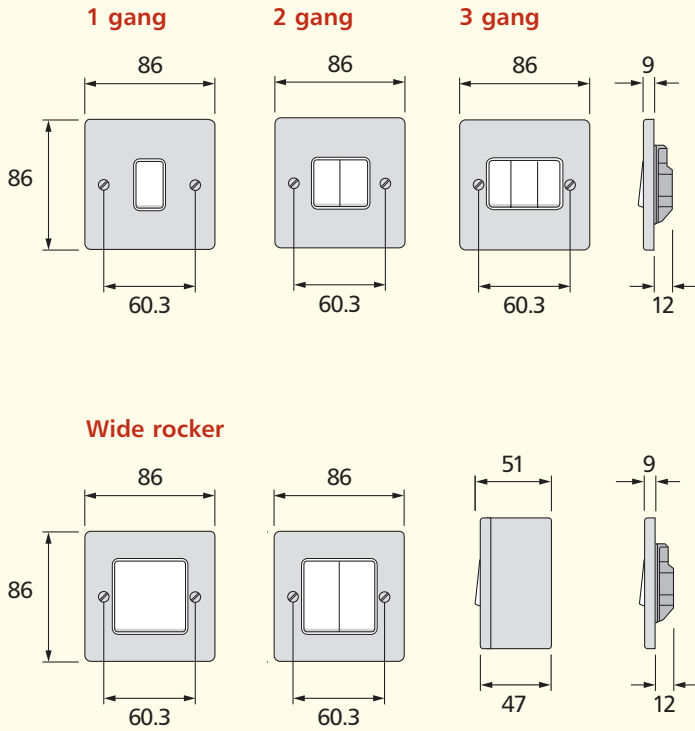

Wiring Diagrams

One-way switching

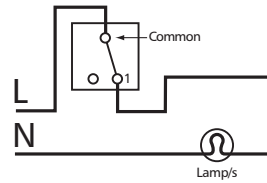

Two-way switching – 2 wire control

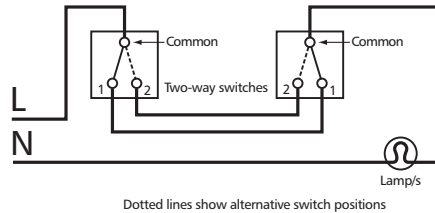

Two-way switching plus intermediate switching – 2 wire control

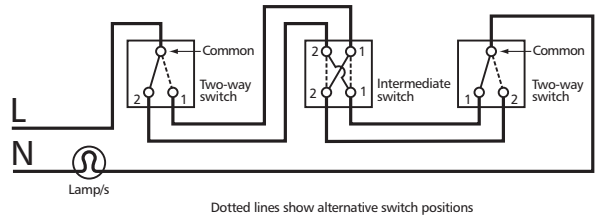

Two-way switching – 3 wire control

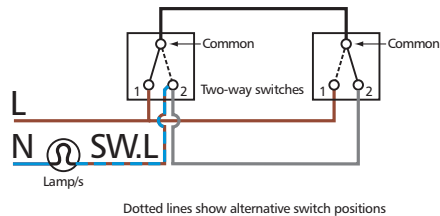

Two-way switching plus intermediate switching – 3 wire control

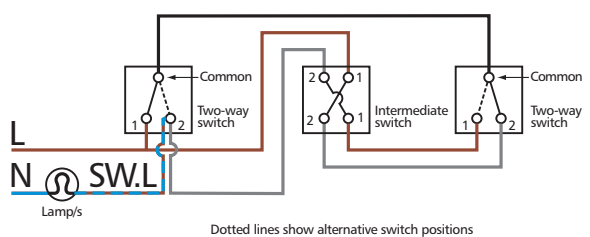

N.B. Terminal positions may alter. The above diagrams are to show wiring layout.

Key Operated Switch

Standards and approvals

All DP switches in the range conform to BS EN 60669-1: 1999.

Technical specification

Electrical

Voltage rating:
250V a.c. 50Hz

Current rating:
20 amps

Terminal capacity:
All products –
4 x 1mm²
4 x 1.5mm²
3 x 2.5mm²
2 x 4mm²
1 x 6mm²

Contact gap:
3mm switch contact gap

Physical

Operating temperature:
-5°C to +40°C

IP rating:
IP4X

Max. installation altitude:
2000 metres



Description

Lockable additions to the extensive Metalclad Plus range of products.

Features

- 20A DP Key Operated Switch
- Complies with BS EN 60669-1 and should not be used as an isolator
- Backed Out, Captive Terminal Screws
- 3mm minimum gap across switch break
- Printed Terminal Markings
- Only one Size Screwdriver necessary for installation
- Key can be removed from the lock in the 'on' or 'off' position
- Universal lock fitted to all products
- Supplied with Mounting Box

High Current Switches

Standards and approvals

All DP switches in the range conform to BS EN 60669-1: 1999.

Technical specification

Electrical

Voltage rating:
250V a.c.

Current:
32A Switch
50A Switch (resistive)

Switch:
3mm contact gap
Double pole operation

Terminal capacity, 45A Switches
4 x 4mm²
3 x 6mm²
1 x 16mm²

Terminal capacity, 32A Switch:
3 x 2.5mm²
2 x 4mm²
1 x 6mm²

Physical

Ambient operating temperature:
-5°C to +40°C
(not to exceed an average of more than 25°C in any 24 hour period)

IP rating:
IP4X

Max. installation altitude:
2000 metres



Description

A range of switches and cooker control units harmonising with the Metalclad Plus style, suitable for the switching of all domestic, commercial and industrial appliances where higher current ratings are required, i.e. cookers, heaters etc. Metal units are particularly suitable for refurbishment projects.

Features

- Positive switch action
- Positive double pole switching
- Toggle action switches
- Very robust paint finish
- Metal frontplates
- Replaceable neon indicators

Note: These switches are not recommended for switching large banks of PCs

Box types

32A switch supplied with a box having 2 x 20mm knockouts in one side, as well as 1 x 20mm knockout in each of the other three sides and the bottom of the box.

50A switch supplied with a box having 3 x 20mm knockouts in one of the long sides and 2 x 20mm knockouts in the other. Both short sides and the bottom of the box have 1 x 20mm knockout.

Spare boxes are available for both size of product with no knockouts in any of the sides (K829ALM for 32A, K830ALM for 50A). A knockout is retained in the bottom of each box.

BOX DEPTHS			
List No.	Max. cable size	Flush	Surface
Switches			
32A	10mm ²	46mm	40mm
50A	10mm ²	47mm	40mm

BOX REFERENCES		
Flush	32A	50A
Box depth		
46mm	877ZIC	–
47mm	–	878ZIC

Dimensions (mm)

K5240

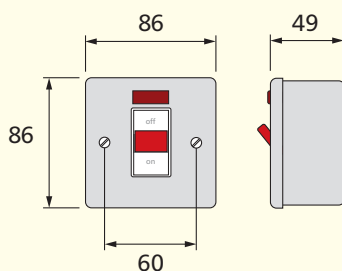

K5230

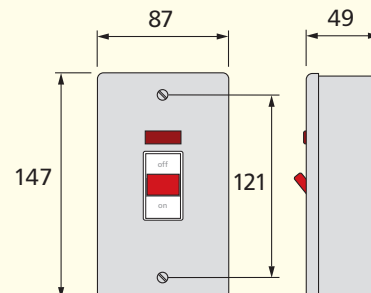

Three Pole Fan Isolators

Standards and approvals

Comply with BS EN 60947: 1992.

Technical specification

Electrical

Voltage rating:
250V a.c. 50Hz

Current rating:
10 amps

Terminal capacity:
4 x 1mm²
4 x 1.5mm²
3 x 2.5mm²
2 x 4mm²
1 x 6mm²

Contact gap:
4mm switch contact gap

Classifications

Method of operation: Stored energy operation
Suitability for isolation: Suitable for isolation

Ratings

Utilisation category	AC23B
Rated operational voltage (Ue)	250V
Conventional free air thermal current (Ith)	10A
Rated frequency	50Hz
Rated making capacity	100A rms
Rated breaking capacity	80A rms
Rated conditional short-circuit current	6000A rms
(with supply side protective device GEC NIT 16 BS88: part 2: 1988 16A 550VAC utilisation category gG 80KA breaking capacity fuse links.)	

Physical

Operating temperature:
-5°C to +40°C

IP rating:
IP4X

Max. installation altitude:
2000 metres



Description

The MK Three Pole Fan Isolator provides a safe and simple method of isolating mechanical fan units and is particularly useful in bathrooms, toilets, storerooms and basements where there is little or no natural light.

For example, timer controlled fans are often linked into the lighting circuit for energy saving and convenience. In such an installation there is often a need for the lighting circuit to remain live to provide light whilst the fan unit is externally isolated so that routine maintenance and repairs can be carried out in complete safety.

The K2857 fan isolator can be used as a double pole or triple pole isolator. In addition it includes a clear on/off indicator and the frontplate features a fan isolator symbol for easy circuit identification.

Dimensions (mm)

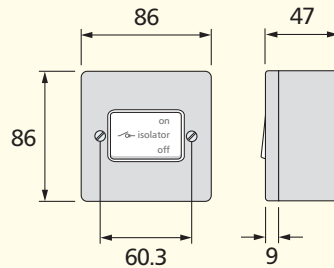

Features

- Switchlock list no. K4858 is available to allow the isolator to be locked in the disconnected position to facilitate fan maintenance

Three Pole Fan Isolators

Wiring Diagrams

Two pole switching for fan units without timers

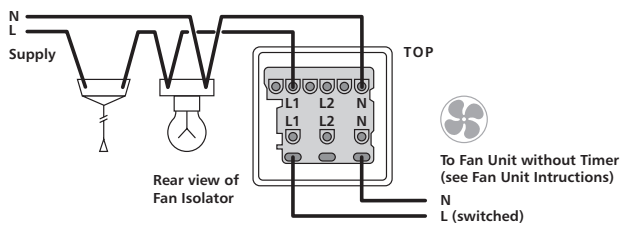
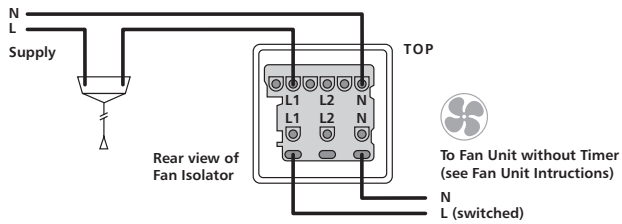

Three pole switching for fan units incorporating timers

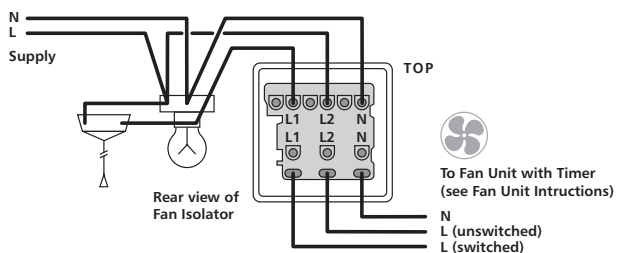
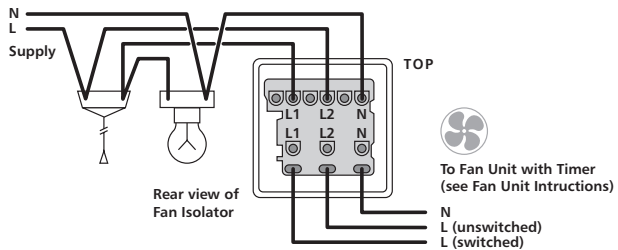

Euro and LJU6C Data Frontplates

Standards and approvals

BS 5733: 2010

Technical specification

Dimensions

Height: 86mm
 Width: 86mm (1G)
 146mm (2G)
 Depth: 9mm

Aperture Dimensions (Nominal)

Euro Frontplates

Height: 50mm
 Width: 50mm (1G)
 100mm (2G)

LJU6C Frontplates

Height: 37mm
 Width: 22mm

Features

- 1G and 2G Euro frontplates
- 1G LJU6C frontplate
- Metalclad Plus style
- Accept industry standard Euro or LJU6C snapfit modules
- K181 Euro frontplate accepts 1 Euro module, (25 x 50mm aperture)
- K182 Euro frontplate accepts 2 Euro modules, (50 x 50mm aperture)
- K184 Euro frontplate accepts 4 Euro modules, (100 x 50mm aperture)
- K172 LJU6C frontplate accepts two LJU6C modules (27 x 37mm apertures)
- 1/2 module (12.5 x 50mm) blank available for Euro frontplates
- Interchangeable modules clip into front-plate



Description

Frontplates used for mounting snapfit data modules.

Dimensions (mm)

Euro Frontplates

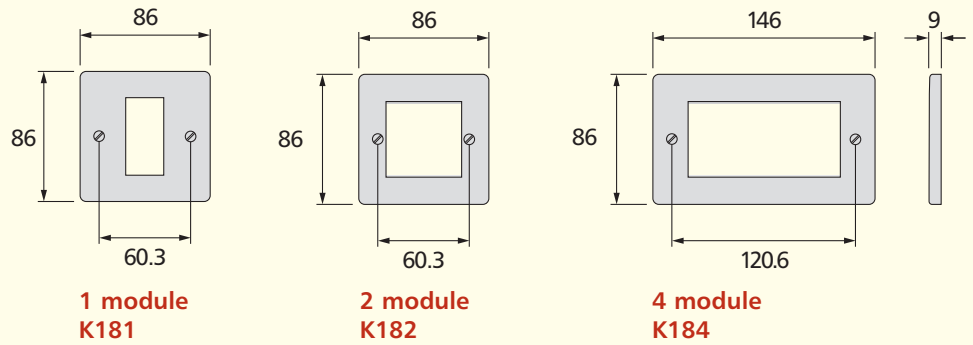

LJU6C Frontplates

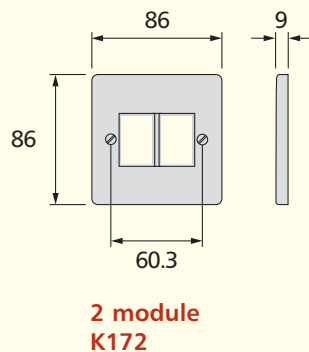

RJ45 Data Outlets

Standards and approvals

ISO/IEC 11801
 EN 50173
 TIA 568
 EN 41003



Description

Suitable for use in all LU6C, Euro and MK Modular frontplates, available in the Logic Plus range, Cat 5e and Cat 6 modules suitable for use in structured cabling distribution systems.

Installation

- Maximum cable length 90m.
- Cable bend radii, 40mm during installation, 20mm after installation.
- Maximum pull force 8.7kg.
- Do not over tighten cable ties.
- Do not unwind the twists in the wire pairs by more than 13mm max.

Installation details and wiring diagram illustrations

TIA WIRING SCHEME COLOUR CODES:

Pin No.	568A	568B
1	WHITE / green	WHITE / orange
2	GREEN / white	ORANGE / white
3	WHITE / orange	WHITE / green
4	BLUE / white	BLUE / white
5	WHITE / blue	WHITE / blue
6	ORANGE / white	GREEN / white
7	WHITE / brown	WHITE / brown
8	BROWN / white	BROWN / white

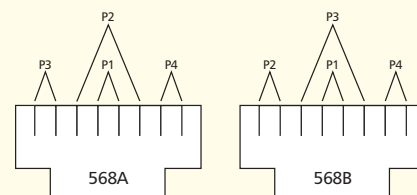

Pair 1 – BLUE/white & WHITE/blue
 Pair 2 – ORANGE/white & WHITE/orange
 Pair 3 – GREEN/white & WHITE/green
 Pair 4 – BROWN/white & WHITE/brown

Euro and LU6C modules are to be wired as follows

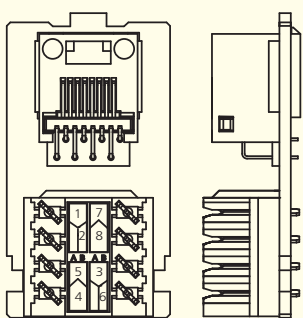

RJ45 Cat.5e Euro K5845

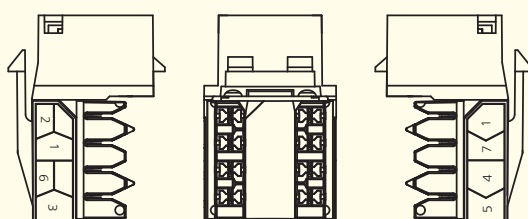

RJ45 Cat.5e Euro - Angled K5844

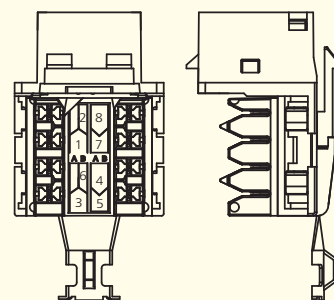

RJ45 Cat.6 Screened
 K5746S - LU6C, K5846S - Euro

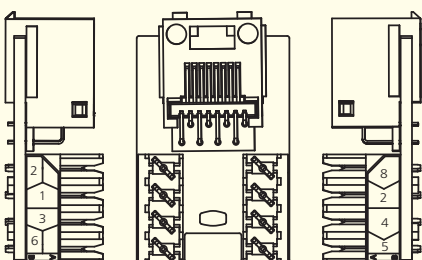

RJ45 Cat.5e LU6C K5745

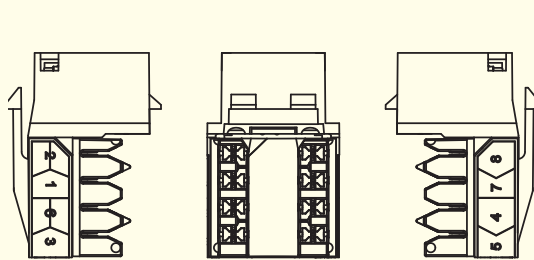

RJ45 Cat.6 Euro - Angled K5746 - LU6C
 K5846 - Euro, K5864 - Euro Angled

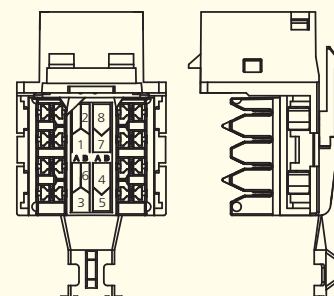

RJ45 Cat.5e Screened
 K5845S - Euro

Telephone, RJ11/12, BNC Data and Blank Modules

Standards and approvals

Telephone sockets K5820 and K5821 comply with the following:

BS 6312: 2.2

Data sockets K5801, BS 5733: 2010 (where applicable).

K5887 complies with FCC68 and EN 41003.



Technical specification

Electrical

Cable types:

Telephone: CW1311, CW1293, CW1308, CW1316

No. of cables per termination:

Telephone: 2

RJ11/12: 1

BNC

50 Ohms impedance cable – RG58, RG141, URM43

Belden 9907

Frequency range:

BNC connector: 0 to 4GHz

Impedance:

BNC Connector: 50. nominal

Termination type:

Telephone module – IDC

BNC module – Crimped connection

Physical

Temperature range:

Ambient air –20°C to +60°C

IP rating:

IP2XD – K5820, K5821, K5801 and K5787.

IP4X – K180, K188, K186 and K170

Max. installation altitude:

2000 metres

Description

A range of telephone, data and blank modules to fit Euro and U6UC front plates. BNC Euro modules with a 50Ohm crimp connector suitable for use with RG58, URM43, URM76 and Belden 9907 type co-axial cables are also available.

Installation (Telephone socket modules)

Product performance, systems compatibility

Master Sockets: For use as the first socket outlet on a direct exchange. They contain the required surge protector (for line protection against electrical surges) and ringing capacitor.

Secondary Sockets: for use as extension sockets when connected on the same line as a Master Socket.

Installation tools required IDC Connectors (telephone & RJ45 outlets)

MK insertion tool List No. 400NAT.

Wire pull-out force: 10.5 Newtons when installed correctly.

Wiring regulation restrictions

Domestic Installations: The total REN (Ring Equivalent Number) value of all telephone equipment connected on a line must not exceed 4.

Features

- Meet all relevant BS, OFTEL and cabling standards
- Interchangeable modules clip into frontplates
- Front fixing facilitates easy exchange of modules
- Part of a complete range of products for telephone and data processing requirements
- Can be specified for all applications

Data sockets

- Latest specification for high performance systems
- Made to stringent quality assurance procedures
- Wide range of data connectors available

Telephone sockets

- 100% tested before delivery
- Quick, simple and reliable IDC connectors

For information on TV Satellite and FM Modules see pages 613-614.

Telephone, RJ11/12, BNC Data and Blank Modules

Telephone Wiring Scheme

- 1 GREEN / white
- 2 BLUE / white
- 3 ORANGE / white
- 4 WHITE / orange
- 5 WHITE / blue
- 6 WHITE / green

Note: Main wire colour is shown in capitals

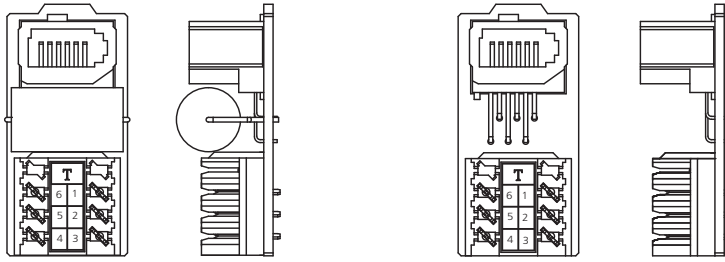

K5820

K5821

First Socket Outlet
Master

Extension Outlet
Secondary

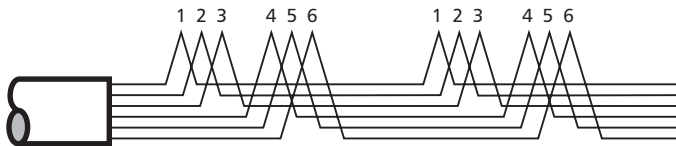

RJ11/12 Wiring Scheme

PIN NO.	STRIPPED COLOUR WIRE	SOLID COLOUR WIRE
1	WHITE / green	WHITE
2	WHITE / orange	BLACK
3	BLUE / white	RED
4	WHITE / blue	GREEN
5	ORANGE / white	YELLOW
6	GREEN / white	BLUE

Note: Main wire colour is shown in capitals

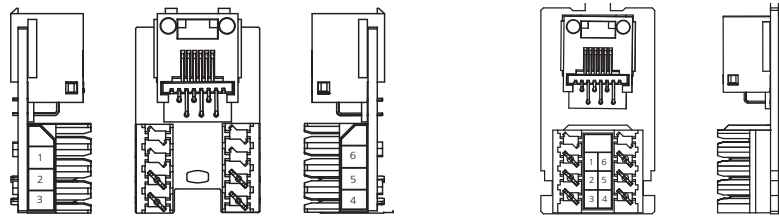

K5787

K5887

Digital TV and Radio Outlets

Standards and approvals

All MK Digital TV Outlets comply with BS 5733 and BS EN 50083 where applicable.

Also IEC 169-2, BS EN 60169-24 and BS 6312 Part 2.

Modular products are Euro compatible.



Technical specification

Single Outlets

TV/FM IEC Male or Female DC-950MHz
SATF-Type DC-1.75GHz

Diplexer and Triplexer products

TV

Diplexer: 5-65MHz
470-862MHz
Triplexer: 5-65MHz
470-862MHz

FM

Diplexer: 87.5-108MHz
Triplexer: 87.5-108MHz

SAT

Diplexer: n/a
Triplexer: 950-2300MHz

TV/FM/DAB/SAT products for digital radio

TV

Diplexer: 5-65MHz
470-862MHz
Triplexer: 5-65MHz
470-862MHz

FM/DAB

Diplexer: 87.5-230MHz
Triplexer: 87.5-230MHz

SAT or SAT1

Diplexer: n/a
Triplexer: 950-2300MHz

SAT2

Diplexer: n/a
Triplexer: 5-2300MHz

Description

There are two ranges of diplexer and triplexer products, an established range suitable for VHF TV, and a range suitable for digital radio (DAB).

Diplexer modules are for connecting to a single co-axial aerial down lead carrying combined TV and FM signals. The filtering in the diplexer splits out the appropriate signal and feeds it to the relevant output connection. A DC control path is provided in the TV signal path through the diplexer.

Triplexer modules are for connecting to a single co-axial aerial down lead carrying combined TV, FM and SAT signals. The filtering in the triplexer splits out the appropriate signal and feeds it to the relevant output connection. A DC control path is provided in the SAT signal path through the triplexer.

The quad outlet contains a triplexer together with a separate satellite output, for use with Sky+, or more complex installations.

Installation

- When installing the TV Co-axial cable ensure that all cable bends are smooth so that the inner insulation is not crushed or squashed. Otherwise the TV signal quality may be affected.
- Not suitable for loop-in loop-out installations
- use CT100 cable (or equivalent.)

Dimensions (mm)

Euro 2 module (monobloc)

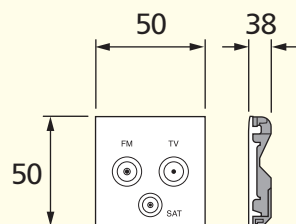

Euro 1 module (monobloc)

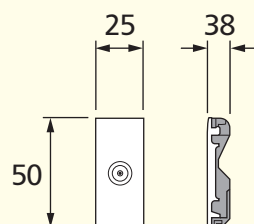

Features

- Non Isolated
- Fully screened
- Earth terminal provided on TV modules

Cable management

Digital TV outlets can be mounted in a variety of MK trunking systems.

Note: Minimum box depth: 47mm

TV Co-axial cable stripping details

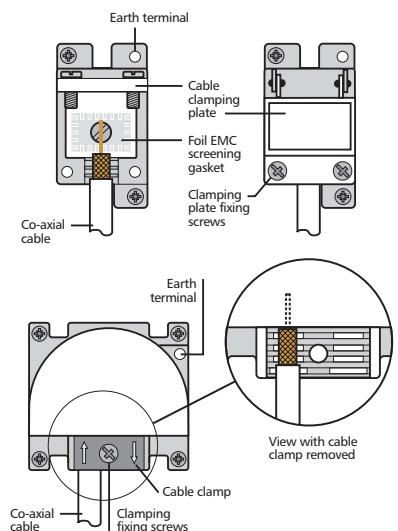
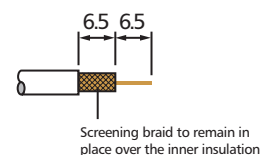

MK Modular Datacoms

Standards and approvals

Metalclad Telephone and Data sockets comply with the following:

Telephone sockets K452 and K457

BS 6312: 2.2, OFTEL Approval NS/G/23/L/100005

Data sockets K290, K451, K452, K455, K457, K458

BS 5733: 2010 (where applicable)

Data sockets K455

Cat 5e performance to EIA/TIA TSB568, BS EN 50173, IEC11801



Technical specification

Electrical

Cable types:

Telephone CW1311, CW1293, CW1308, CW1316

RJ45: 20 to 26 AWG, 100 ohm Cat 5e UPT cable

No. of cables per termination (Telephone & RJ45):

Telephone: 2

RJ45: 1

Termination type:

RJ45 & telephone module – IDC

Physical

Temperature range:

Ambient air -20°C to +60°C

IP rating:

IP2XD

Max. installation altitude:

2000 metres

Description

A unique modular system in the distinctive Metalclad Plus style comprising a range of socket modules for Data and Telephone use, with 4 to 2 matching frontplates capable of accepting combinations of interchangeable modules. Modules clip into mounting frames which, when attached to frontplates, provide a high degree of versatility, making the system ideal for use in all commercial and industrial applications.

Features

- Meet all relevant BS, OFTEL and cabling standards
- Part of a range of products for telephone and data processing requirements
- Interchangeable modules clip into grid frame which attaches to frontplate

Telephone sockets and frontplates

- Quick, simple and reliable IDC connectors
- Can be specified for all applications

Data sockets and frontplates

- Cat 5e specification performance
- Made to stringent quality assurance procedures

Dimensions – Data and TV modules (mm) (Minimum box depth 16mm)

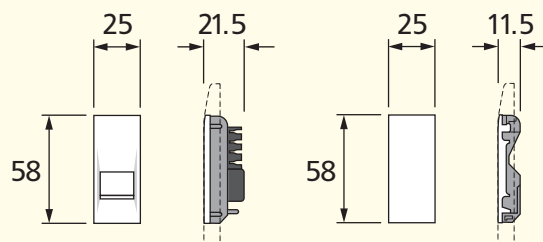

**K455 / K452 /
K457 / K458**

K290

MK Modular Datacoms

Dimensions – Modular frontplates (mm)

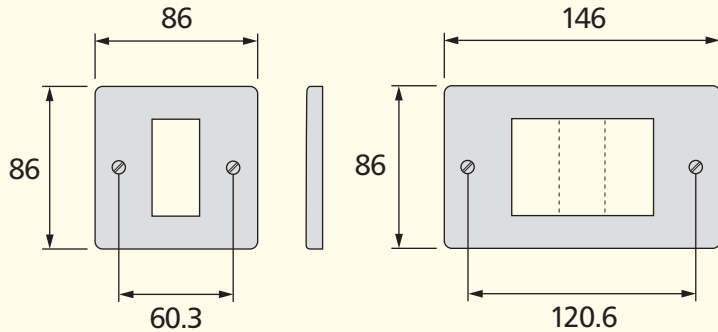

1 module
K291

3 module
K293

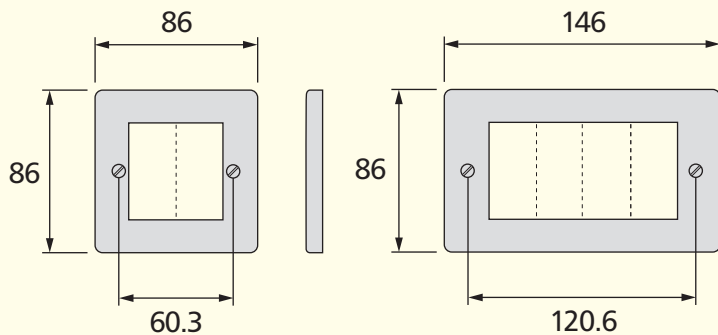

2 module
K292

4 module
K294

RJ11 Wiring Scheme

PIN NO.	STRIPPED COLOUR WIRE	SOLID COLOUR WIRE
1	WHITE / green	White
2	WHITE / orange	Black
3	BLUE / white	Red
4	WHITE / blue	Green
5	ORANGE / white	Yellow
6	GREEN / white	Blue

Note: Main wire colour is shown in capitals

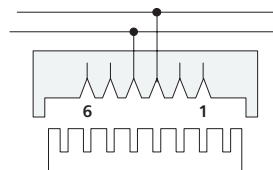

Rear View of Terminal
Connection Block

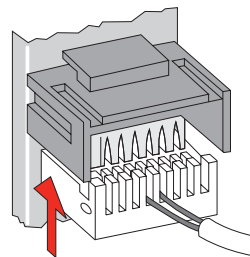
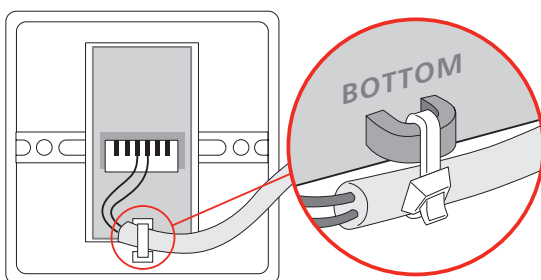

Installation (Data sockets)

RJ45 modules

In order to maintain Category 5e performance, install cabling in accordance EIA/TIA or ISO General Cabling Standards.

Installation (Telephone socket modules)

Product performance, systems compatibility

Master Sockets: For use as the first socket outlet on a direct exchange. They contain the required surge protector (for line protection against electrical surges) and ringing capacitor.

Secondary Sockets: for use as extension sockets when connected on the same line as a Master Socket.

Installation tools required IDC Connectors (telephone & RJ45 outlets)

MK insertion tool List No. 400 or 22630.

Wire pull-out force: 10.5 Newtons when installed correctly.

Wiring regulation restrictions

Domestic Installations: The total REN (Ring Equivalent Number) value of all telephone equipment connected on a line must not exceed 4.

Industrial and commercial installations: MK telephone sockets are suitable in all situations after the PBX/PABX has been installed by a recognised installer. For key systems and other 'special' systems, the manufacturer's instructions should be referred to.

Safety information

None of the above products should be installed into the same fixing or mounting boxes as mains rated equipment or cable.

Note: For Telephone and RJ45 wiring scheme diagrams see pages 611-612.

Cable management

Metalclad Plus Modular Data and Telephone Sockets can be mounted in a variety of MK trunking systems. See main catalogue for further details.

Grid Plus Front Plates

Standards and approvals

BS 5733: 2010

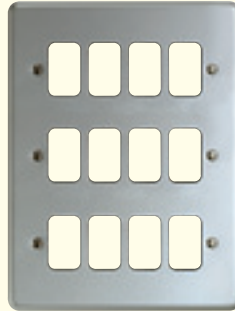

Description

Grid Plus is a comprehensive modular switching and monitoring system ideal for a variety of applications within the commercial, public and domestic sectors.

Dimensions

