

Modular Switching System

Standards and approvals

Switch modules

BS EN 60669-1: 1999

Indicator units

BS 5733:2010

Dimmer switches

Dimmers comply with IEC 669-2-1, BS EN 55015

Accessory modules

Single non-isolated, TV/FM socket outlet,
BS 3041 Part 2: 1977

Universal Socket

BS 5733:2010

Features

- Grid modules clip fit to frame without special tools
- Modules can be removed/replaced when grid frame is fixed in position
- Grid Plus frontplates available to match all MK wiring device ranges
- All products are 100% tested before delivery
- Options of neon/filament indicators label in rocker or printed rockers
- Wide variety of switch modules rated at 10 or 20 amps
- Single or double dimmer modules available
- Vast range of grid plates and modules from one source
- High quality grid frame
- Grid frame earth terminal has 16mm² cable capacity
- Backed out and captive terminal screws
- Plated grid frame prevents corrosion
- Up to 12 gang Logic Plus grid frontplates and up to 24 gang in decorative metal finish frontplates
- Top access terminal screws

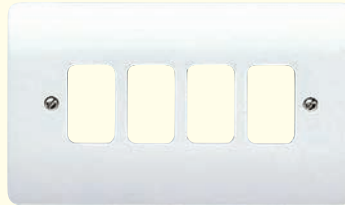

Description

Grid Plus is a comprehensive modular switching and monitoring system ideal for a variety of applications within the commercial, public and domestic sectors.

Grid Plus cover plates have the advantageous design features of the MK wiring device ranges and the interchangeable modules also feature many of the wiring and installation benefits common to the MK wiring device ranges.

The system is extremely easy to assemble (see illustration) and modules can be individually changed without re-wiring of complete assembly by removal of frontplate and simply clipping in or out as required. For further installation details see 'Installation' overleaf.

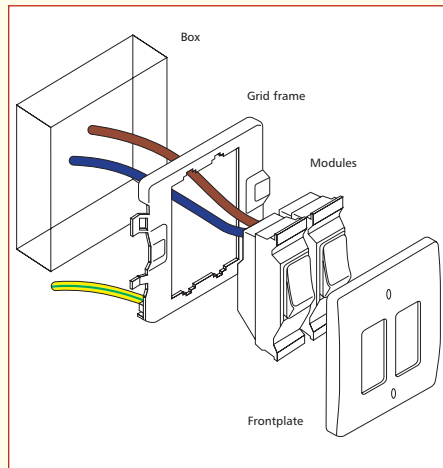

Module Dimensions (mm)

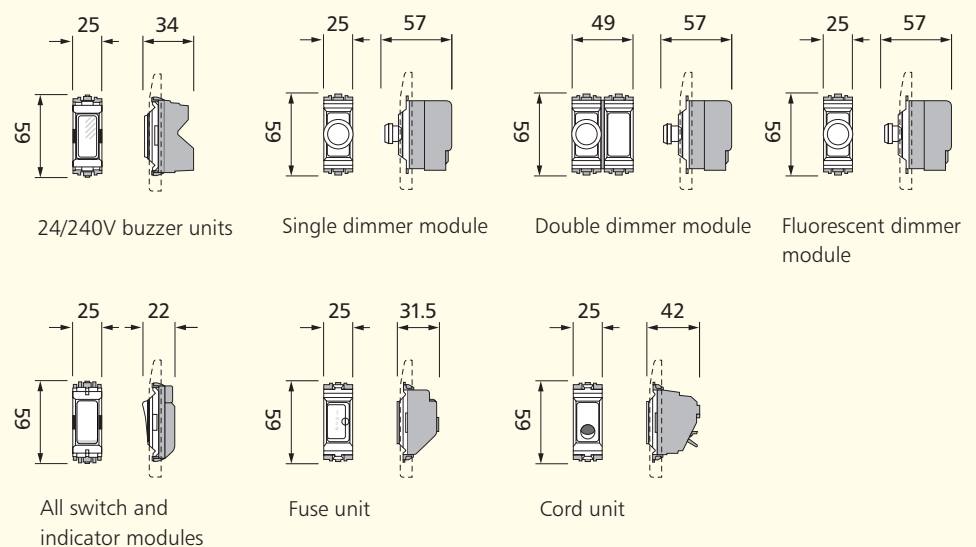

Multiple dimmer installation load ratings When installing more than one dimmer in multi-gang plates, the power rating must be reduced to allow for heat generation.

Modular Switching System

FRONTPLATE DIMENSIONS					
Range	Modules	A	B	C	D
Logic Plus	1,2,3,4,6,8,12	86	146	206	N/A
Aspect	1,2,3,4,6,8	86	146	N/A	N/A
Edge	1,2,3,4,6,8,9,12,18,24	86	146	206	267
Albany Plus	1,2,3,4,6,8,9,12,18,24	86	146	206	267
Metal Clad	1,2,3,4,6,8,9,12,18,24	86	146	206	267

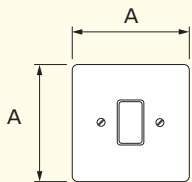
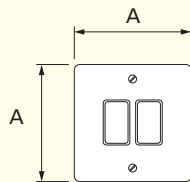
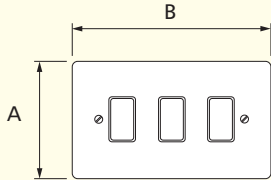
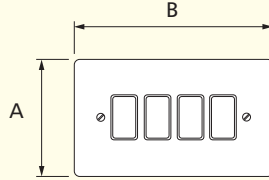
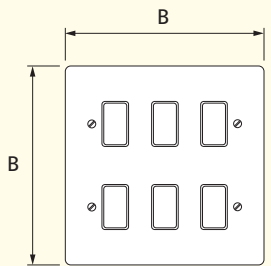
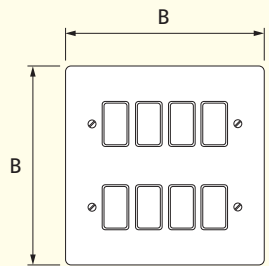
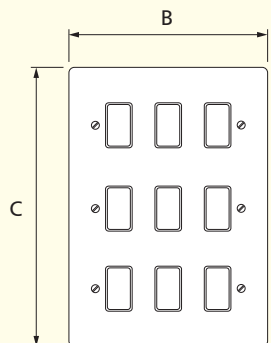
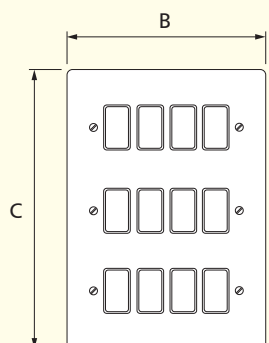
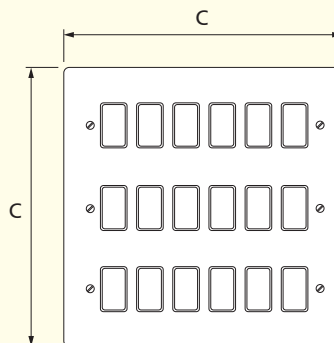
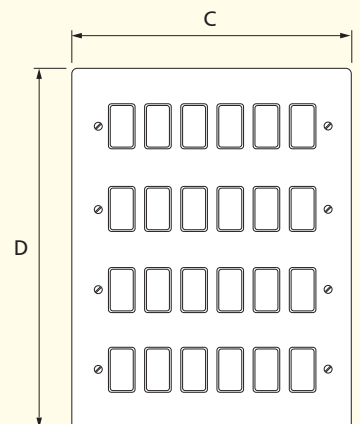
1 module

2 module

3 module

4 module

6 module

8 module

9 module

12 module

18 module

24 module

Technical specification

Electrical

Switches

Voltage rating:
250V a.c., 50 Hz

Current rating:
10 or 20 amps – no derating when used
on fluorescent or inductive loads.

Load type:
No restriction

Terminal capacity:
4 x 1mm², 4 x 1.5mm², 4 x 1mm²,
3 x 2.5mm², 2 x 4mm², 1 x 6mm²

Indicator Units

Voltage rating:
24V indicators - min. 21V, max. 36V
240V indicators - min. 200V, max 250V

Terminal capacity:
as switches

Buzzer Unit

Voltage rating:
240V
24V

Terminal capacity:
as switches

Fuse Unit

Voltage rating:
250V

Current rating:
13 amps

Terminal capacity:
2 x 4mm²

Cord Outlet

Voltage rating:
250V

Current rating:
16 amps

Terminal capacity
Supply: 2 x 4mm²
Load: 1 x 1.5mm² multi-strand

Dimmers

Voltage rating:
230V a.c., 50Hz

Load rating:
For single dimmer installations:
K4500 min. 40W/VA, max. 400W/320 VA
K4501 min. 40W/VA, max. 220W/180 VA
For multiple dimmer installation see Load
Adjustment table, page 491

Load types:
K4500, K4501 tungsten filament (GLS)
lamps
Low voltage lighting electronic or wire-
wound transformers

Soft start:
Raises from low to control knob setting in
1-3 secs, (increases lamp life significantly)

Terminal capacity
1 x 2.5mm², 2 x 1.5mm²

Universal Socket

Voltage rating
125/250V

Current rating:
16 amps

Terminal capacity
2 x 6mm² (stranded)
3 x 4mm² 3 x 2.5mm²

Modular Switching System

Standards and approvals

Switch modules

BS EN 60669-1: 1999

Indicator units

BS 5733:2010

Dimmer switches

Dimmers comply with BS EN 60669-2-1,
BS EN 55015

Accessory modules

Single non-isolated, TV/FM socket outlet,
BS 3041 Part 2: 1977

Technical specification

Physical (all products)

Operating temperature:
-5°C to +40°C

IP rating:
IP4X

Max. installation altitude:
2000 metres

Installation

General

Cut cables to length and make earth connections to grid. Earth: bond Grid Frame to metal mounting box. Grid frames are screwed to back box, modules wired as appropriate and simply clipped into grid frame by hand. No tools are necessary. The front plate is screw fixed to the grid frame to finish the assembly.

To remove or change modules, simply remove front plate. Individual modules fit perfectly into the frontplate in flush fitting installations.

Grid mounting

An integral design feature automatically ensures that the modules fit perfectly into the frontplate in flush fitting installations.

Some manual adjustment may be required for surface mounted applications.

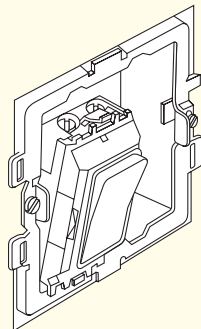

- 1 Locate bottom tab of module in base of grid.
- 2 Module pushes into place at top with a 'click'.
- 3 To remove module, press tab at top and lever forward.

Dimmers

The two module size dimmer can be fitted to any grid mounting frame over 1 gang. The supplied blank module can be placed at the required pitch to fill in the second position on the grid.

To avoid overheating when using more than one dimmer in the same Grid Plus Enclosure it is recommended that the dimmers are preferentially mounted on the bottom row on 6, 8, 9, 12, 18 and 24 Gang Enclosures, before mounting on any other rows and its load adjusted in accordance with the information provided in the Load Adjustment Table 1 at the bottom of the next page.

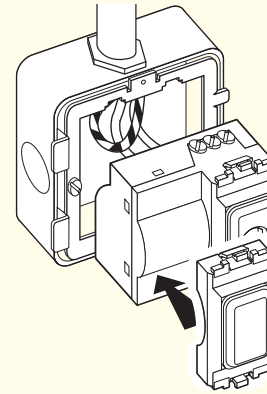

Typical mounting arrangement

Dimmer wiring diagram

One-way switching

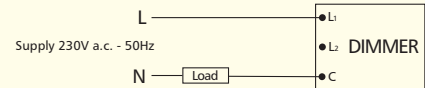

Two-way switching (only one dimmer can be used)

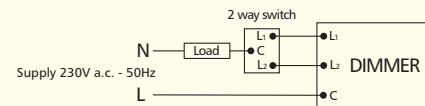

Wires must be connected to the correct Dimmer terminals. Supply Earth must only be connected to the installation metalwork and not to any of the terminals on the dimmer module.

Rocker window labels

The following labels are available for insertion into window rockers.

air conditioner	water heater	dish washer	store
bedroom	dining area	kitchen	lounge
pool	lights	bar	conference room
office	reception	bell	push
front	middle	bottom	rear
back	top	landing	hall
porch	toilets	ladies	gents
exterior			

The simple installation process is shown on the right.

Spare labels and windows are available.

TV/FM socket outlets

The TV outlet must not be mounted in the same enclosure as mains exceeding 50V.

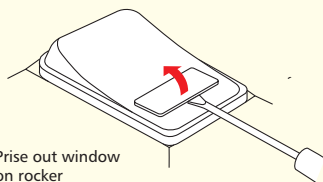

Prise out window on rocker

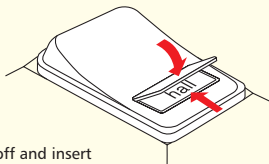

Peel off and insert label. Replace window

TABLE 1 – LOAD ADJUSTMENT FOR GRID PLUS DIMMERS

Frontplate Size, Number of Gangs	2	3	4	6	8	9	12	18	24
Max Power/Load per Row – Tungsten GLS Lamps – W	400	480	480	480	480	480	480	720	720
Max Power/Load per Row – Mains Tungsten Halogen Lamps or Low Voltage Transformers – W or VA	320	380	380	380	380	380	380	580	580
Max Power/Load for Total Plate – Tungsten GLS Lamps – W	400	480	480	740	740	940	940	1440	1800
Max Power/Load for Total Plate – Mains Tungsten Halogen Lamps or Low Voltage Transformers – W or VA	320	380	380	600	600	750	750	1155	1440

To ensure good thermal management and to ensure reliability:

In multi row Grid Plus installations, mount dimmers in the lower rows wherever possible. Do not mount dimmers in adjacent locations; try to separate them as much as possible.

Printed Modules

A wide range of pre-printed switches are also available. See pages 175-193 for details.

Grid Plus Dimmer Switches

Standards and approvals

All Grid Plus dimmer switches comply with the EC Low Voltage Directive: 73/23/EEC, Electromagnetic Compatibility Directive 89/336/EEC.

They also comply with BS EN 60669-2-1 and IEC 60669-2-1 (LED Intelligent Dimmer only).

Technical specification

Electrical

Mains Supply Voltage:
230V a.c. (Nominal)
220V a.c. to 240V a.c. (For LED Intelligent Dimmer)

Mains Supply Voltage Range:
216V a.c. to 253V a.c.
198V a.c. to 264V a.c. (For LED Intelligent Dimmer)

Mains Supply Frequency:
50Hz \pm 3Hz

Type of Loads:

Intelligent Dimmers and LED Intelligent Dimmers: Fused GLS Tungsten Filament lamps to BS EN 60064: 1996 and BS EN 60432-1,2 rated at 230/240V. Dimmable wire wound or electronic Low Voltage Transformers of good quality. Can also be used with good quality mains voltage halogen lamps incorporating GU10 bases. Please check with lamp manufacturer to determine suitability.

In addition, LED Intelligent dimmers are suitable for dimmable LED bulbs rated at 220-240V for incandescent replacement.

Note: Transformer must be suitable for dimming using phase delay (not phase cut) type of dimmers.

Warning: These dimmer switches are not suitable for use with Fluorescent Lamps or Energy Saving Lamps.

Physical

Operating temperature:
0°C to +40°C

IP rating:
IP4X

Max. installation altitude:
2000 metres



Description

Intelligent Dimmers and LED Intelligent Dimmers

Dimmer Switches belonging to this category employ the latest, state of the art, micro-controller base electronic circuitry and use current sensing to compute the load conditions. These products show progressive reaction to Over-load conditions, depending on the extent of Over-load – see Table 1. List numbers belonging to this category are identified by the suffix letters LV, e.g. K4501 WHI LV. These Dimmer Switches employ one pole change over switches to facilitate two way switching.

MK Grid Plus Dimmer Switches are not suitable for use with Fluorescent Loads, including Energy Saving Lamps.

Features

MK Grid Plus Dimmer Switches incorporate the following advanced features

- Suitable for dimming Low Voltage Halogen lamps via suitable, fully dimmable electronic or wire-wound transformers. See Table 2 for the number of transformers allowed to be used with each dimmer
- Can be used with good quality mains voltage halogen lamps incorporating GU10 bases. Please check with lamp manufacturer to determine suitability
- Unidirectional current sensing. While being used with wire-wound transformers for low voltage lighting, these dimmer switches continuously monitor the drive conditions to the transformers, which require essentially, bi-directional a.c. supply at their input terminals. If, due to some fault condition, the supply to the wire-wound transformer is detected to be unidirectional, which could result in over-heating and/or damaging the transformer, the dimmer switches' circuitry automatically stops supplying the transformer after a few cycles of detected unidirectional supply
- Soft Start, which gradually increases the light output from the load over 1 to 3 seconds after switch on. The Soft Start feature is also particularly beneficial when used to dim Mains Voltage Tungsten Halogen lamps which have inherent very high inrush current at switch on
- In addition, LED Intelligent dimmers are suitable for dimmable LED bulbs rated at 220-240V for incandescent replacement.

Cable Management

Grid Plus dimmer switches can be mounted in a variety of MK trunking systems.

Grid Plus Dimmer Switches

TABLE 1 – OVERLOAD REACTION		
40-400W CIRCUIT	40-300W CIRCUIT	LED INTELLIGENT DIMMER
Overload management: 40-400W nominal 40-500W function without dimming > 500-700W dim to minimum level > 700W switch off	Overload management: 40-220W nominal 40-275W function without dimming > 275-375W dim to minimum level > 375W switch off	Overload management: 40-220W nominal 40-275W function without dimming > 275-440W dim to minimum level > 440W switch off

Dimensions

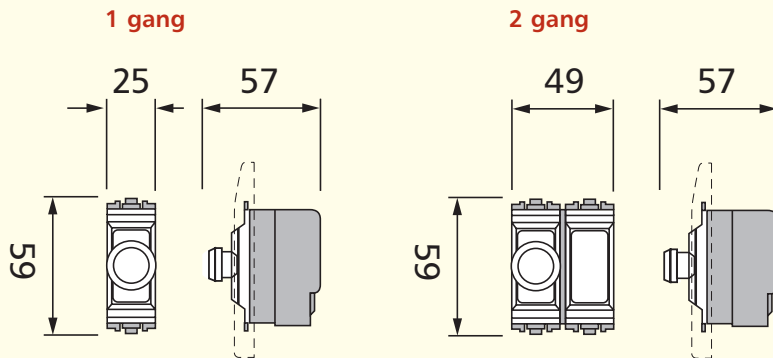

TABLE 2 – GRID PLUS INTELLIGENT DIMMER SWITCHES		
	Rating	Max No. of Transformers
1 module dimmer switch	40-220W (LV rating 40-180VA)	3
2 module dimmer switch	40-400W (LV rating 40-320VA)	5

TABLE 3 – GRID PLUS LED INTELLIGENT DIMMER SWITCHES					
	Rating			Max No. of Transformers and LEDs (total rating must not exceed MAX. VA rating of dimmer)	
	GLS and mains voltage halogen	Electronic or wire wound LV transformers	LED	Transformers	LEDs
1 gang single dimmer	40-220W	40-180W/VA	4-70W	3	10

Do not connect more than the maximum number of transformers stated for each dimmer. Grid Plus dimmer switch ratings are for each dimmer when installed singly.

In multiple installations, each dimmer switch must be de-rated – see Table 1 under 'Modular Switching System' section.

Fluorescent Dimmer

MK Fluorescent dimmers are low voltage controllers that require only a single two-core wire connection to 1-10V controllable ballast inputs. The dimmer operates by applying a variable resistance to the ballast 1-10V control input.

We recommend using a separate on/off switch to isolate the luminaire(s) in use.

Features

Preset adjust to set minimum light level. Preset adjust for use with multiple dimmable ballasts.

Up to four ballasts can be connected to one dimmer.

Wiring Diagrams

One-way switching

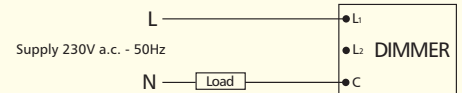

Two-way switching

(only one dimmer can be used)

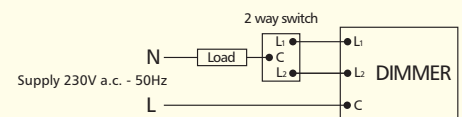

Wires must be connected to the correct dimmer terminals. DO NOT connect earth to dimmer.

Fluorescent dimmer

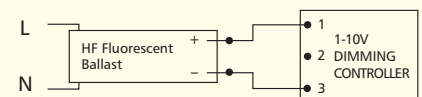

Wires must be connected to the correct dimmer terminals. DO NOT connect earth to dimmer.

Minimum Brightness Adjustment for LED Intelligent Dimmers

The light output of some LED lamps may appear to be too dim or invisible when the dimmer knob is at the minimum dim level. Follow the steps below to adjust the minimum brightness level. This feature is primarily for adjusting the minimum brightness level of the LED lamp although it can be used for other load types. For a double gang dimmer, the light level of each gang has to be adjusted separately.

Step 1 Access To Programming Mode

1. Push the dimmer knob so that it is in OFF state.
2. Set the dimmer knob to minimum level.

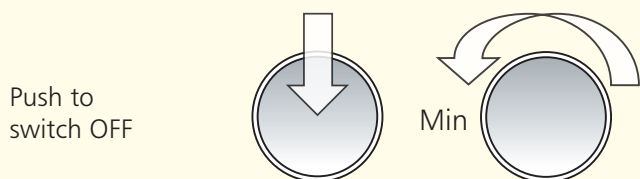

3. Turn on the dimmer and immediately rotate the knob 3 times in full rotary span within 5 seconds.

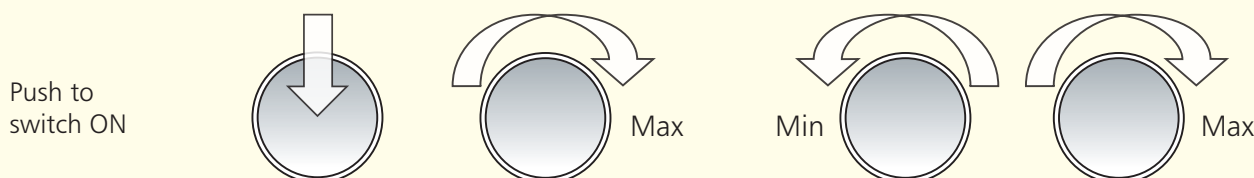

NOTE: - Wait for 3 seconds, the lamp will then dim to minimum before automatically brightening to about 30% level.

Turning/pushing the dimmer knob before the end of automatic brightening will end access to programming mode

4. Dimmer enters programming mode.

Step 2 Adjust Brightness Level and Exit Programming Mode

5. Rotate the dimmer knob anticlockwise to adjust the lamp to the desired brightness level.

NOTE: - Some LED lamps may not work properly if the brightness level is set too low thus it is recommended to keep the brightness level of the lamp at a visible level. The dimmer will exit programming mode automatically without saving the new setting if there is no dimmer knob movement for 15 seconds. The dimmer will restore its factory default light level.

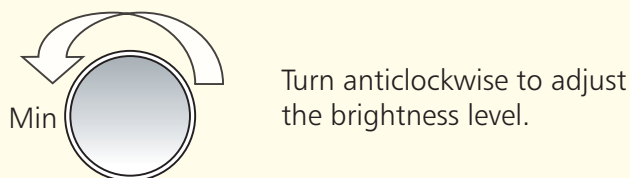

6. Confirm the new setting and exit programming mode by turning OFF the dimmer.

Push to switch OFF

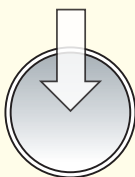

Step 3 Success indication (Programming Complete)

7. The next time the dimmer is turned on the lamp will automatically brighten to the maximum level before dimming to the brightness level corresponds to the knob level.

SPARE PAGE?