

DECOSTAR 51 ECO 20 W 12 V 36° GU5.3

DECOSTAR 51 ECO | Halogen dichroic reflector lamps with 51 mm diameter



Areas of application

- General illumination
- Kitchen lighting
- Dining table lighting
- Mirror lighting
- Workplace lighting
- Shops
- Restaurants, hotels and similar prestigious applications

Product benefits

- Brilliant ECO accent lighting
- Significantly lower CO₂ emissions
- Constant luminous intensity and constant color location throughout
- Approved for use in open luminaires (to IEC 60598-1)
- UV filter
- Contains no mercury

Product features

- Average life: 5,000 h
- Dimmable
- Color rendering index R_a: 100
- Color temperature: 3,000 K



Product datasheet

Technical data

Electrical data

Nominal wattage	20.00 W
Nominal voltage	12 V
Rated wattage	20.00 W
Claimed equiv. conventional lamp power	35 W
Power factor λ	1.00
Energy consumption	22 kWh/1000h

Photometrical data

Nominal useful luminous flux 90°	300 lm
Luminous intensity	1000 cd
Color temperature	3000 K
Light color as per EN 12464-1	Warm White
Color rendering index Ra	100
Lumen main.fact.at end of nom.life time	0.75
Rated useful luminous flux 90°	300 lm

Light technical data

Beam angle	36 °
Starting time	0.0 s
Warm-up time (60 %)	0.00 s

Dimensions & weight

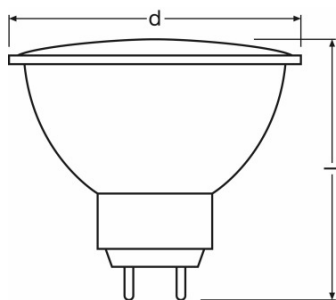

Product line drawing

Diameter	51.0 mm
----------	---------

Product datasheet

Length	46.0 mm
Overall length	45.0 mm
Outer bulb	MR51
Maximum diameter	51.0 mm

Colors & materials

Lamp mercury content	0.0 mg
Mercury-free	Yes

Lifespan

Nominal lamp life time	5000 h
Rated lamp life time	5000 h
Number of switching cycles	125000 ¹⁾

¹⁾ At 1 min on / 3 min off

Additional product data

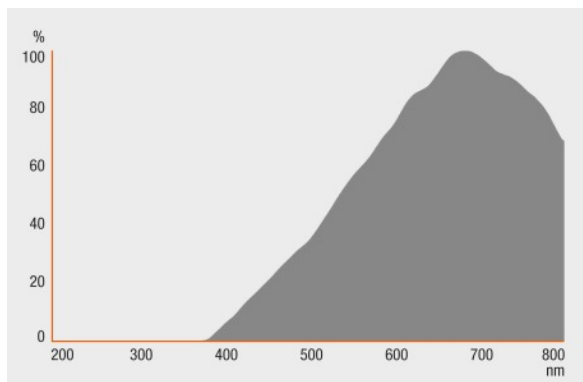

Spectral power distribution

Base (standard designation)	GU5.3
------------------------------------	-------

Capabilities

Burning position	Any
Dimmable	Yes

Product datasheet

Certificates & standards

Energy efficiency class	B
-------------------------	---

Country specific categorizations

ILCOS	HRGS//UBIB-20-12-GU5.3-51/36
Order reference	48860 ECOWFL 20

Country specific information

Product code	METEL code	SEG number	STK number	UK Org
4050300620206	OSRH48860WFLECO	8326914	4735324	-

Product datasheet

Logistical Data

Product code	Product description	Packaging unit (Pieces/Unit)	Dimensions (height x width x length)	Volume	Gross weight
4050300620206	DECOSTAR 51 ECO 20 W 12 V 36° GU5.3	Folding carton box 1	46 mm x 46 mm x 58 mm	0.12 dm ³	38.00 g
4050300956893	DECOSTAR 51 ECO 20 W 12 V 36° GU5.3	Shipping carton box 20	106 mm x 119 mm x 238 mm	3.00 dm ³	836.00 g

The mentioned product code describes the smallest quantity unit which can be ordered. One shipping unit can contain one or more single products. When placing an order, for the quantity please enter single or multiples of a shipping unit.

References / Links

For light distribution curves see

▶ www.osram.com

Disclaimer

Subject to change without notice. Errors and omission excepted. Always make sure to use the most recent release.