

# AVIVO BATTERY

## Specification

Nominal Voltage	2V	
Nominal Capacity(10HR)	300.0AH	
Dimensions	Length	170±2mm (6.69 inches)
	Width	150±2mm (5.91 inches)
	Container Height	328±3mm (12.91 inches)
	Total Height (with Terminal)	350±3mm (13.78 inches)
Approx Weight	Approx 18.0 kg	
Terminal	T4	
Container Material	ABS	
Rated Capacity	321.0 AH/16.05A	(20hr , 1.80V/cell,25°C/77°F)
	300.0 AH/30.0A	(10hr, 1.80V/cell,25°C/77°F)
	240.0 AH/48.0A	(5hr, 1.75V/cell,25°C/77°F)
	225.0 AH/75.0A	(3hr, 1.75V/cell,25°C/77°F)
	183.0AH/183.0A	(1hr, 1.60V/cell,25°C/77°F)
Max. Discharge Current	2400A (5s)	
Internal Resistance	Approx 0.9mΩ	
Operating Temp.Range	Discharge	-15~50°C (5~122°F)
	Charge	0~40°C (32~104°F)
	Storage	-15~40°C (5~104°F)
Nominal Operating Temp. Range	25±3°C (77±5°F)	
Cycle Use	Initial Charging Current less than 90.0A.Voltage	
	2.4V~2.5V at 25°C(77°F)Temp. Coefficient -5mV/°C	
Standby Use	No limit on Initial Charging Current Voltage	
	2.25V~2.3V at 25°C(77°F)Temp. Coefficient -3mV/°C	
Capacity affected by Temperature	40°C (104°F)	103%
	25°C (77°F)	100%
	0°C (32°F)	86%
Self Discharge	Pattern PT series battery may be stored for up to 6 months at 25°C(77°F) and then a freshening charge is required. For higher temperatures the time interval will be shorter.	

## GFM-300



## Applications

- ◆ Tele-communication central station (wired or cellular)
- ◆ Power system communication, military communication, etc.
- ◆ Network communication including: data transmission, television signal transmission, etc.
- ◆ Uninterruptable Power System (UPS- for Telecom)

Intertek



## Constant Current Discharge (Amperes) at 25 °C (77°F)

15min	20min	30min	45min	1h	2h	3h	4h	5h	6h	8h	10h	20h	V/cell
330.00	285.00	228.00	174.00	141.00	90.00	69.00	57.00	45.00	39.00	33.00	28.50	15.41	1.85
420.00	339.00	267.00	189.00	159.00	96.00	72.00	60.00	46.50	42.00	34.50	30.00	16.05	1.80
450.00	366.00	279.00	201.00	165.00	99.00	75.00	63.00	48.00	43.50	36.00	30.90	16.69	1.75
480.00	384.00	291.00	213.00	171.00	102.00	78.00	65.40	51.00	45.00	37.50	32.10	17.33	1.70
510.00	405.00	300.00	222.00	177.00	108.00	81.00	67.50	54.00	46.50	39.00	33.30	17.98	1.65
540.00	420.00	315.00	231.00	183.00	114.00	84.00	70.50	57.00	49.50	42.00	34.50	18.62	1.60

## Constant Power Discharge (Watts) at 25 °C (77°F)

15min	20min	30min	45min	1h	2h	3h	4h	5h	6h	8h	10h	20h	V/cell
610.50	527.25	421.80	321.90	260.85	166.50	127.65	105.45	83.25	72.15	61.05	52.73	28.50	1.85
756.00	610.20	480.60	340.20	286.20	172.80	129.60	108.00	83.70	75.60	62.10	54.00	28.89	1.80
787.50	640.50	488.25	351.75	288.75	173.25	131.25	110.25	84.00	76.13	63.00	54.08	29.21	1.75
816.00	652.80	494.70	362.10	290.70	173.40	132.60	111.18	86.70	76.50	63.75	54.57	29.47	1.70
841.50	668.25	495.00	366.30	292.05	178.20	133.65	111.38	89.10	76.73	64.35	54.95	29.66	1.65
864.00	672.00	504.00	369.60	292.80	182.40	134.40	112.80	91.20	79.20	67.20	55.20	29.79	1.60

# Dimensions

## T4 Terminal

Unit: mm

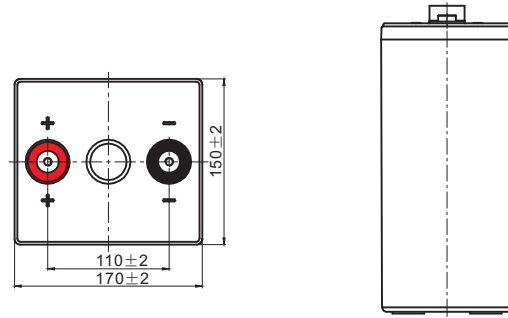
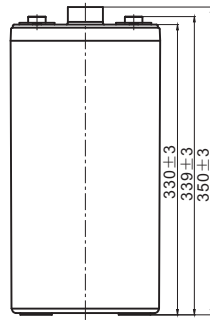
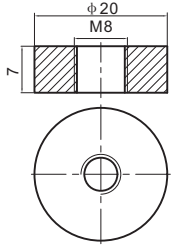

## Discharge Characteristics

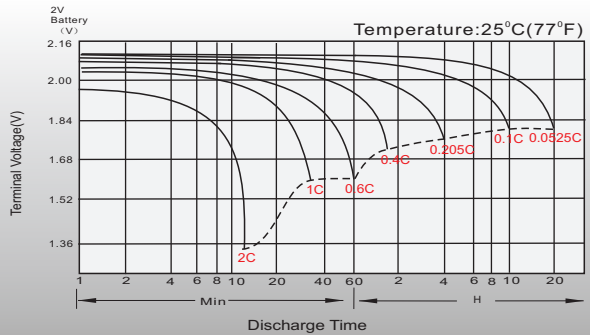

## Float Charging Characteristics

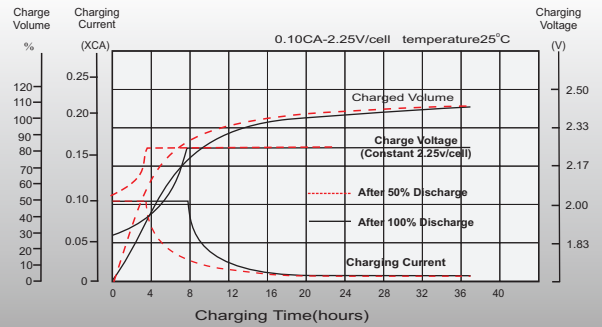

## Temperature Effects in Relation to Battery Capacity

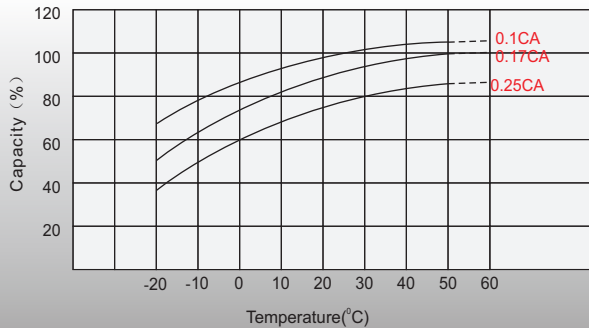

## Effect of Temperature on Long Term Float Life

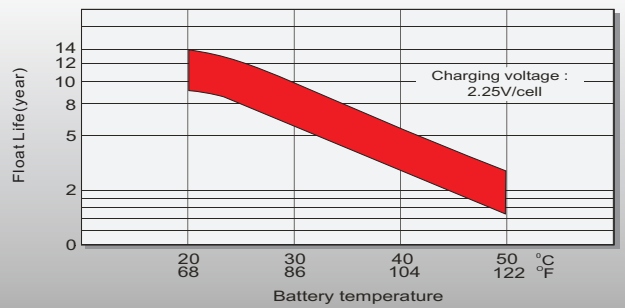

## Cycle Life in Relation to Depth of Discharge

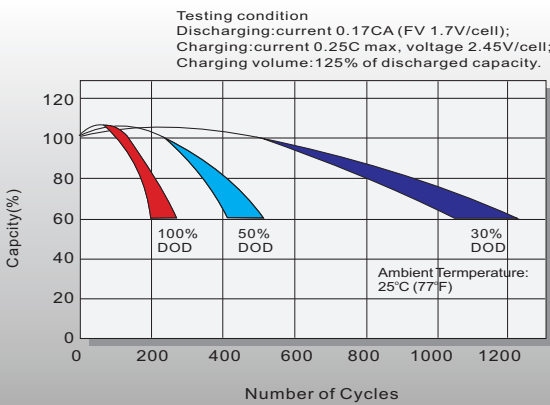

## Self Discharge Characteristics

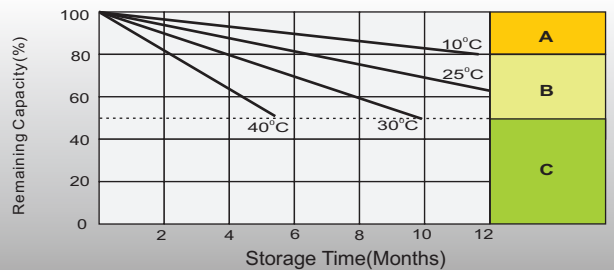

- A** No supplementary charge required  
(Carry out supplementary charge before use if 100% capacity is required.)
- B** Supplementary charge required before use. Optional charging way as below:  
1. Charged for above 3 days at limited current 0.25CA and constant voltage 2.25V/cell.  
2. Charged for above 20 hours at limited current 0.25CA and constant voltage 2.45V/cell.  
3. Charged for 8-10 hours at limited current 0.05CA.
- C** Supplementary charge may often fail to recover the capacity.  
The battery should never be left standing till this is reached.