



**it's cool to be safe**  
*explosion proof solution for the global market*



CGA  
CG - CGF  
CGI - CGL - CGV  
CGP  
PLP - LNP  
CGAW  
CGW  
CGPW  
PLH - PLR  
RAA - RAB - RAM - RAN  
BFF - RFF  
BMF - RMF  
BMM - RMM  
EYS - EZS  
SND - SBD  
FG - ET - LN - SH - SHA

**it's cool to be safe**  
explosion proof electrical equipment



## SUPER CONNECT

The equipment we introduce in this catalogue are designed to satisfy most of our clients' requirements to CONNECT explosion proof electrical equipment.

All equipment are manufactured using materials able to resist in most highly corrosive environment and to ensure a modern functionality solution and a long duration of investment.



## RAM series

female - female couplings & adaptors

The RAM couplings are used to convert a male hub into an equivalent or reduced or increased female hub.

The RAM fittings with same diameter size and thread type on both side are used to connect conduits with threaded ends.

The adaptors (reducers / enlargers) are used to provide means of connection between same or dissimilar thread forms (e.g. NPT to Metric).

## Couplings RAM

RAM		FEMALE thread - NPT ANSI ASME B1.20.1										
		1/4"	3/8"	1/2"	3/4"	1"	1" 1/4	1" 1/2	2"	2" 1/2	3"	4"
FEMALE thread - NPT ANSI ASME B1.20.1	1/4"	02N02N										
	3/8"	01N02N	01N01N									
	1/2"	1N02N	1N01N	1N1N								
	3/4"	2N02N	2N01N	2N1N	2N1N							
	1"	3N02N	3N01N	3N1N	3N2N	3N3N						
	1" 1/4	4N02N	4N01N	4N1N	4N2N	4N3N	4N4N					
	1" 1/2	5N02N	5N01N	5N1N	5N2N	5N3N	5N4N	5N5N				
	2"	6N02N	6N01N	6N1N	6N2N	6N3N	6N4N	6N5N	6N6N			
	2" 1/2	7N02N	7N01N	7N1N	7N2N	7N3N	7N4N	7N5N	7N6N	7N7N		
	3"	8N02N	8N01N	8N1N	8N2N	8N3N	8N4N	8N5N	8N6N	8N7N	8N8N	
	4"	10N02N	10N01N	10N1N	10N2N	10N3N	10N4N	10N5N	10N6N	10N7N	10N8N	10N10N

RAM		FEMALE thread - Metric Pitch 1.5 - ISO 262										
		12	16	20	25	32	40	50	63	75	90	110
FEMALE thread - Metric Pitch 1.5 - ISO 262	12	02M02M										
	16	01M02M	01M01M									
	20	1M02M	1M01M	1M1M								
	25	2M02M	2M01M	2M1M	2M2M							
	32	3M02M	3M01M	3M1M	3M2M	3M3M						
	40	4M02M	4M01M	4M1M	4M2M	4M3M	4M4M					
	50	5M02M	5M01M	5M1M	5M2M	5M3M	5M4M	5M5M				
	63	6M02M	6M01M	6M1M	6M2M	6M3M	6M4M	6M5M	6M6M			
	75	7M02M	7M01M	7M1M	7M2M	7M3M	7M4M	7M5M	7M6M	7M7M		
	90	8M02M	8M01M	8M1M	8M2M	8M3M	8M4M	8M5M	8M6M	8M7M	8M8M	
	110	10M02M	10M01M	10M1M	10M2M	10M3M	10M4M	10M5M	10M6M	10M7M	10M8M	10M10M

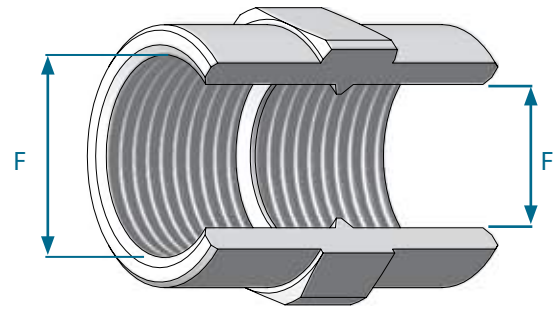

## Adaptors RAM

RAM		FEMALE thread - Metric Pitch 1.5 - ISO 262										
		12	16	20	25	32	40	50	63	75	90	110
FEMALE thread - NPT ANSI ASME B1.20.1	1/4"	02N02M										
	3/8"	01N02M	01N01M									
	1/2"	1N02M	1N01M	1N01M								
	3/4"	2N02M	2N01M	2N1M	2N2M							
	1"	3N02M	3N01M	3N1M	3N2M	3N3M						
	1 1/4"	4N02M	4N01M	4N1M	4N2M	4N3M	4N4M					
	1 1/2"	5N02M	5N01M	5N1M	5N2M	5N3M	5N4M	5N5M				
	2"	6N02M	6N01M	6N1M	6N2M	6N3M	6N4M	6N5M	6N6M			
	2 1/2"	7N02M	7N01M	7N1M	7N2M	7N3M	7N4M	7N5M	7N6M	7N7M		
	3"	8N02M	8N01M	8N1M	8N2M	8N3M	8N4M	8N5M	8N6M	8N7M	8N8M	
4"	10N02M	10N01M	10N1M	10N2M	10N3M	10N4M	10N5M	10N6M	10N7M	10N8M	10N10M	

RAM		FEMALE thread - NPT ANSI ASME B1.20.1										
		1/4"	3/8"	1/2"	3/4"	1"	1 1/4"	1 1/2"	2"	2 1/2"	3"	4"
FEMALE thread - Metric Pitch 1.5 - ISO 262	12	02M02N										
	16	01M02N	01M01N									
	20	1M02N	1M01N	1M1N								
	25	2M02N	2M01N	2M1N	2M2N							
	32	3M02N	3M01N	3M1N	3M2N	3M3N						
	40	4M02N	4M01N	4M1N	4M2N	4M3N	4M4N					
	50	5M02N	5M01N	5M1N	5M2N	5M3N	5M4N	5M5N				
	63	6M02N	6M01N	6M1N	6M2N	6M3N	6M4N	6M5N	6M6N			
	75	7M02N	7M01N	7M1N	7M2N	7M3N	7M4N	7M5N	7M6N	7M7N		
	90	8M02N	8M01N	8M1N	8M2N	8M3N	8M4N	8M5N	8M6N	8M7N	8M8N	
110	10M02N	10M01N	10M1N	10M2N	10M3N	10M4N	10M5N	10M6N	10M7N	10M8N	10M10N	



## Ordering Tables

Thread Type	N	M	P	BP	BT	G
02	1/4"	12	-	1/4"	1/4"	1/4"
01	3/8"	16	-	3/8"	3/8"	3/8"
1	1/2"	20	7	1/2"	1/2"	1/2"
2	3/4"	25	9	3/4"	3/4"	3/4"
Thread Size	3	1"	32	11	1"	1"
	4	1"1/4	40	13,5	1"1/4	1"1/4
	5	1"1/2	50	16	1"1/2	1"1/2
	6	2"	63	21	2"	2"
	7	2"1/2	75	29	2"1/2	2"1/2
	8	3"	90	36	3"	3"
	9	-	-	42	-	-
10	4"	110	48	4"	4"	

Thread Type	Code	Description
	N	NPT - ANSI ASME B1.20.1
	M	Metric Pitch 1.5 - ISO 262
	P	PG - DIN 40430
	BP	BSPP - ISO 228/1
	BT	BSPT - ISO 228/1
	G	GAS ISO 7/1

Material	Code	Description
	B	Brass
	N	Nickel-Plated Brass
	P	Polyamide
	G	Galvanized Steel
	S	Stainless Steel





# Ordering Codes

How to order ..... :

## CABLE GLANDS :

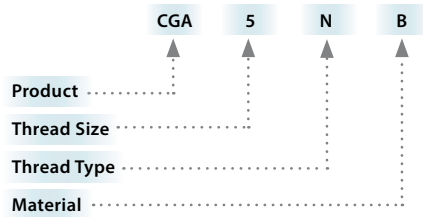

Example above code:

- Product: Cable Gland for Armoured Cable
- Thread Size and Type: 1" 1/2 NPT
- Material: Brass

## PLUGS :

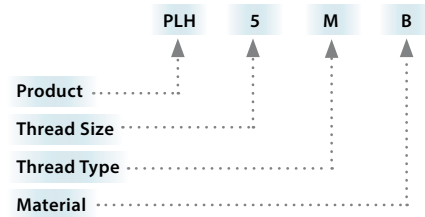

Example above code:

- Product: Plugs with external hexagon
- Thread Size and Type: M50 x 1.5
- Material: Brass

## ADAPTORS / REDUCERS :

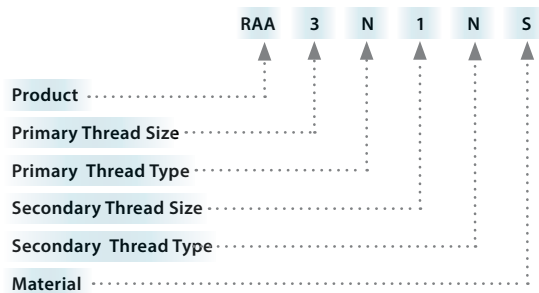

Example above code:

- Product: Adaptor (reducer) MALE - FEMALE
- MALE Thread Size and Type: 1" NPT
- FEMALE Thread Size and Type: 1/2" NPT
- Material: Stainless Steel

## ACCESSORIES :

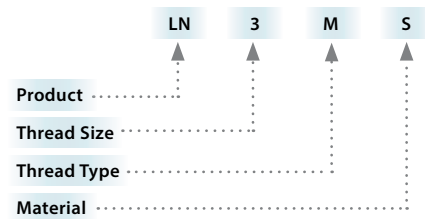

Example above code:

- Product: Locknut
- Thread Size and Type: M32 x 1.5
- Material: Stainless Steel

## THREE-PIECES UNIONS :

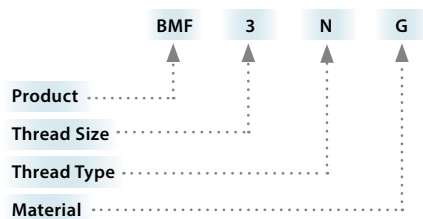

Example above code:

- Product: Male - female three pieces union
- Thread Size and Type: 1" NPT
- Material: Galvanized steel

## SEALED NIPPLES :

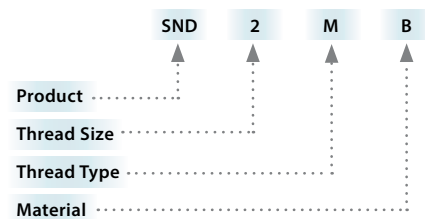

Example above code:

- Product: Sealed Nipple
- Thread Size and Type: M25 x 1.5
- Material: Brass



## INDEX

Code	Descriptions	Page
<b>Ex d - Ex e Metal Cable Glands</b>		
CGA	cable glands for armoured cables	06
CG	cable glands for unarmoured cables	07
CGF	cable glands for unarmoured cables - conduit protected	08
CGI	cable glands for unarmoured cables - conduit protected	09
CGL	cable glands for unarmoured cables - conduit protected	10
CGV	cable glands for unarmoured cables - conduit protected	11
<b>Ex e - Ex i Polyamide Cable Glands</b>		
CGP	cable glands for unarmoured cables	15
PLP	male plugs - external hexagon	16
LNP	locknuts	16
<b>Industrial Cable Glands</b>		
CGAW	metal cable glands for armoured cables	19
CGW	metal cable glands for unarmoured cables	20
CGPW	polyamide cable glands for unarmoured cables	21
<b>Ex d - Ex e Adaptors &amp; Plugs</b>		
PLH	male plugs - external hexagon	25
PLR	male plugs - recessed hexagon	26
RAA	RAA - male-female reducers & adaptors	27
RAB	male-female enlargers & adaptors	29
RAM	female-female couplings & adaptors	31
RAN	male-male nipples & adaptors	33
<b>Ex d three-piece unions</b>		
BMF - RMF	female-female three-piece unions	39
BFF - RFF	male-female three-piece unions	40
BMM - RMM	male-male three-piece unions	41
<b>Sealing fittings</b>		
DY62/N363	sealing compound	44
EYS	vertical sealing fittings	45
EZS	horizontal - vertical sealing fittings	46
<b>Ex d - Ex e Sealed nipple / bushing</b>		
SND	sealed nipples	47
SBD	sealed bushings	48
<b>Accessories</b>		
FG	gaskets	49
ET	earth tags	49
LN	locknuts	49
SH - SHA	PVC shrouds	49