

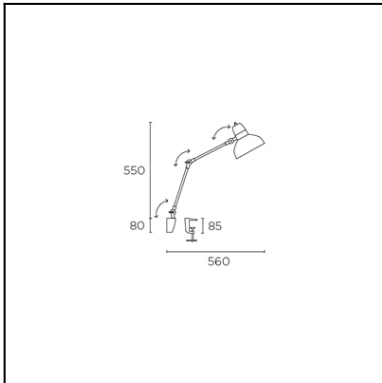

The photograph may not match the reference exactly. Please read the product description to identify the finish.



### TECHNICAL CHARACTERISTICS

Type:	Wall fixture
Adjustable:	Adjustable $\pm 180^\circ$ on the vertical axis Adjustable $\pm 90^\circ$ on the horizontal axis.
Light source 1:	1 x E27 60W Maximum lamp length: 130.00 mm Maximum lamp diameter: 70.00 mm
Voltage / Frequency:	220-240V/50-60Hz
Warranty (Years):	2
Units per box:	1
Net Weight (Kg):	1.26
EAN:	8435381402976



### MATERIALS / FINISHES

<b>Structure material:</b>	Steel
<b>Structure finish:</b>	Black Chrome

[Download photometric file .ldt / .ies](#)

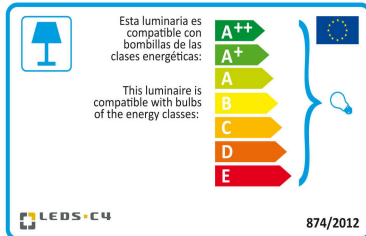

[Click on image to download energy label](#)

<b>Luminaire</b>		<b>Measur.</b>		<b>Lamp</b>		
Code	05-1531	Code	05-1531	Code	INCANDESCENT	
Name	DESK LAMP	Name	DESK LAMP	Number	1	
Line	Eulumdat	Date	16-11-2013	Position		
Efficiency	64.77%	Coordinate system	CG	Total Flux	710.00 lm	
Maximum value	170.12 cd	Position	C=270.00 G=2.00	Asymmetrical		
Rectangular Luminaire	Length	180 mm	Width	180 mm	Height	1 mm
Rectangular Luminous Area	Length	180 mm	Width	180 mm	Height	0 mm
Horizontal Luminous Area	0.032400 m2	Emitting area on Plane 180°		0.000000 m2		
Emitting area on Plane 0°	0.000000 m2	Emitting area on Plane 270°		0.000000 m2		
Emitting area on Plane 90°	0.000000 m2	Glare area at 76°		0.007838 m2		
Symmetry Type	Asymmetrical	Maximum Gamma Angle		90		
Measurement Distance	0.00	Measurement Flux		710.00 lm		
Operator		Source voltage				
Temperature	25.00 °C	Source current				
Humidity	60.00 %	Photocell				
Notes						

Luminaire Lamps						
Line	Code	Name	Flux [lm]	Pow. [W]	Q.ty	
Eulumdat	INCANDESCENT	INCANDESCENT - 57.40 W	710.00	57.40	1	
C.I.E.	48 83 97 100 65	D DIN 5040		A30		
F UTE	0.65 E	B NBN		BZ 4		

180mm x 180mm

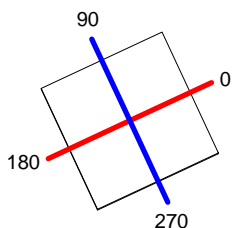

**C Halfplanes**

180.0 — 0.0

270.0 — 90.0

ULOR 0.00 %

DLOR 64.77 %

RN 0.00 %

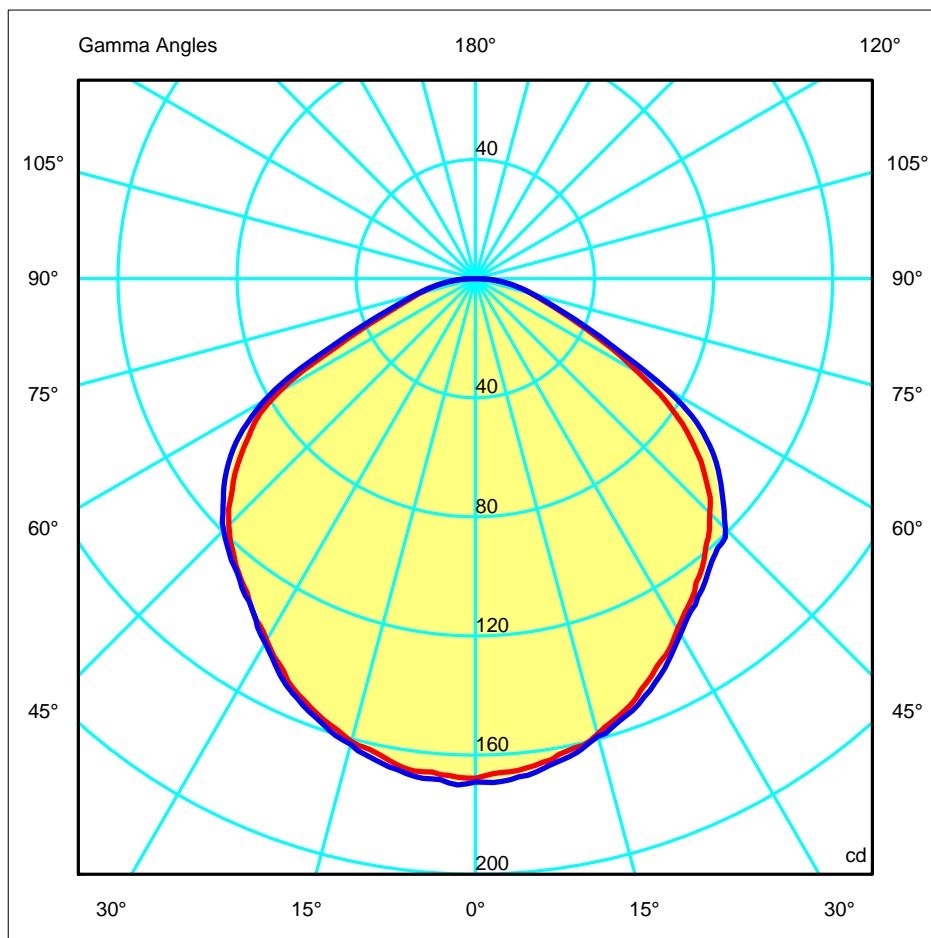

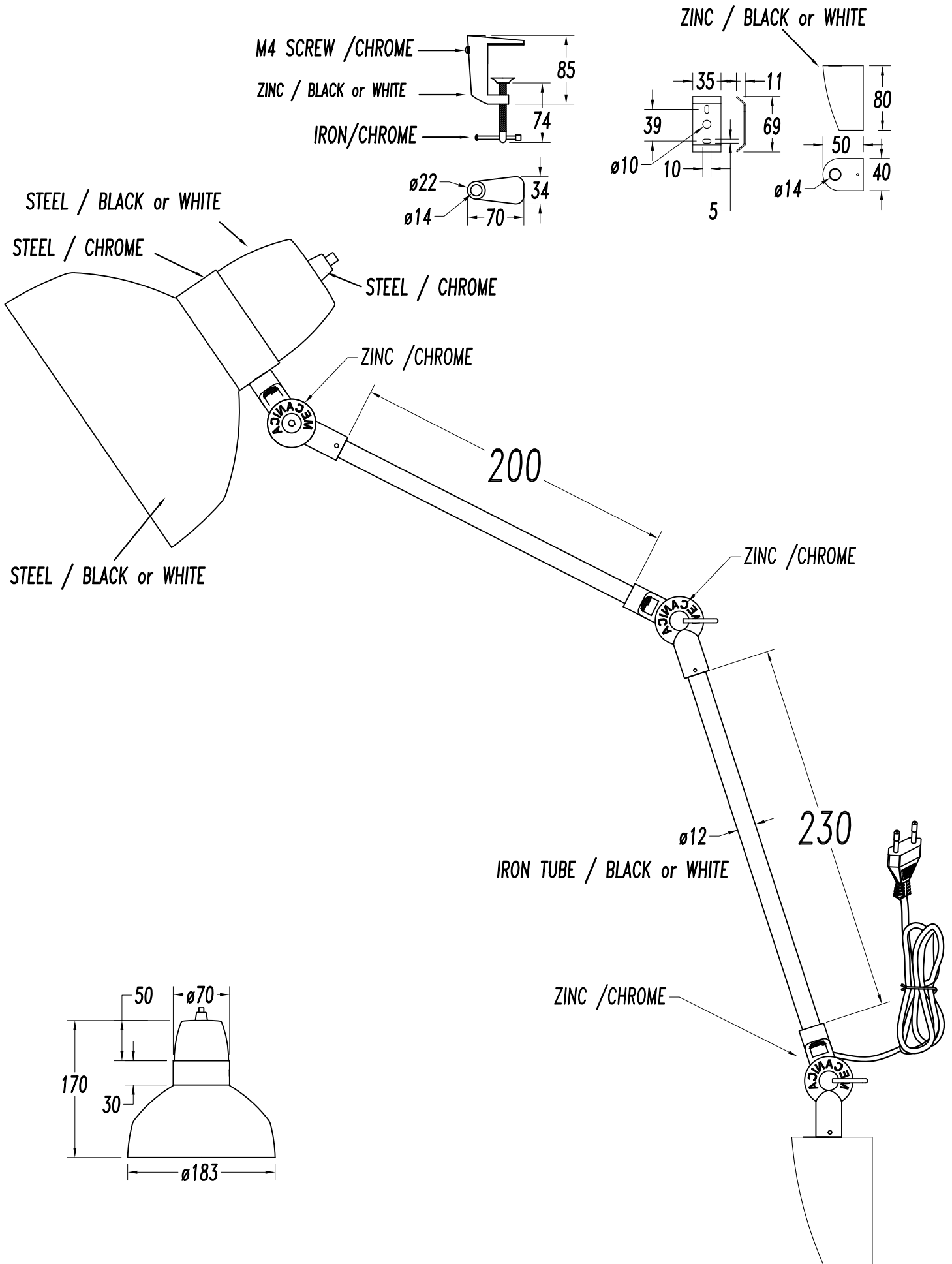

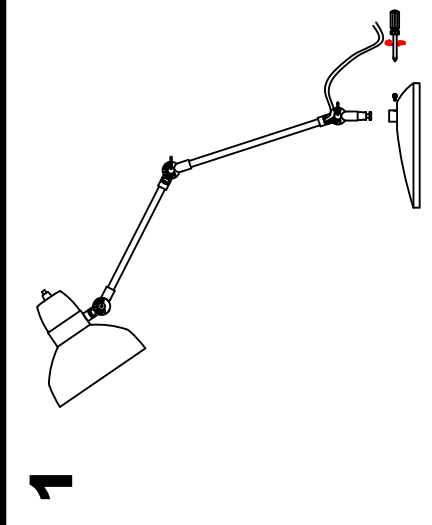
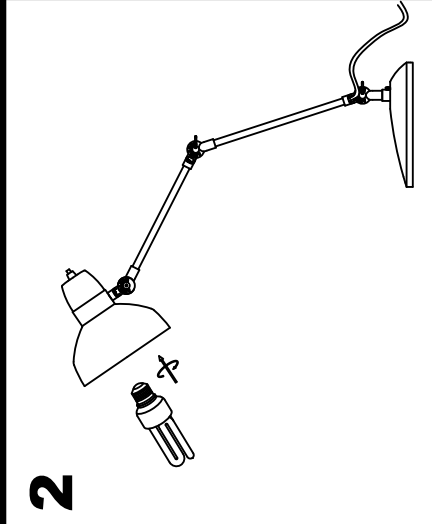
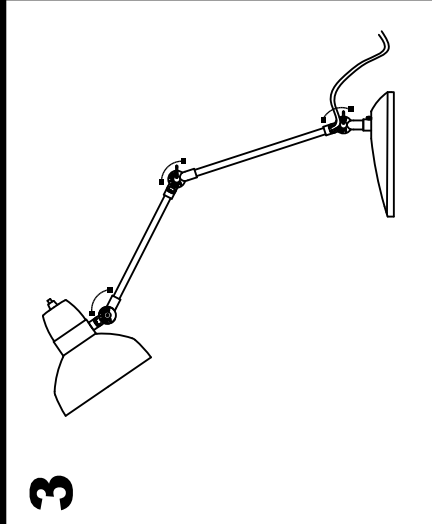
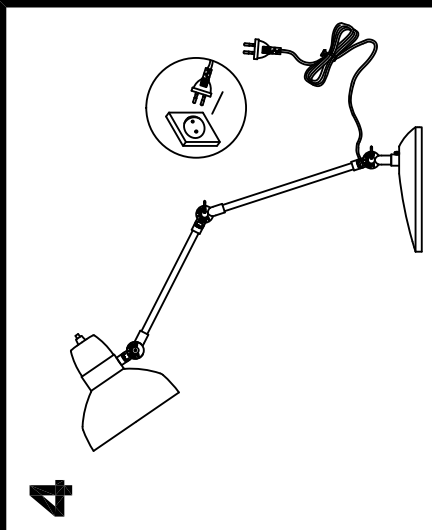
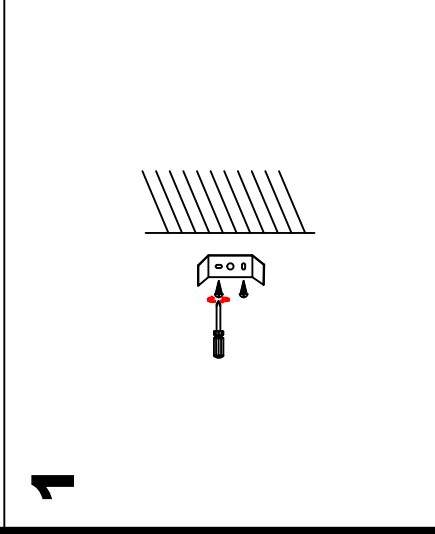
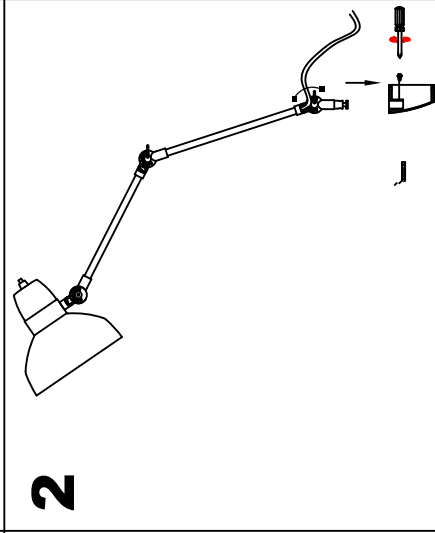
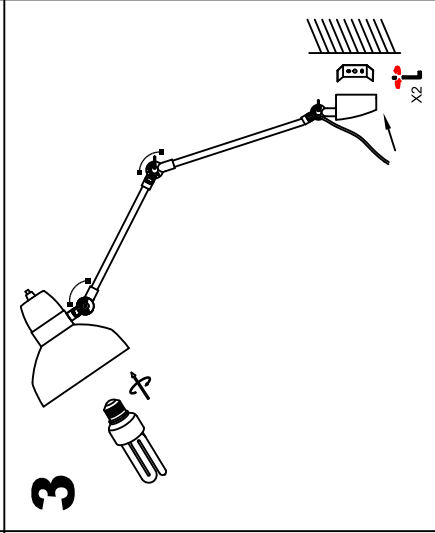
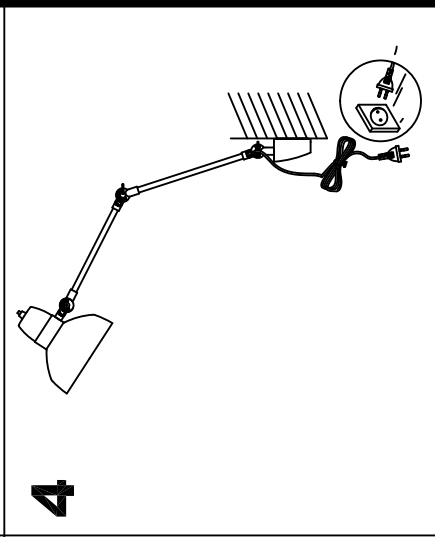
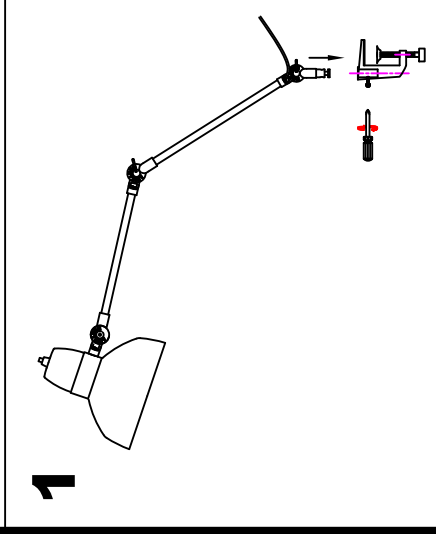
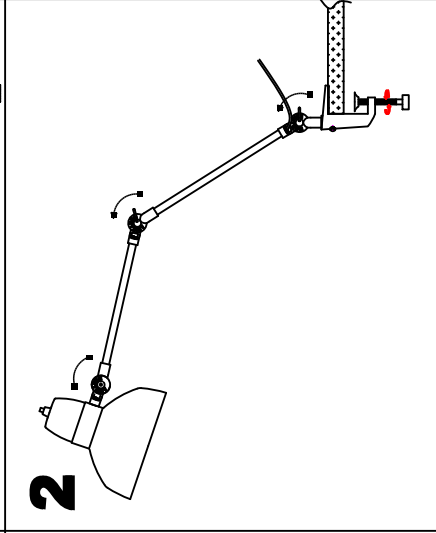
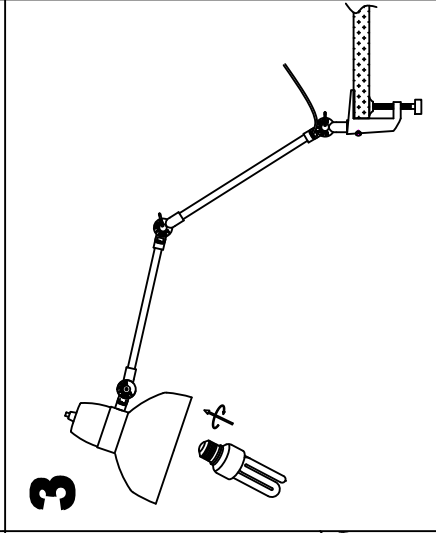
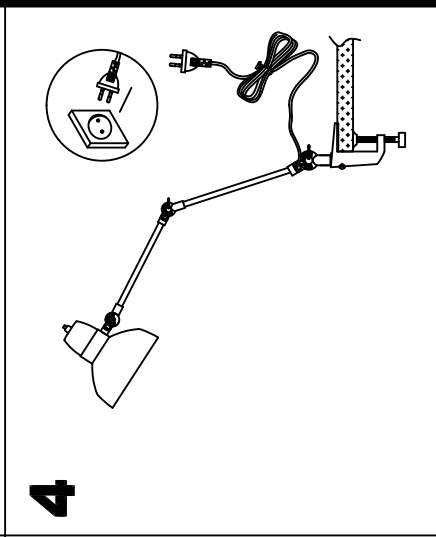
 <p><b>1</b></p>	 <p><b>2</b></p>	 <p><b>3</b></p>	 <p><b>4</b></p>
 <p><b>1</b></p>	 <p><b>2</b></p>	 <p><b>3</b></p>	 <p><b>4</b></p>
 <p><b>1</b></p>	 <p><b>2</b></p>	 <p><b>3</b></p>	 <p><b>4</b></p>