

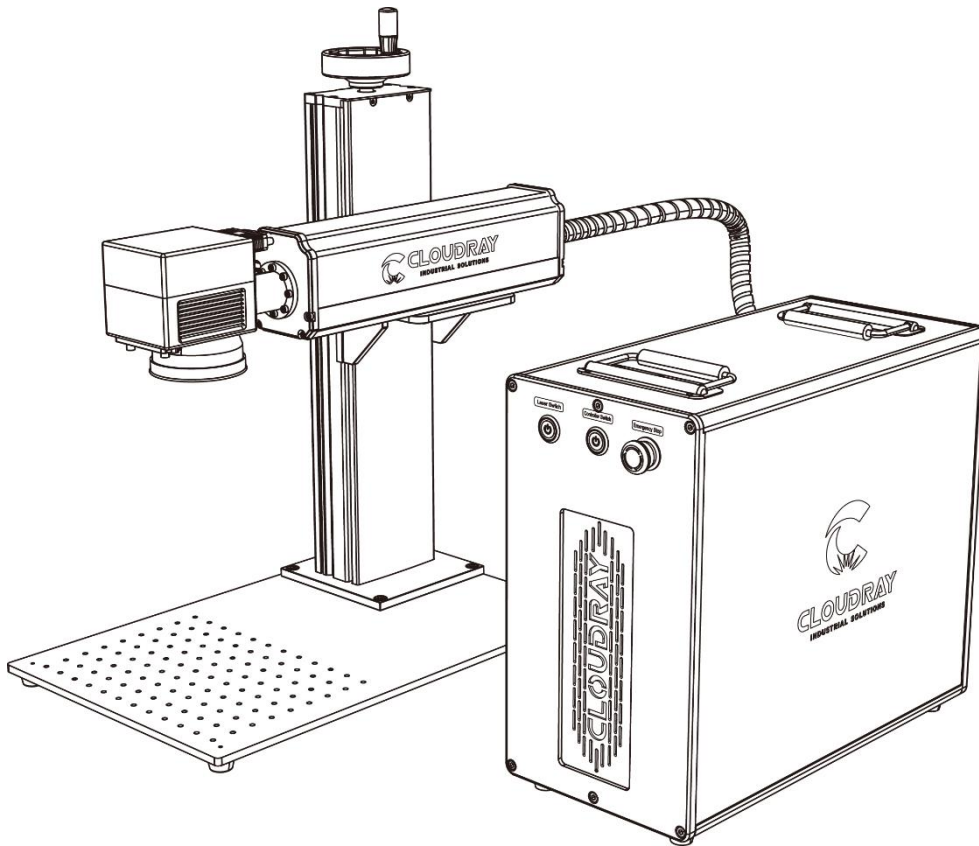

# LiteMarker Pro Laser System

## QS Series User Guide



Version 3.0(2023.05)

## PREFACE

### Dear Customer:

Thank you for choosing Cloudray Laser System.

This fiber laser marking machine is intended for personal and professional use.

Cloudray is committed to providing the highest level of customer satisfaction and support. To ensure a favorable customer experience, we kindly suggest that the customer can thoroughly read the **User Guide** provided with your equipment before using it.

Your usage experience and suggestions will be essential for Cloudray to improve our product and service.

Tell us about your experience with Cloudray Laser Machine at [info@cloudray.com](mailto:info@cloudray.com). What's more, you can earn \$50-\$300 Cashback by sharing your buyer show and Usage Report (download on the product page).

Join our Facebook group to learn more laser general knowledge and discuss with more people in the laser industry. Join in Cloudray Forum to find laser machine solutions.

Facebook Group: <https://www.facebook.com/groups/cloudray>

Cloudray Forum: <https://forum.cloudray.com/>

Should you have any questions, you can get support from Cloudray Official Customer Support with any of following contact.

Email: [info@cloudray.com](mailto:info@cloudray.com)

Skype: [info@cloudray.com](https://www.skype.com/people/info@cloudray.com)

WhatsApp: +86 153 3512 0540.

Again, thank you for choosing Cloudray.

Sincerely,

**Cloudray Official Team**



Cloudray cannot be held responsible for any direct or indirect damages, which result from using or working with the products electric circuits or software described herein. The apparatus must be used only by trained and skilled personnel. Before use the manual should be read and followed carefully.

Furthermore, Cloudray reserves the right to change or alter any product described herein without prior notice.

## Document History

Version	Date	Content
V2.0	04/2022	V2.0 official version released
V2.1	04/2022	Fix some formatting errors
V2.2	11/2022	Renew some pic.
V3.0	04/2023	Fix some formatting errors, renew some pic.

# CONTENTS

1. General Information.....	1
1.1. Meaning of symbols and notes .....	1
1.2. Designated Use.....	2
1.3. Disposal Remarks .....	3
1.4. Manufacturer's Label .....	3
1.5. EC–Declaration of Conformity .....	4
1.6. Complementary Documentation .....	5
2. Safety Information .....	6
2.1. Disclaimer .....	6
2.2. General Safety Instructions .....	6
2.3. Laser Safety Instructions .....	7
2.4. Electrical Safety Instructions.....	8
2.5. Material Safety Instructions .....	8
3. Technical Specifications .....	11
4. System Overview .....	12
4.1. Control Elements on the Front.....	13
4.2. Laser Module Interface .....	13
4.3. Laser Module (Inside).....	14
5. Installation.....	15
5.1. Installation Overview .....	15
5.2. Location Selection .....	15
5.3. Electrical Grounding .....	16
5.4. Assembly Instructions.....	16
5.5. Control Computer Installation .....	18
6. Operation .....	19
6.1. Operation Overview.....	19
6.2. Software Installation .....	19

6.2.1. Driver Installation.....	19
6.2.2. Drive Uninstallation.....	21
6.3. EZCAD main interface view.....	24
6.3.1. Marking parameter .....	24
6.3.2. Laser Marking Control Bar.....	25
6.4. Focusing.....	25
6.5. Rotary attachment (option) .....	26
6.5.1. Mounting the work piece in the rotary attachment.....	27
6.5.2. Text rotate marking.....	27
6.5.3. Vector file rotate marking.....	31
7. 1st Marking Job .....	34
8. Instructions for Specific Materials .....	38
8.1. Metals.....	38
8.2. Plastics.....	38
8.3. Stone.....	39
9. Maintenance.....	40
9.1. Maintenance Overview .....	40
9.2. Regular Maintenance Procedures .....	40
9.3. Cleaning the Lenses.....	41
9.4. Troubleshooting Guidance.....	42

# 1. General Information

This manual is the designated user guide for the installation, setup, safe operation, and maintenance of your fiber laser marking machine. It is divided into six chapters covering general information, safety instructions, installation steps, operation instructions, maintenance instructions, and contact information.

All personnel involved in the installation, setup, operation, maintenance, and repair of this machine should read and understand this manual, particularly its safety instructions. Substandard performance and longevity, property damage, and personal injury may result from not knowing and following these instructions.

Your fiber laser marker works by emitting a powerful laser beam from its fiber laser source, sending that beam through a fiber optic cable, focusing its power through the galvo lens, and using this focused light to etch designs into certain substrates.

This fiber laser marking machine uses a nanoscale fiber laser source. Its single-mode output, good heat dissipation, high efficiency, and compact structure make it ideal for high-precision laser marking. With typical use, this device has an average lifespan around 100,000 working hours. However, constantly running your laser above 80% of its maximum rated power can significantly shorten its service life. It is recommended to use settings from 10–75% of the maximum rated power to enjoy optimal performance and longevity.

Note that this is a high-voltage device and, as a safety precaution, it is recommended to only touch its components with one hand at a time during use.

Note also that this device does not have a protective housing. It is thus recommended to use a special room or to raise protective screens around the work area. The active laser is invisible to the human eye and anyone in or near the working area **MUST** use special protective eyewear when the laser is in use to avoid potentially permanent injury.

## 1.1. Meaning of symbols and notes

Important technical safety notes and instructions in this manual are indicated by symbols. It is important to observe and follow these notes and instructions on workplace safety. Avoid accidents, personal injury, and material damage to property by acting with extreme caution.



### Caution!

This symbol indicates a potentially hazardous situation. Not observing these notes may result in personal injury or damage to equipment.



**Caution!**  
 Dangerous electrical voltage - indicates a risk of electric shock and warns of imminent danger to the life and health of individuals or of significant damage to equipment.



**Caution!**  
 Laser beam - means that the laser machine may operate in laser class 4 when commissioning the laser head. Warns of damage to eyes or skin caused by direct or scattered radiation.



**Important:** Information the user must observe or know to avoid process disruptions or malfunctions when using the product.



**Tip:** Gives the user the information needed to achieve the objective directly and without problems.



Protective eyewear should be worn by anyone around this machine during operation.



This product contains electrical components that should not be disposed of with regular garbage.

## 1.2. Designated Use

This machine is intended for use engraving signs and other consumer products on applicable substrates. This laser can process a wide variety of metals including steel, aluminum, titanium, brass, copper, tungsten, carbide, and chrome. It can also be used with stone and some hard plastics such as acrylic. (See 2.5 & 4.3 for further details.) Use of this system for non-designated purposes is not permitted.

The system must be operated, maintained, and repaired by personnel familiar with the field of use and the dangers of the machine and the material being engraved including its reflectivity, conductivity, potential for creating harmful or combustible fumes, etc.

Laser beams are dangerous. The manufacturer and/or seller bear(s) no responsibility and assume(s) no liability for any improper use of this device or for any damage or injury arising from such use. The operator is obliged to use this fiber laser marker only in accordance with

its designated use, the other instructions on the device and in its manuals, and all applicable local and national laws and regulations.

### 1.3. Disposal Remarks



Do not dispose the machine with domestic waste!  
Electronic devices have to be disposed according to the regional directives on electronic and electric waste disposal.

### 1.4. Manufacturer's Label

The Manufacturer's Label is located on the side/backside of the machine (see picture below)

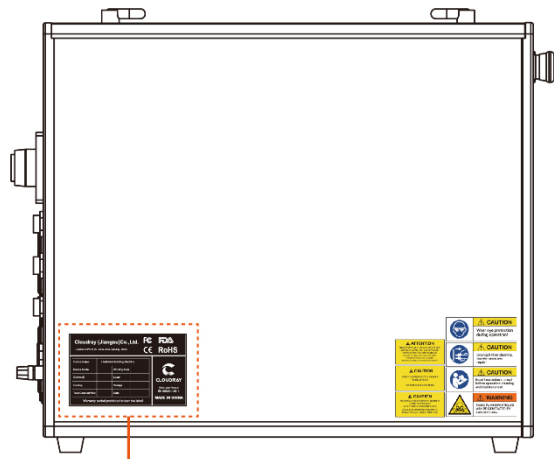
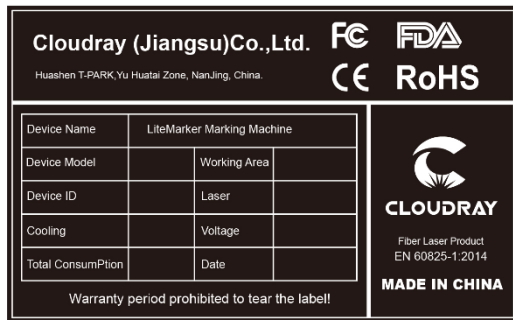



## 1.5. EC–Declaration of Conformity

<b>Declaration of Conformity</b>		
<b>For the following equipment :</b>		
<b>Product Name :</b> Laser Marking Machine		
<b>Model Name:</b> CLM20F, CLM30F, CLM50F, CLM60F, CLM80F, CLM100F, CEM20F, CEM30F, CEM50F, CEM60F, CEM80F, CEM100F, CAM20F, CAM30F, CAM50F, CPM20F, CPM30F, CPM50F, CPM60F, CPM80F, CPM100F, CUM20F, CUM30F, CUM50F, CUM60F, CUM80F, CUM100F, C3DM30F, C3DM50F, CLM03U, CLM05U, CLM10U, CLM40C, CLM60C, CUM40C, CUM60C, C3DMCO2		
<b>Applicant:</b>	Cloudray (Jiangsu) Co., Ltd.	
<b>Address:</b>	Room 101, 3-A, No.10 Huashenmiao, Huashen T-Park, Yuhuatai Zone, Nanjing, Jiangsu, China 210012	
<p>Is herewith confirmed to comply with the requirements set out in the Council Directive on the Approximation of the Laws of the Member States relating to Electromagnetic Compatibility (2014/35/EU and 2006/42/EC Directive) For the evaluation regarding the electromagnetic compatibility , the following standards were applied:</p>		
EN 60825-1:2014 LVD EN 60204-1:2018 EN ISO 12100:2010		
The following manufacturer/importer is responsible for this declaration: Person responsible for marking this declaration:		
Nanjing, China 14.10.2022	Rayner DING General Manager	

## 1.6. Complementary Documentation

Complementary documentation can be found on the supplied U disc.

### **Software:**

EZCad2.14.11 (Different Lens Software)

EZCad2\_EN\_Manual

USB Driver

Cor File

### **\*RS232 File:**

For50QB (PulseQLasterTest)

RS232 Cable Driver & Manual

**\*Notice:** RS232 files only for QS series 50W marking machine.

### **Operation Manual:**

USB Driver and Software Install V2

Settings after change F-theta lens

Laser marking machine install drive and rotary

Instructions for Rotating Marking

### **Videos:**

USB Driver Install

USB Driver Uninstall

How to Use Rotary

Core File Import

Lightburn Install

How to use 9 Points Correction

## 2. Safety Information

### 2.1. Disclaimer

Your engraver may differ somewhat from those shown in this manual due to options, updates, etc. Please contact us if your marking machine came with an outdated manual or if you have any other questions.

### 2.2. General Safety Instructions

- Use this laser marking device only in accordance with all applicable local and national laws and regulations.
- Use this device only in accordance with this instruction manual and the manual for the engraving software included with it. Only allow this device to be installed, operated, maintained, repaired, etc. by others who have also read and understood both manuals. Ensure that this manual and the software manual are both included with this device if it is ever given or sold to a third party.



- DO NOT operate this device continuously for more than 5 hours. Stop every 5 hours for at least ½ hour.
- DO NOT leave this device unattended during operation. Observe the device throughout operation and, if anything seems to be operating strangely, immediately cut off ALL power to the machine and contact either our customer service or your dedicated repair service. Similarly, ensure the device is FULLY turned off in the correct order after each use.
- DO NOT allow minors, untrained personnel, or personnel suffering from physical or mental impairment that would affect their ability to follow this manual and the software manual to install, operate, maintain, or repair this device.
- Any untrained personnel who might be near the device while it is in operation MUST be informed that it is dangerous and fully instructed on how to avoid injury during its use.
- Always keep a fire extinguisher, water hose, or other flame retardant system nearby in case of accidents. Ensure that the local fire department's phone number is clearly displayed nearby. In the case of a fire, cut electrical power before dousing the flame. Familiarize yourself with the correct range for your extinguisher before use. Take care not to use your extinguisher too close to the flame, as its high pressure can produce blowback.

## 2.3. Laser Safety Instructions

This machine uses an invisible CLASS 4 LASER, the strongest and most dangerous class of laser available for public use. Used without care, it can cause serious property damage and personal injury including but not limited to the following:



- The laser will easily burn nearby combustible materials
- Some working materials may produce radiation or harmful gasses during processing
- Direct exposure to the laser will cause bodily harm including serious burns and irreparable eye damage

As such,

- NEVER interfere with the laser beam.
- DO NOT place any part of your body under the laser lens during operation. Take measures to protect yourself from potentially reflected laser beams including the use
- NEVER attempt to view the laser directly without protective eyewear. Always wear safety goggles or glasses designed to filter the specific wavelength of your engraver's laser with an optical density (OD) of 5+. As even seemingly matte materials can produce harmful reflected beams, care should be taken to keep anyone without protective eyewear from observing the machine during operation. EVEN WITH protective eyewear, do not stare or allow others to stare continuously at the laser beam during operation.
- DO NOT leave potentially combustible, flammable, explosive, or corrosive materials nearby where they could be exposed to the direct or reflected laser beam.
- DO NOT use or leave sensitive EMI equipment nearby. Ensure the area around the laser is free of strong electromagnetic interference during any use.
- ONLY use this machine as described in the Material Safety section of this manual. The laser settings and engraving process must be properly adjusted for specific materials.
- Ensure the area is kept free of airborne pollutants, as these might pose a similar risk of reflection, combustion, etc.
- NEVER use this marking machine with the fiber source's housing opened, as the closed laser light path is necessary to prevent laser radiation leakage.
- DO NOT modify or disassemble the laser and do not use the laser if it has been modified or disassembled by anyone except trained and skilled professionals. Dangerous radiation exposure and other injury may result from the use of adjusted, modified, or otherwise incompatible equipment.

## 2.4. Electrical Safety Instructions

- ONLY use this device with a compatible and stable power supply with less than 5% fluctuation in its voltage.



DO NOT connect other devices to the same fuse, as the laser system will require its full amperage. Do not use with standard extension cords or power strips. Use only surge protectors rated over 2000J.

- ONLY turn on the power to this device when it is well grounded, either via a firm connection to a 3-prong outlet or via a dedicated grounding cable firmly connected to the proper slot on the back of the main tower. Do not use with an ungrounded 3 to 2 prong adapter. The device's grounding should be checked regularly for any damage to the line or loose connections.
- Turn the device on and off using its key and power buttons in the correct order. The mainboard, galvo, and laser have separate power supplies that are grounded in order. Activating everything at once, too quickly, or in the wrong order may send electrical current to an ungrounded component, causing short circuits and other electrical hazards.
- ONLY use this device with one hand at a time. The laser is powered by an extremely high voltage connection and placing two hands on the machine at one time during operation has the potential to create a closed circuit with the human body, resulting in electrical shock.
- The area around this laser marking device should be kept dry, well ventilated, and environmentally controlled to keep the ambient temperature between 40–95°F (5–35°C). The ambient humidity should not exceed 70%.
- Adjustment, maintenance, and repair of the electrical components of this device must be done ONLY by trained and skilled professionals to avoid fires and other malfunctions, including potential radiation exposure from damage to the laser components. Because specialized techniques are required for testing the electrical components of this marking system, it is recommended such testing only be done by the manufacturer, seller, or repair service.
- Unless otherwise specified, ONLY undertake adjustment, maintenance, and repair of the device when it is turned off and disconnected from its power supply.

## 2.5. Material Safety Instructions

- Users of this fiber marking machine are responsible for confirming that materials to be processed can withstand the heat of a class 4 laser and will not produce any emissions or

byproducts either harmful to people nearby or in violation of any local or national laws or regulations. In particular, do not use this device to process polyvinyl chloride (PVC), TEFLON, or other halogen containing materials under any circumstances.

- Users of this fiber laser are responsible for ensuring that every person present during operation has sufficient PPE to avoid any injury from emissions or byproducts of the materials being processed. In addition to the protective laser eyewear discussed above, this may require goggles, masks or respirators, gloves, and other protective outer clothing.
- Users must exercise special caution when working with conductive materials as buildup of their dust and ambient particles may damage electrical components, cause short circuits, or produce other effects including reflected laser radiation.

This machine can be safely used with the following materials:

- Aluminum
- Brass
- Carbide
- Gold
- Silver
- Steel
- Stone, including Granite, Marble, etc.
- Titanium
- Tungsten

This machine can be used with some other metals, hard plastics, and other materials with some care. For other materials, if you are unsure about its safety or laser ability with this device, seek out its material safety data sheet (MDS). Pay especial attention to information about safety, toxicity, corrosiveness, reflectivity, and reaction(s) to high heat. Alternatively, contact our support department for further guidance.

This machine **CANNOT** be used with the following materials or with any materials which include them:

- Artificial Leather containing Hexavalent Chromium (Cr [VI]), due to its toxic fumes
- Astatine, due to its toxic fumes
- Beryllium Oxide, due to its toxic fumes
- Bromine, due to its toxic fumes
- Chlorine, including Polyvinyl Butyral (PVB) and Polyvinyl Chloride (PVC, Vinyl, Cintra, etc.), due to its toxic fumes
- Fluorine, including Polytetrafluoroethylenes (Teflon, PTFE, etc.), due to its toxic fumes

---

## Cloudray Laser System

---

- Iodine, due to its toxic fumes
- Paper and Paperboard, due to their high flammability when exposed to the concentrated laser
- Phenolic Resins, including various forms of Epoxy, due to their toxic fumes
- Wood, including MDF, Plywood, Balsa, Birch, Cherry, Oak, Poplar, etc., due to its high flammability

### 3. Technical Specifications

**→ Laser**

Laser (maintenance free)	Q-pulsed Fiber Laser	
Laser power (Depending on model)	30W	50W
Wavelength	1060 - 1085 nm	
Frequency (kHz)	30 - 60	50 - 100
Pulse width	130 - 160 ns @40kHz	120 - 150 ns @50kHz
Cooling	Air cooled (filters)	

**→ Galvo Scanner**

Marking area	F-160	F-290
	110 x 110mm	200 x 200mm
Focus diameter	~ 35 µm	~ 65 µm
Writing speed	640 cps (1mm single stroke with F=160mm)	
Max marking speed	2000mm/s	
Positioning speed	10m/s with F=160mm	

**→ Control**

Computer	Microsoft Windows XP, VISTA, Win7, Win10, Win11
Interfaces	USB
Marking software	EZCad2 (Standard) / EzCad3 (Optional)
Correction software	CorFile2
Laser power	Adjustable from 1 - 100%

**→ Ambient Conditions**

Ambient conditions	Operating temperature +5 to +35° C.
	Relative humidity max. 90 %.
	Non-condensing
Power requirements	110-230V AC, 50/60Hz, single-phase
Power consumption	Max. 600 W
Equipment protection	IP54 (Marking head), IP20 (Laser unit)



## 4. System Overview

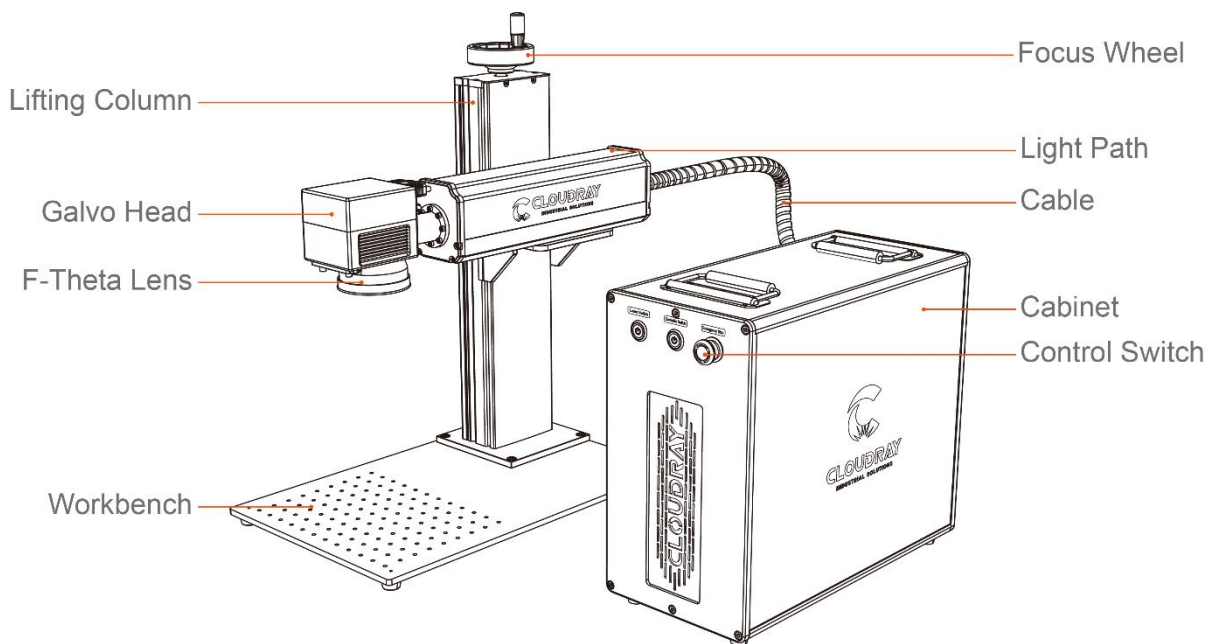

### Main Parts

**Cabinet**—Contains controllers, lasers, power supply units, etc.

**Galvo Head**—Focuses the laser beam to a fine point, directing it to proper locations on the target material during engraving.

**Workbench**—This platform holds the target material, with optional positioning bars to ensure precise alignment.

**Fiber Cable**—This transmits the laser beam from its source to the galvo lens.

**Lifting Column**—Lifting column holds the laser arm and includes a precise graduated rule for quickly adjusting height to work with different materials and thicknesses.

**Focus Wheel**—This wheel moves the laser arm up and down for the correct alignment across different materials and thicknesses.

**F-Theta Lens**—Focused beam is the strongest energy point.

**Control Switch**—Laser marking machine start-stop control switch.

**Light Path**—Internal isolator with laser, red light and beam combiner (some models).

## 4.1. Control Elements on the Front

**Laser Switch**—Activates the fiber laser power. Press this last during startup and first during shutdown.

**Controller Switch**—Activates the controller and galvo power. Press this second during startup and shutdown.

**Emergency Switch**—Activates the machine main power. Rotate this first during startup and press during shutdown. In case of emergency, press to cut off the power at any time.

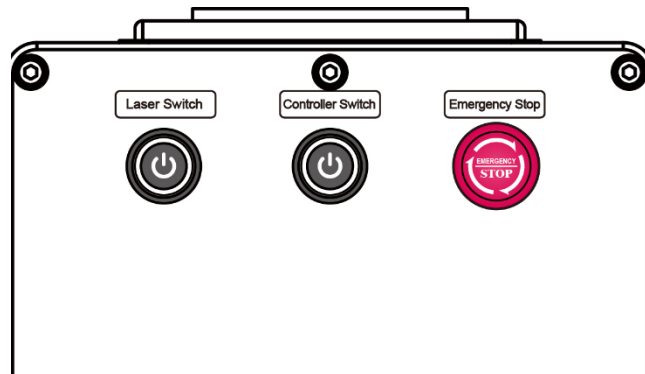

## 4.2. Laser Module Interface

**PC-USB**—This port connects the device to your control computer.

**Spare Port**—Alternate port, used if necessary.

**Rotary (Optional)** —This port enables use of a rotary axis engraver with a 4-pin connection cable. (Compatible rotary axis devices are sold separately.)

**Foot Switch**—This port enables optional pedal control of laser activation to free your hands for manual adjustment of the target material.

**Power Input**—This 3-pin port connects to the device's standard 3-prong power cord (Voltage and power cord types are standard according to actual conditions)

**Ground Pole**— This pole used to introduce current into the ground; when the electrical equipment leaks or the voltage is too high, the current enters the ground through the ground.

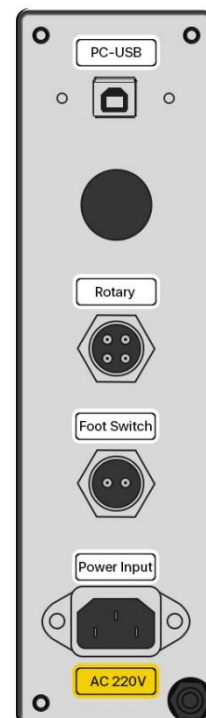

### 4.3. Laser Module (Inside)

- A. **Relay**—Used for switching circuit control conversion.
- B. **Controller**—Cooperates with the software to control the laser and galvo to work.
- C. **Stepper Driver**—Control rotary work and realize rotary marking function.

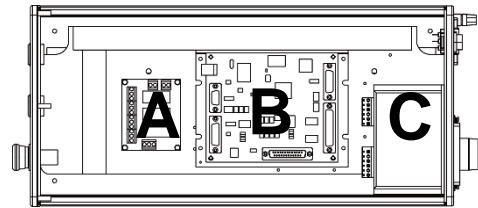

- D. **5V Power Supply**—Provide 5V power for the controller.
- E. **±15V Power Supply**—Provide ±15V power to galvo.
- F. **24V Power Supply1**—Provides 24V power for relay.
- G. **24V Power Supply2**—Provides 24V power for fiber laser and fans.

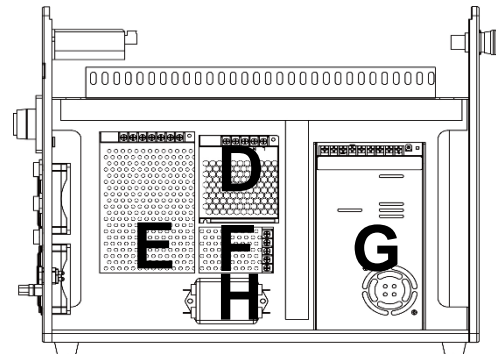

- H. **Filter**—Filter signal clutter to eliminate interference to control signals.

- I. **Fiber Laser**—Provide laser source.
- J. **Fans**—Provide heat dissipation for cabinet.

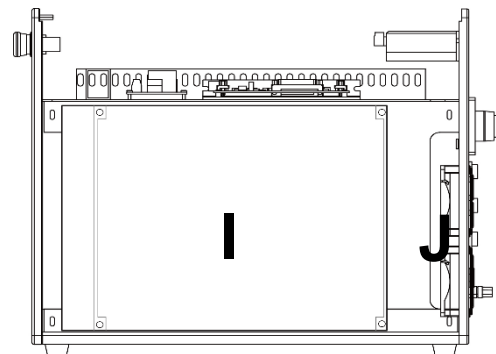

## 5. Installation

### 5.1. Installation Overview

A complete working system consists of the fiber laser source, the laser arm with the galvo lens, the laser key, a computer (not included) with engraving software (included), and all applicable connection cables. A support column and workbench come included to assist your work. Users can also configure other additional accessories (such as a rotary axis) to suit their needs.



Use only the hardware, wiring, and power sources that came with or are compatible with this device. Installing equipment that your device is not designed to work with can lead to poor performance, shortened service time, increased maintenance costs, property damage, and personal injury.

Please note the specific requirements of your system's installation. Every customer must understand these notes before installation to execute a proper setup and achieve safe laser performance. If you have any installation questions or problems, contact our technicians and customer support team.

Any auxiliary equipment must be adjusted to the base machine. Queries may be directed to the dealer or manufacturer of such equipment.

### 5.2. Location Selection

Prior to assembling your fiber laser marker, select an appropriate location for its use.

Be sure that it meets all of the requirements discussed in the Safety Information above. The location should be stable, level, dry, and climate controlled to ensure an ambient temperature 40–95°F and an ambient humidity under 70%. In particular, the temperature and humidity together should not be close to the dew point. It is also advisable to use a windowless room or to use blinds and/or curtains to avoid exposure to the potential additional heat of direct sunlight. The location should be free of dust and other airborne pollutants and well ventilated enough to process any fumes produced by the engraving process in accordance with all applicable laws and regulations. Depending on the materials to be processed, this may require construction of a dedicated ventilation system. It should be away from children; combustible, flammable, explosive, or corrosive materials; and sensitive EMI devices. The power cord should be plugged into a compatible and stable power source via a grounded 3-prong outlet. No other item should be drawing current from the same fuse. There should be fire-fighting equipment nearby and the local fire department's phone number should be clearly displayed.

It is highly recommended to have an extra work table nearby in order to avoid placing objects on or directly adjacent to the machine, which could become a fire or laser hazard.

### 5.3. Electrical Grounding

This device employs a class 4 laser. As discussed in the Safety Information above, it is extremely high voltage and potentially dangerous, so users must securely ground it to avoid the buildup of static electricity. Using a standard 3-prong outlet will provide sufficient grounding. If you do not have access to a 3-prong outlet, you **MUST** use the grounding cable and ensure its proper connection. The far end of the cable should be securely connected to a metal rod driven at least 8 feet (3 m) deep into soil located at least 5 feet (1.5 m) from the machine. The resistance along the line should be no greater than 5Ω.



Poor grounding **WILL** cause equipment failure and create a serious electrical shock hazard. The manufacturer and/or seller bear(s) no responsibility and assume(s) no liability for any damage, accidents, or injuries caused by bad grounding connections. service time, increased maintenance costs, property damage, and personal injury

### 5.4. Assembly Instructions

**Step 1.** Use 4Pcs M8x10 hex socket head cap head screws to fix the lifting column and the workbench.

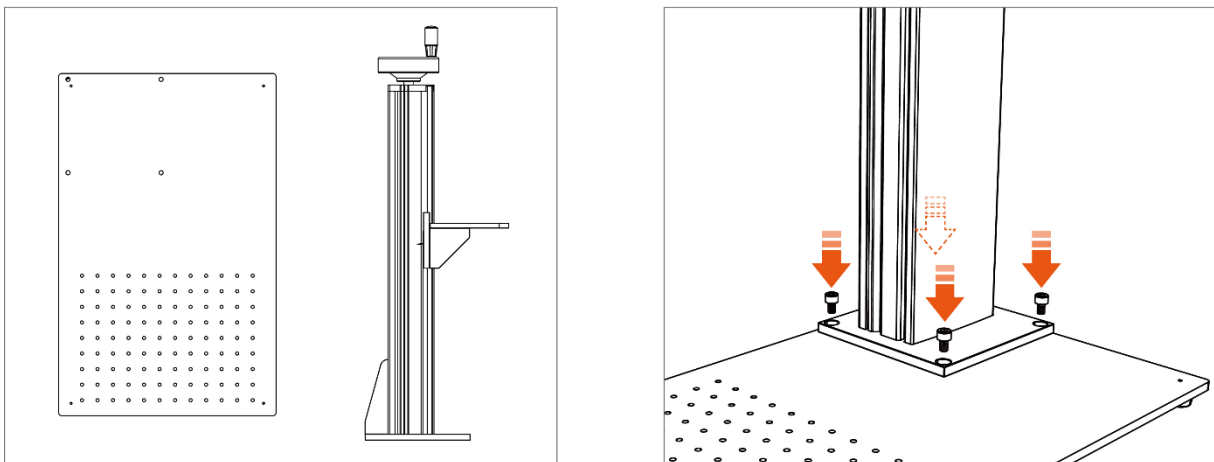

**Step 2.** Adjust the nut at the bottom of the light path to an appropriate position. Install the light path onto the lifting column using the provided screws. Tighten the four screws with the Allen key.

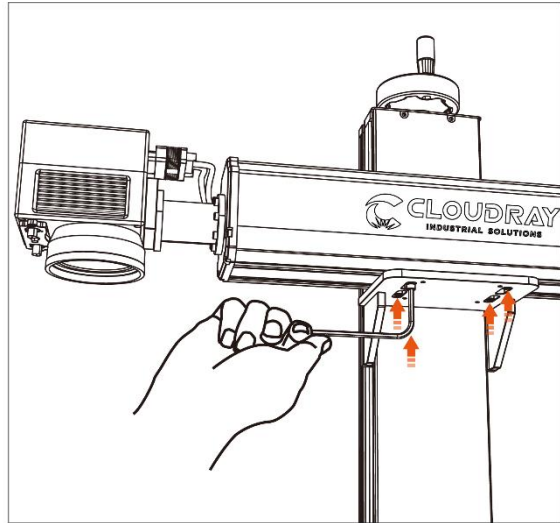
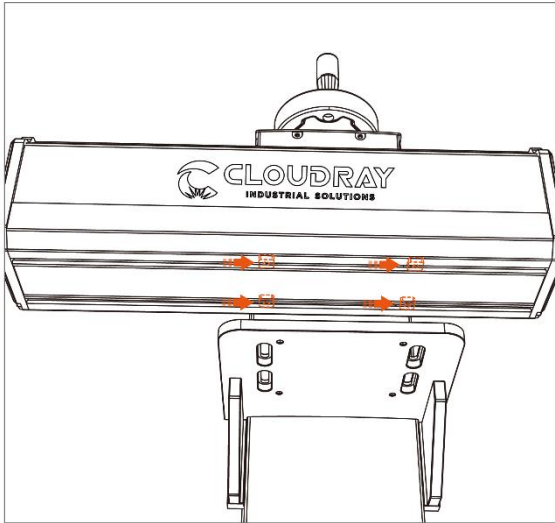

**Step 3.** Connect the USB-PC cable, Rotary cable, Foot Switch cable and Power cable.

**Note:** Rotary Attachment port is an optional port.

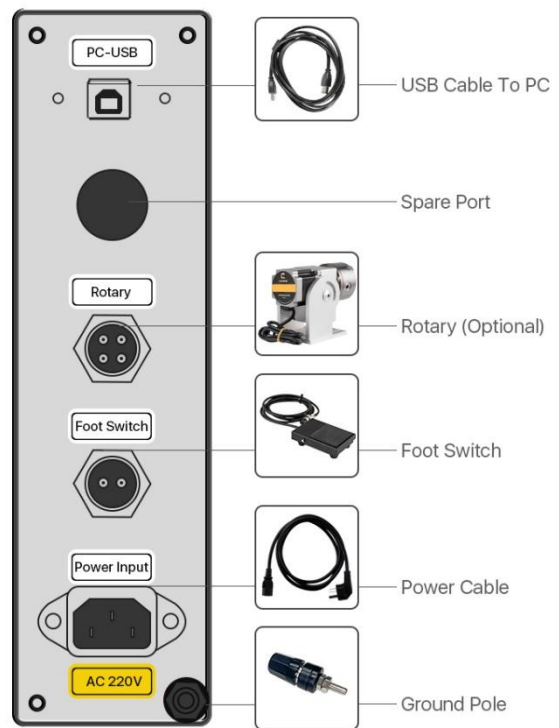

**Step 4.** Plug in the U disk (software, driver, electronic manual), and connect the USB cable to the PC.

**Step 5.** Remove the dust cover, start the device and turn on the red light under the galvo head.

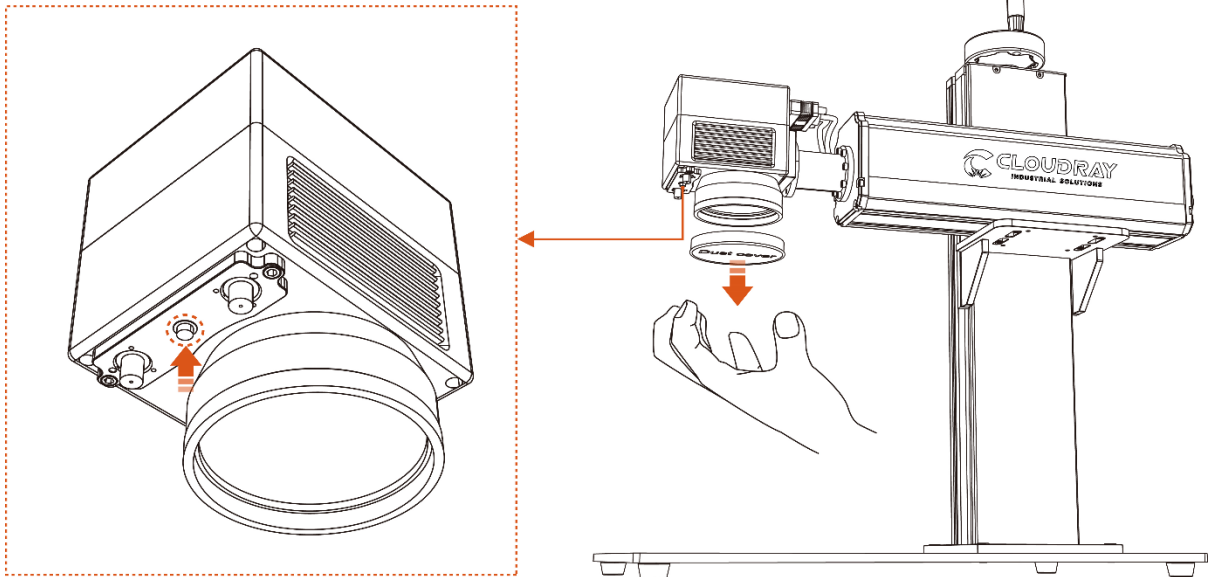

**Step 6.** Turn the focus wheel to adjust the two red dots to coincide to achieve focus.

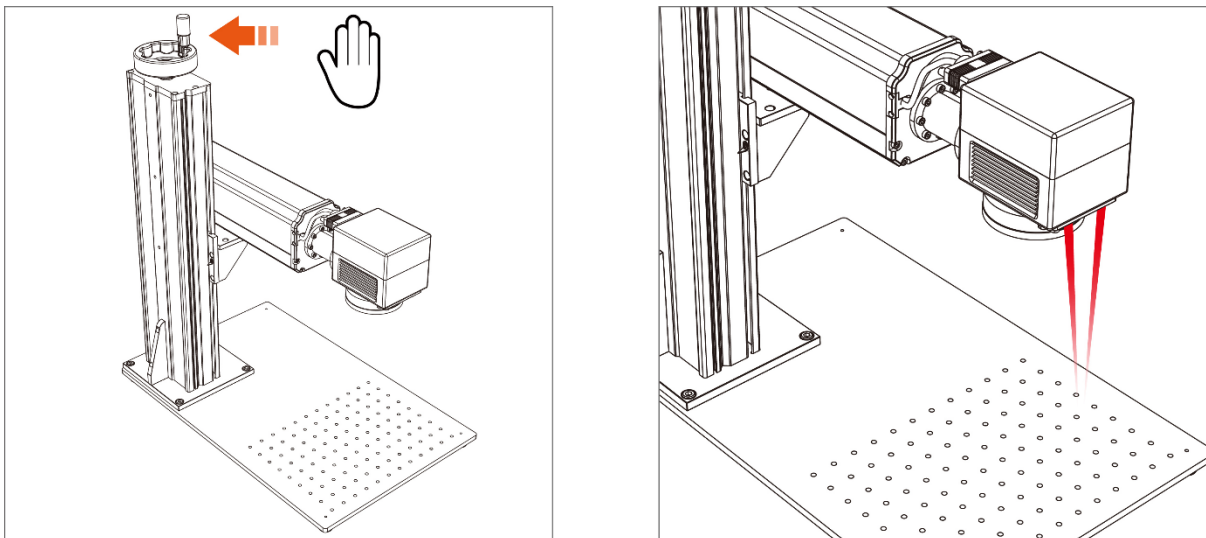

## 5.5. Control Computer Installation

The control computer should not be placed more than 15 feet (4.5 m) away from the fiber laser marker to avoid possible interference to the signal in its line. Familiarize yourself with your software's image design features and laser control settings before beginning operation of the laser itself.

## 6. Operation

### 6.1. Operation Overview



Operate this laser marking machine only in accordance with all the instructions provided in this manual. Failure to follow the proper guidelines detailed here can result in property damage and personal injury.

This section will address only some of the options and features provided by the operation software. Before beginning to use the machine, make sure that you have read this entire manual (particularly the Safety Information above), the separate software manual, and any and all warnings provided on the machine itself.

### 6.2. Software Installation

#### 6.2.1. Driver Installation

- Turn on the fiber laser.
- Connect your fiber laser and PC via USB cable.
- Start Windows.
- Go to “Windows Settings”. Search “Device Manager” and open it.

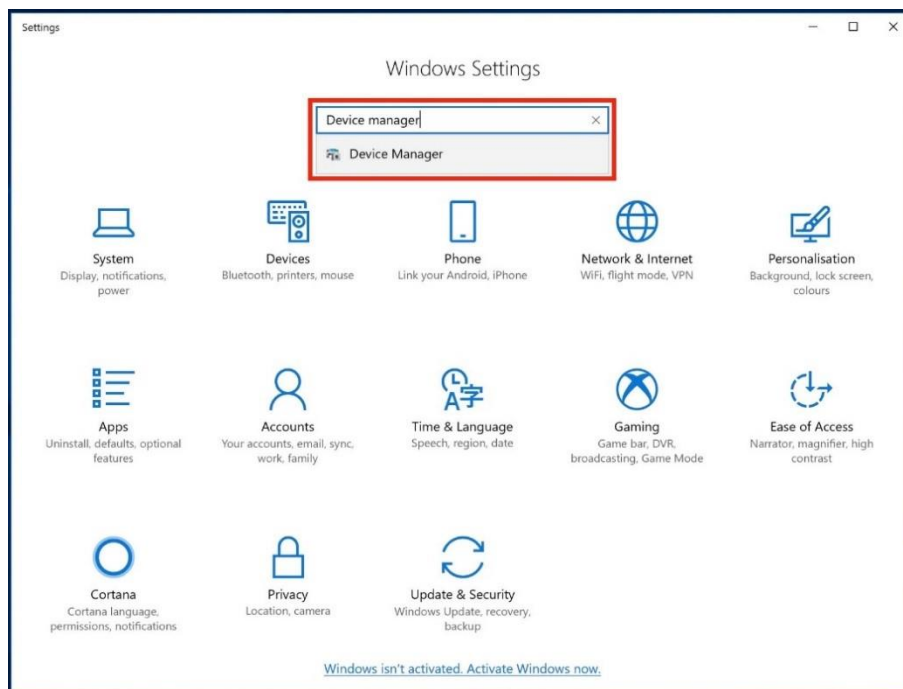



- Click “Other devices”>> USBLMCV2 >> Update driver (right click).

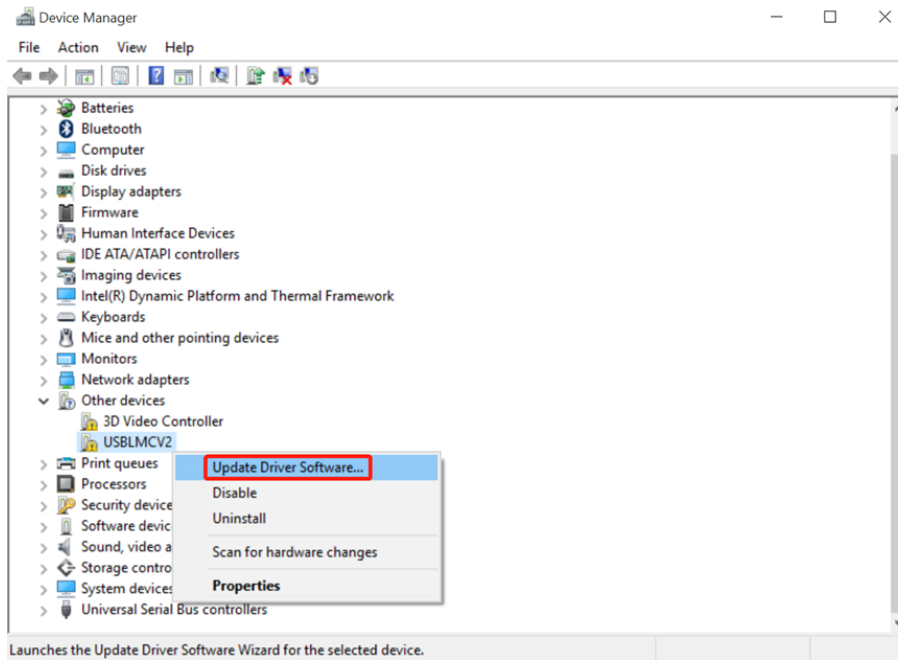

- Click “Browse my computer for driver software”.

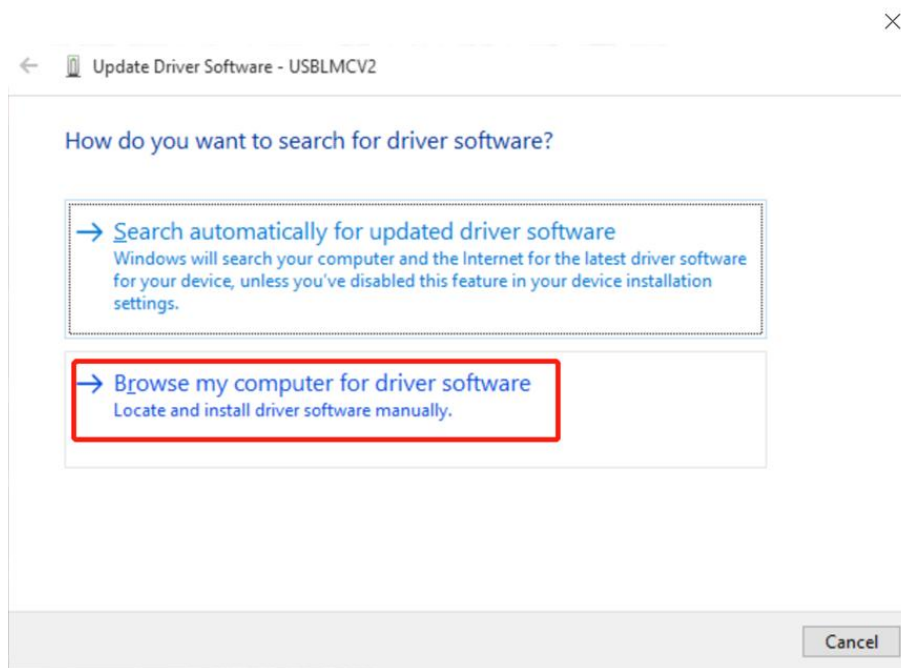

- Select the correct drive folder’s location.

Please select the subdirectory of the last level. And do not select zipped up or compressed folders.

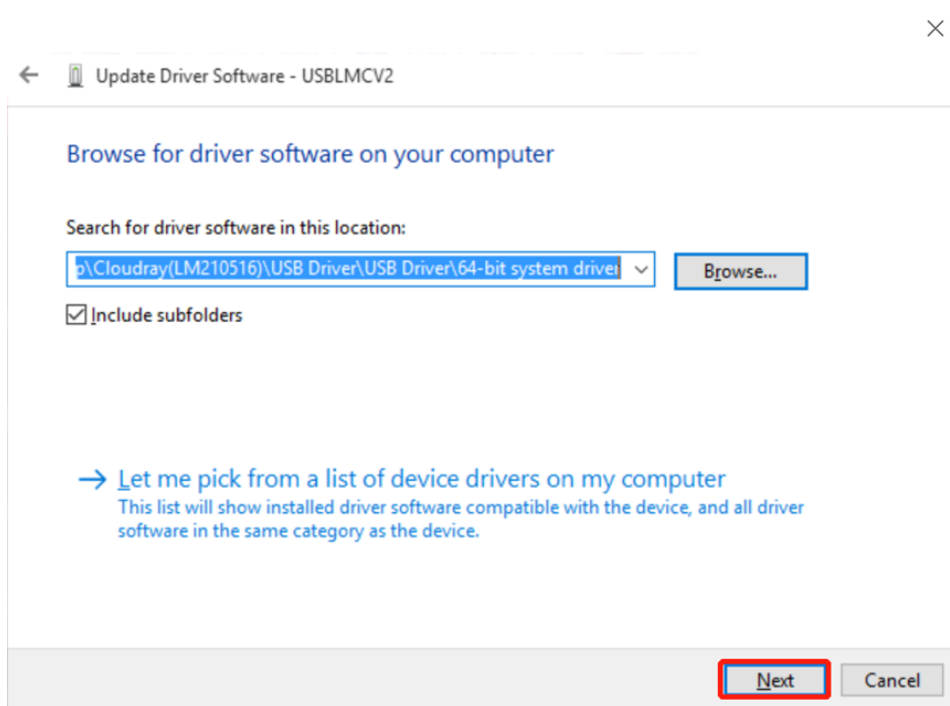

- Congratulations. You have finished installing the drivers for this device.

### 6.2.2. Drive Uninstallation

Because of the diversity of windows and hardware versions, drivers are often installed incorrectly (as shown below). At this time, we need to uninstall the driver originally installed before installing another driver.

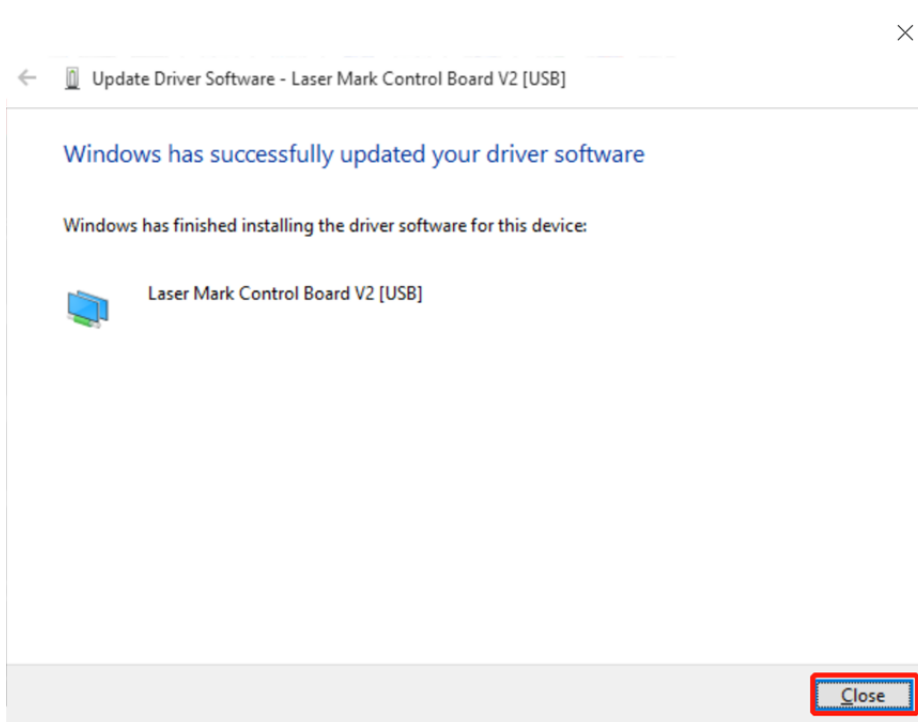

- Go to “Windows Settings”. Search “Device Manager” and open it.
- Click Other devices>> USBLMCV2 >> Uninstall device (right click).

**Notice:** Before install LightBurn need to uninstall this driver of EzCad.

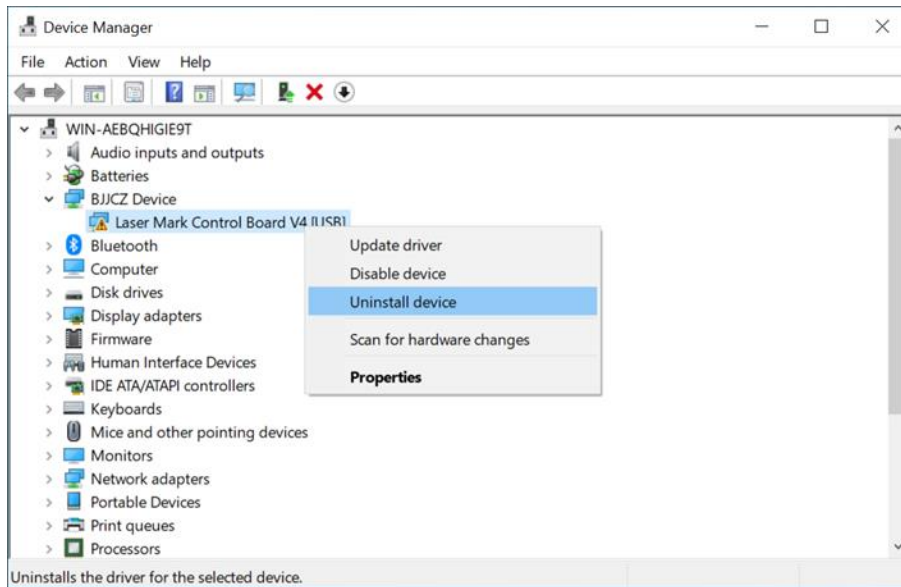

- Enable “Delete the drive software for this device” in the pop-up window.

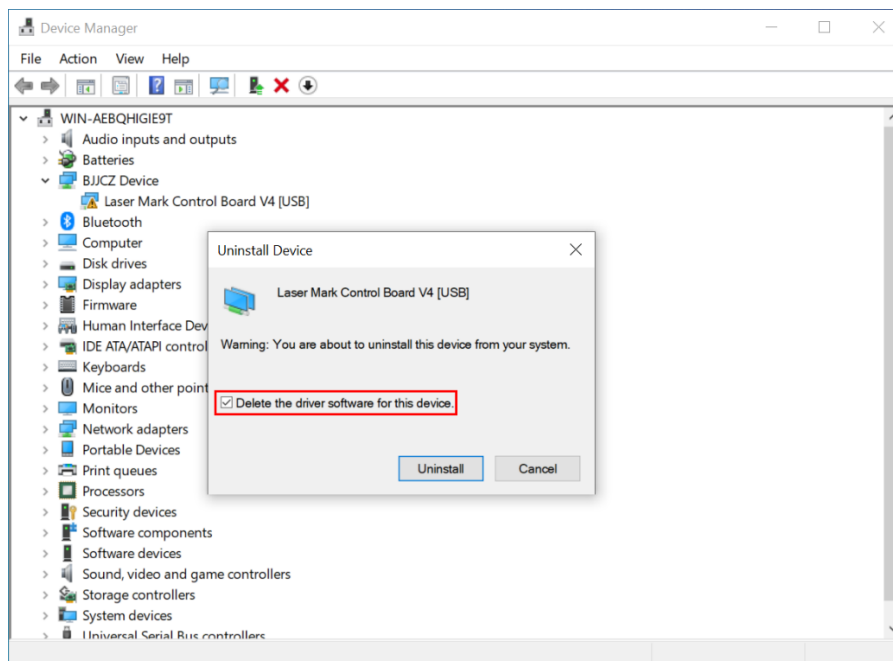

- After the device manager reloads, click the “Action” from menu and choose “Scan for hardware changes”.
- Uninstall is complete, you can try to reinstall the new driver.

### EZCAD2 Installation

## Cloudray Laser System

- Copy EZCad2 folder to PC's hard disc.

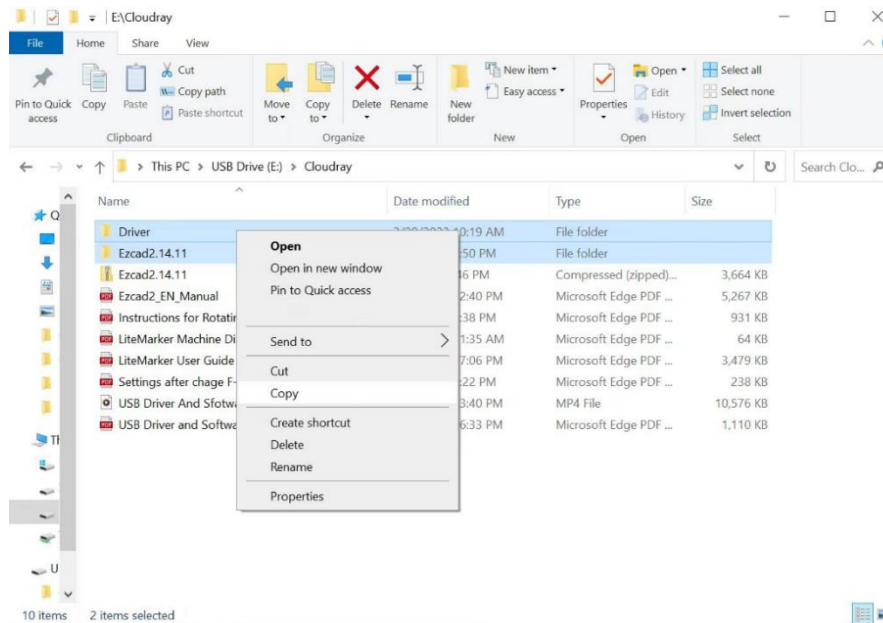

- Double click the EZCad2.exe to open EZCAD2.

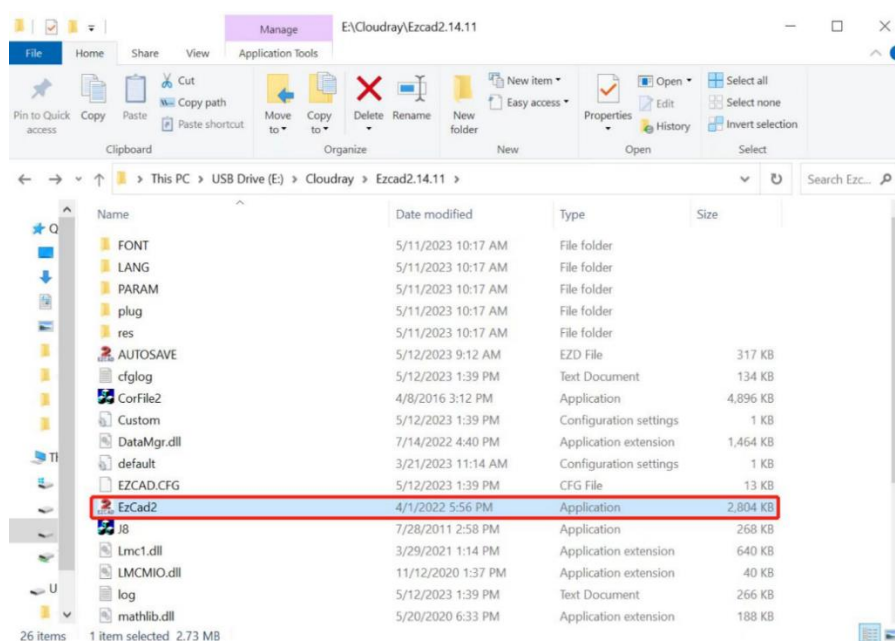

Important: If user run the software without connect the fiber laser, a caution will appear, and the software will work at demo state. In demo state, we can evaluate the software, but we cannot save files and cannot control laser device.



Important: The Software, Drive, Manual and Correction files are in the U-disk coming with the fiber machine.

## 6.3. EZCAD main interface view

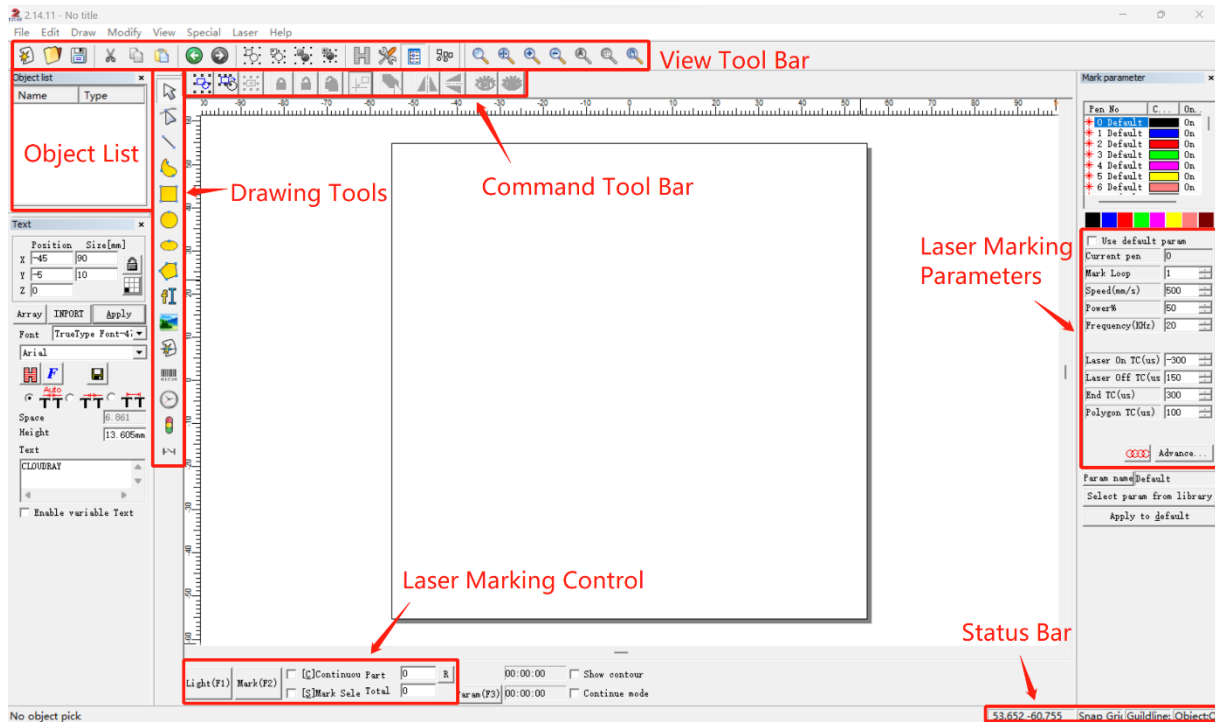

Cloudray LiteMarker marking machine is controlled by the included EZCad2 software, which must be installed on a compatible computer to direct the laser. See its separate instruction for full details on its components and use. Some features which are particularly important to note include the following parameters and controls:

### 6.3.1. Marking parameter

- **Loop Count / Mark Loop**—Specifies how many times the laser beam will repeat its path, creating greater contrast in the marked image.
- **Speed**—Specifies the speed of the beam in millimeters per second, with greater speed creating less contrast in the marked image.
- **Power**—Specifies the % of the machine's rated power that will be used, with greater power creating greater contrast. Note again that running the machine at greater than 80% power will shorten its service life and 10–75% is recommended for most applications.
- **Frequency**—Specifies the laser's frequency in kilohertz (kHz), with higher frequency producing a denser laser mark and darker engraving. (For 20&30W Q-pulse fiber laser, the adjustment range is 30-60kHz; for 50W Q-pulse fiber laser, the adjustment range is 50-100kHz)

### 6.3.2. Laser Marking Control Bar

- **Red/Light (F1)**—This item is used to mark the frame of the object without laser output so that users are convenient to orient the workpiece. This function is available in those laser machines which have guide light.
- **Mark (F2)**—Fires the laser beam and focus improvement.
- **Continuous:** mark the objects recently until user stop the mark.
- **Mark Selected:** only those selected objects would be marked.
- **Part:** the total counts that the mark command has been executed.
- **Total:** The total counts that the mark command should be executed. The value would decrease 1 automatically after the mark command has been executed each time. It is unavailable under the mode of Continuous Marking. When in marking process, if the amount number is more than 1, the marking operation will not stop until the marking number is 0.
- **Parameter:** machine parameter.

### 6.4. Focusing



It is essential to maintain the correct focal distance for every laser marking process. Only when in focus will the laser beam achieve the power density necessary for permanent and clearly legible marking.

Prior to any marking it is therefore necessary to set the correct focal distance between the marking head and the workpiece. An incorrect focal distance is the most common cause of poor or even indistinguishable markings.

The focal distance (A) is measured between the lower edge of the galvo head (B) and the upper surface of the workpiece (C). The correct focal distance depends on the F-theta lens used (focal length).

Note: The data is for reference only and subject to actual usage!

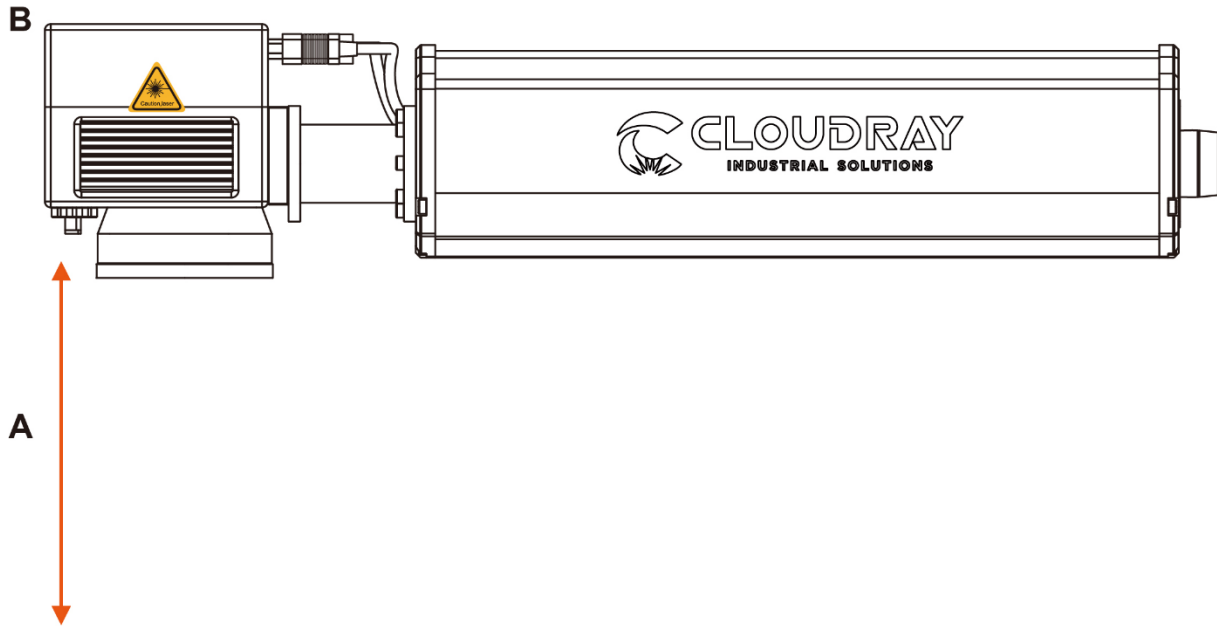

C

Lens	Scan Field(mm)	Focal distance (A)
F100	70x70	152
F160	110x110	215
F290	200x200	360
F420	300x300	494



Use the manual Z-Axis handle or the up and down buttons on the Keypad to move the head in the correct position.

## 6.5. Rotary attachment (option)



Damage to electronics.  
 Inserting or removing the Rotary attachment while the machine is turned on may irreparably damage the electronics. Switch off the machine before inserting or removing the Rotary attachment.

### 6.5.1. Mounting the work piece in the rotary attachment

1. Put the rotary axis attachment onto the working table.
2. Connect the rotary axis attachment via the control cable with the 4-Pin plug connector of the motion system.
3. Before you mount the object into the rotary axis attachment, measure the diameter of the object at the position to be engraved with a sliding caliper or a similar tool. Record the value (e.g., 50mm).
4. Fix the slider to make the work piece fitting into the rotary axis attachment.
5. Position the galvo head over the workpiece at the position where you want to mark.
6. Use the manual Z-Axis handle to move the head in the correct position (upper surface at focal length position).

### 6.5.2. Text rotate marking

1. Create a new text, click the “Draw Test” button on the drawing tools bar.
  - a) Enter the text in the Test box.
  - b) Modify the text size and font.
  - c) Press the apply button for the changes to take effect. (Set the text according to the marking requirements)

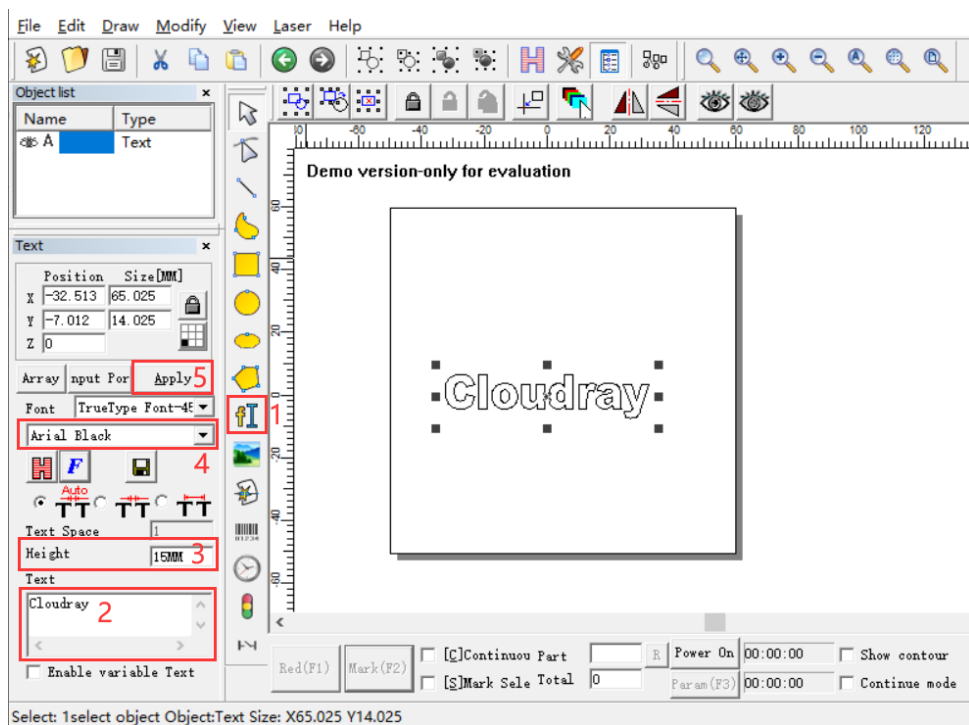



2. Adjust the text direction as required.

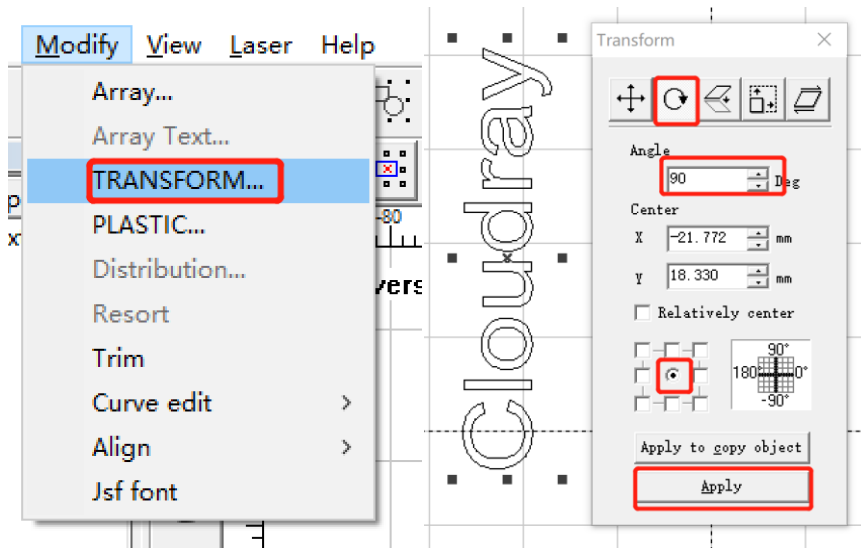

3. Press “Put to origin” button to place the text in the center of the processing area.

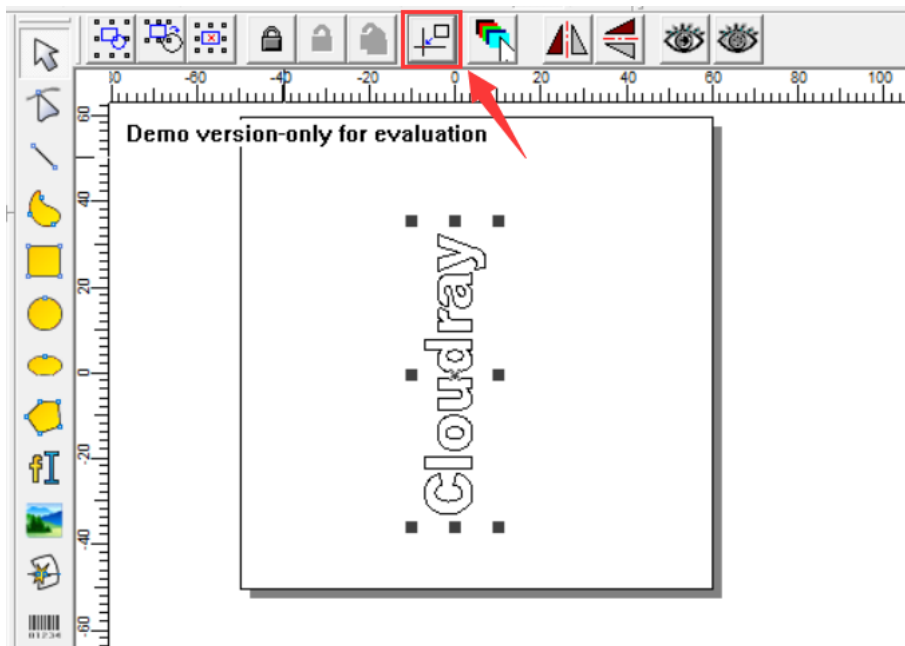

4. Press “Hatch” button to fill in the text.

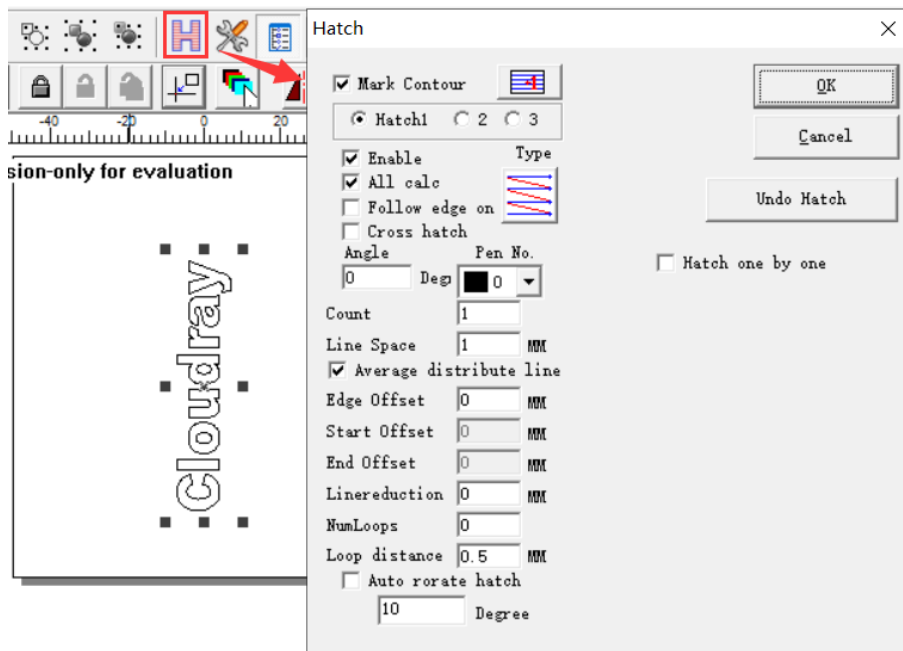

5. Menu bar—Laser—Rotate Text Mark—Set parameters

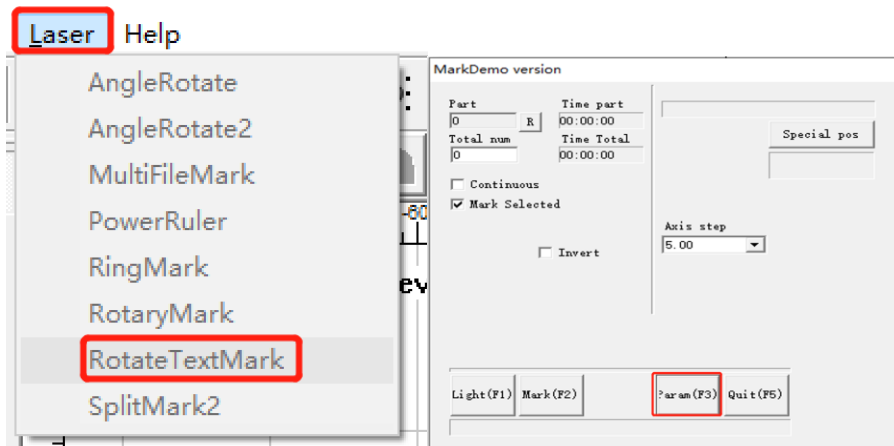

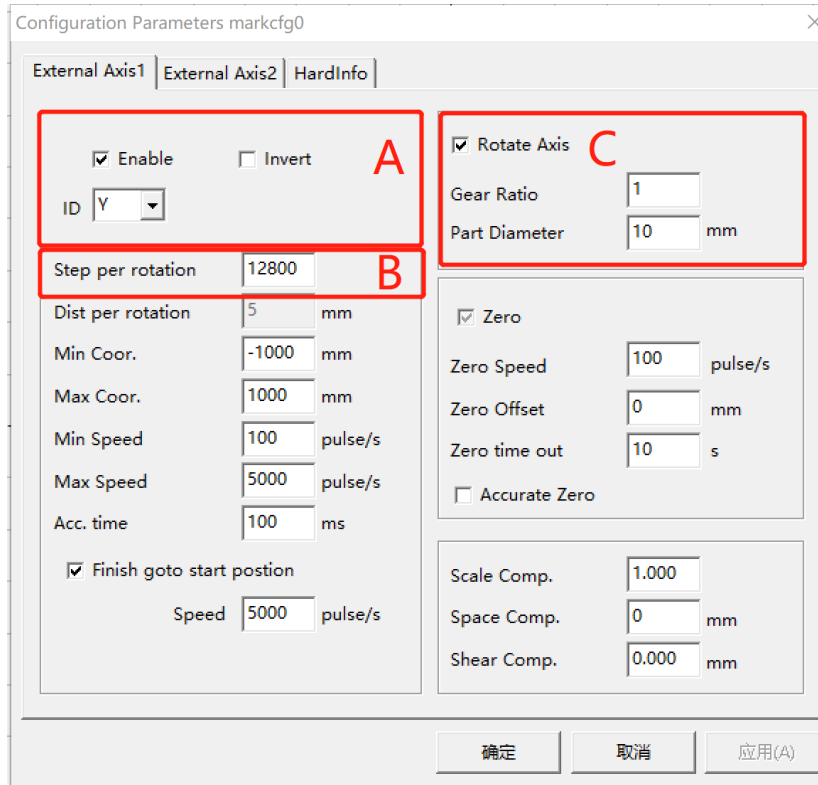

A. Enable extended axis, reverse mode, enable Y axis (enable X or Y axis according to the direction in which the rotation axis is placed).

B. The value of the number of pulses per revolution is the subdivision value on the drive, and the number of pulses usually used is 12800 or 25600.

C. Enable the function of the rotary, the gear ratio value is determined according to the reduction ratio of the rotating axis, the workpiece diameter is the actual diameter of the workpiece to be processed.

6. Enter the diameter of the workpiece to mark.

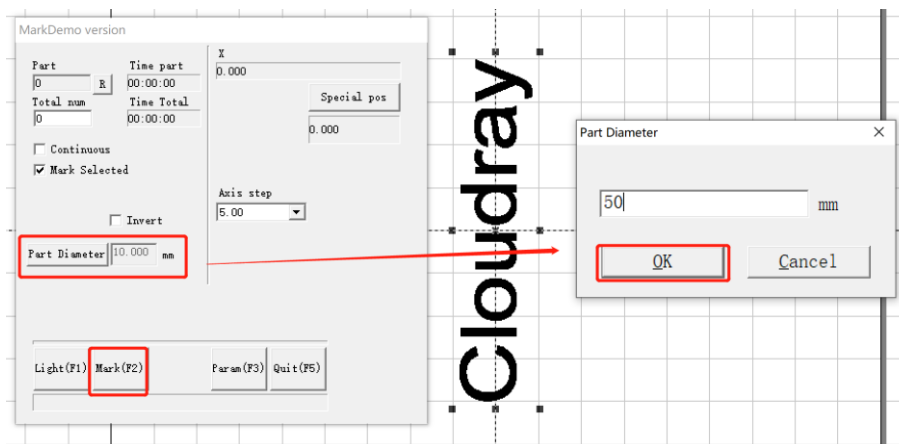

7. Press Mark(F2), the fiber laser will mark your image.

### 6.5.3. Vector file rotate marking

1. Import vector files, modify text size and parameters, and fill files

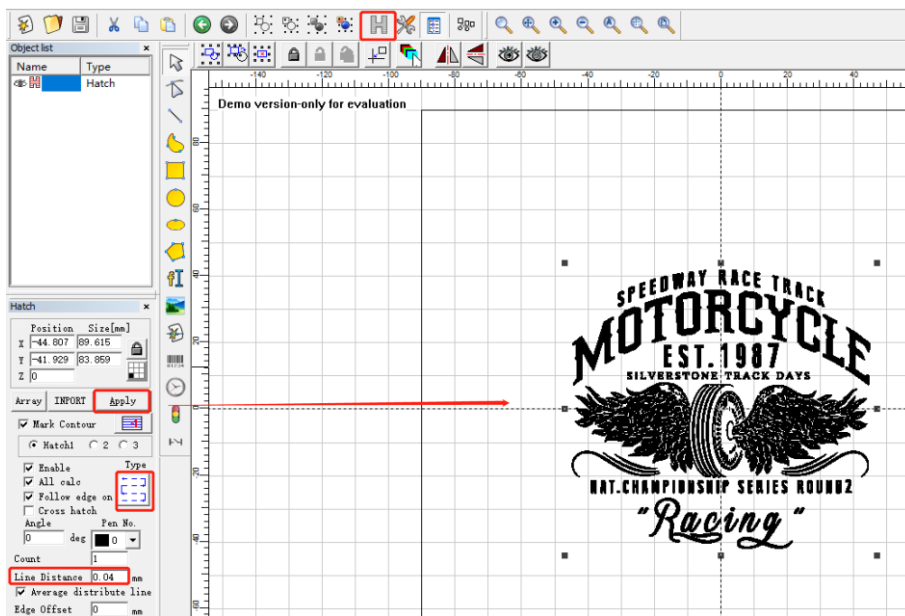
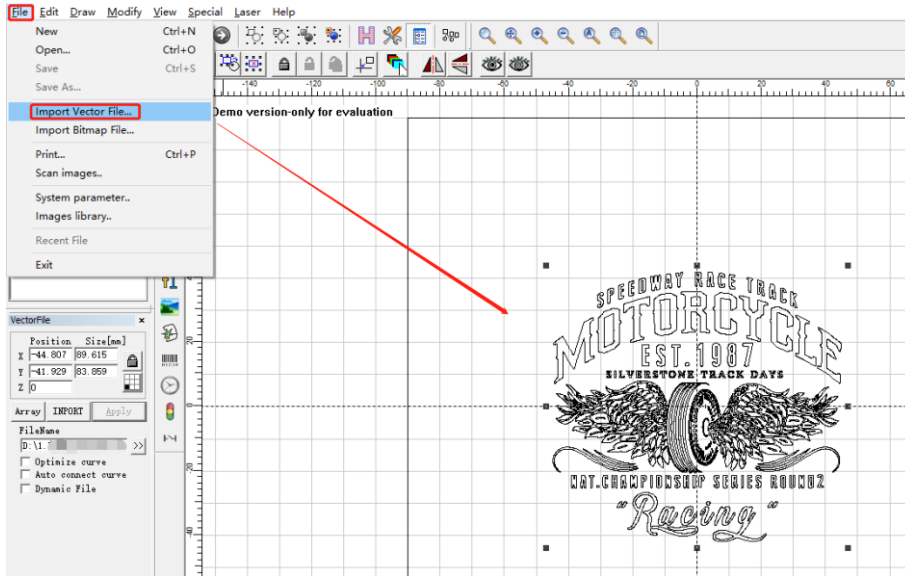

2. Menu bar—Laser—Split Mark2—Set Parameters

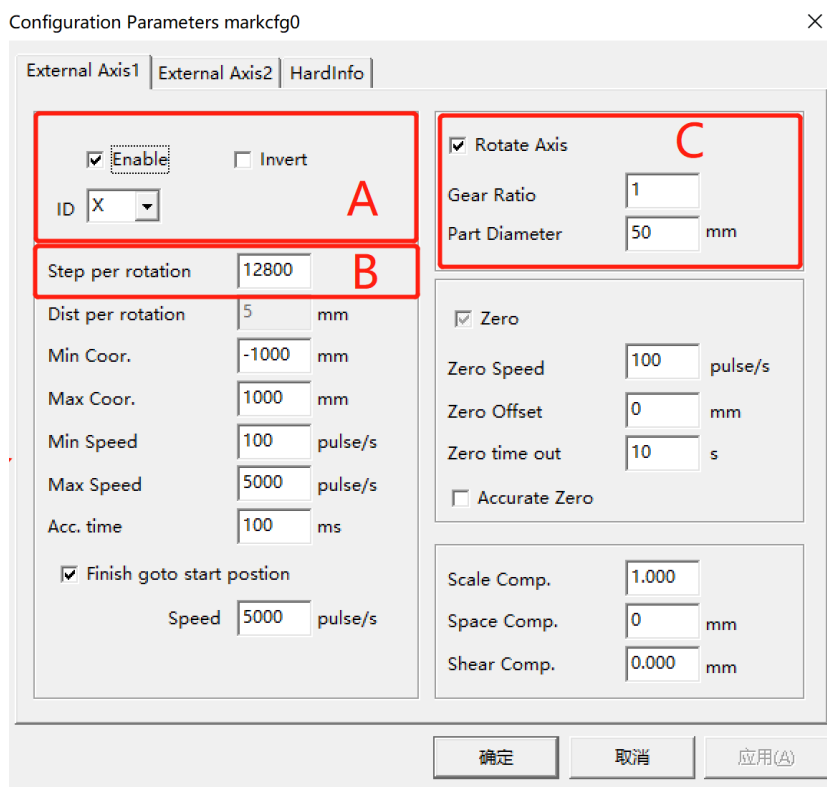
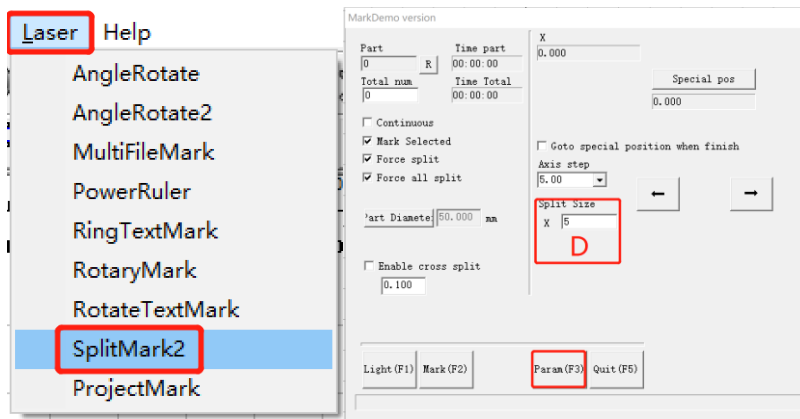

A. Enable extended axis, reverse mode, enable Y axis (enable X or Y axis according to the direction in which the rotation axis is placed).

B. The value of the number of pulses per revolution is the subdivision value on the drive, and the number of pulses usually used is 12800 or 25600.

C. Enable the function of the rotary, the gear ratio value is determined according to the reduction ratio of the rotating axis, the workpiece diameter is the actual diameter of the workpiece to be processed.

D. The smaller the split size, the better the engraving effect. Usually, the split size is 1~5mm.

3. Enter the diameter of the workpiece to mark.

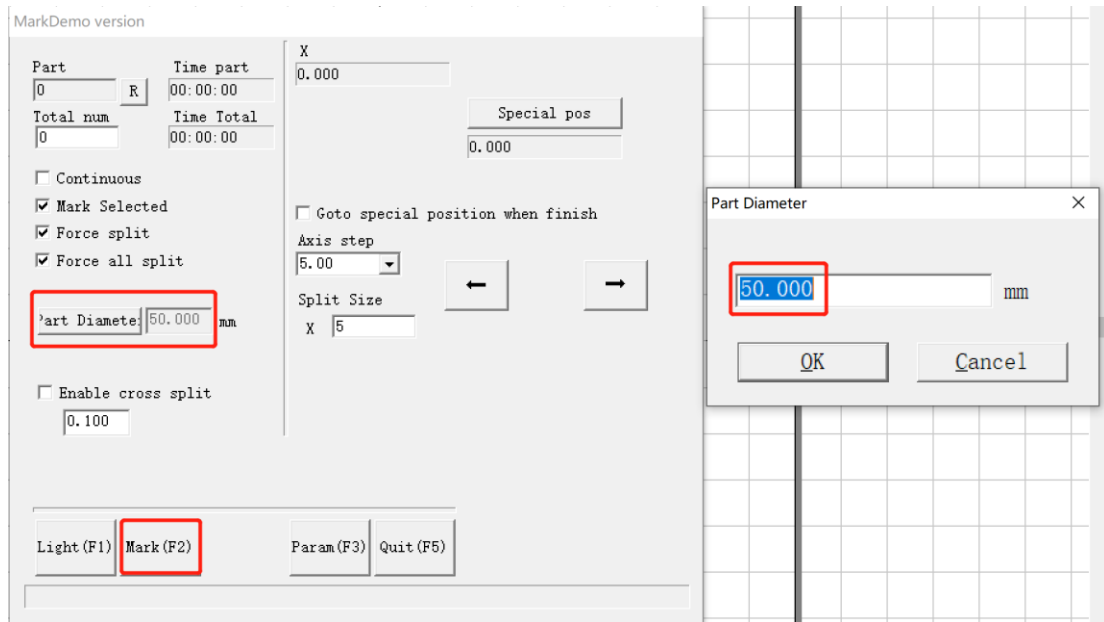

4. Press Mark(F2), the fiber laser will mark your image.

## 7. 1st Marking Job



Operate this laser marking machine only in accordance with all the instructions provided in this manual. Failure to follow the proper guidelines detailed here can result in property damage and personal injury.

To be safe, never ever run the laser system unattended.

This section will address only some of the options and features provided by the operation software. Before beginning to use the machine, make sure that you have read this entire manual (particularly the Safety Information above), the separate software manual, and all warnings provided on the machine itself.



**Step 1.** Put on your protective eyewear. Ensure that anyone else who might be exposed to direct or reflected laser beams is also wearing protective eyewear.

**Step 2.** Turn on the laser marker by following these steps:

1. Rotate in the direction of the arrow and pop out the emergency stop button.
2. Press the controller switch.
3. Press the laser switch.



Turning the laser key and pressing the buttons out of order may cause electrical hazards as the separate power supplies are grounded in order. Do not activate everything quickly. Give each power supply time to come online, activating its fans. 3 seconds is sufficient.



To reduce the risk of electric shock, once the engraver is on, try to touch its components with only one hand at a time.

**Step 3.** If you previously disconnected the control computer, reconnect it via the USB cable now. If your computer is already connected and EZCad2 is already running, restart it now to establish a connection between the computer and the laser's control board.

**Step 4.** Load or create a design in EZCad2.

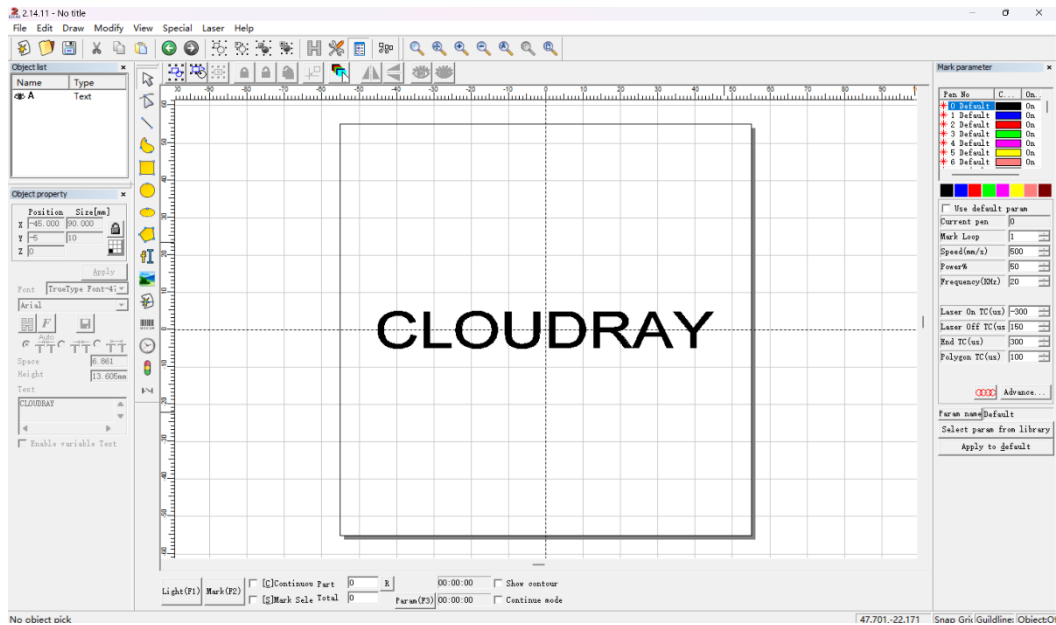

This software supports these file types:  
 Common types of images are supported. (bmp, jpg, gif, tga, png, tif...)  
 Common vector images are supported. (ai, dxf, dst, plt...)

**Step 5.** Press Hatch button at command tool bar, choose Hatch1(or you can choose the other according to your need). Set the Line space as 0.05mm (Range of 0.01-0.1mm is recommended), then press “OK”.

**Step 6.** Customize your contrast and marking depth by adjusting the marking parameters in EZCad2.

To darken an image, use a higher frequency setting. To lighten it, use a lower one. To increase engraving depth, increase the amount of energy per unit area by reducing the speed parameter or increasing the laser's power or the number of loops. Marking too deep, however, reduces image quality, especially for coated materials. Again, constantly using power settings over 80% will shorten the expected service life of your laser.

Resolution should usually be set to 500 dots per inch. Reducing your image resolution can be helpful in some cases, reducing flaming and increasing the energy of the pulse in a way that improves the quality of the resultant image in some materials such as some plastics.



For 20W Q-pulse fiber laser, the range of Frequency is 20-60kHz.  
 For 30W Q-pulse fiber laser, the range of Frequency is 30-60kHz.  
 For 50W Q-pulse fiber laser, the range of Frequency is 50-100kHz.



**Step 7.** Activate the laser guidance system by pressing Red or hitting F1 in EZCad2. The design should be displayed in red light on the workbench, showing where the laser will fire.



**Step 8.** Place an expendable piece of the material to be engraved in the location shown by the laser guidance. Do not use a different target as the galvo lens automatically focuses on different heights for different materials. Being careful that no part of your body is near the workbench or laser path, press Mark or hit F2 in EZCad2 to fire the test laser. Alternatively, you can activate the laser by using the foot pad.



**Step 9.** The laser is invisible but will create a buzzing noise and sparks and begin engraving when it is correctly focused on your test material. If no sparks are emitted, the laser is out of focus. Continue to fire it while adjusting the up or down using its height adjustment knob. Small, consistent sparks will be emitted at the marking point when the beam is correctly in focus. Take a note of the correct height for future reference.

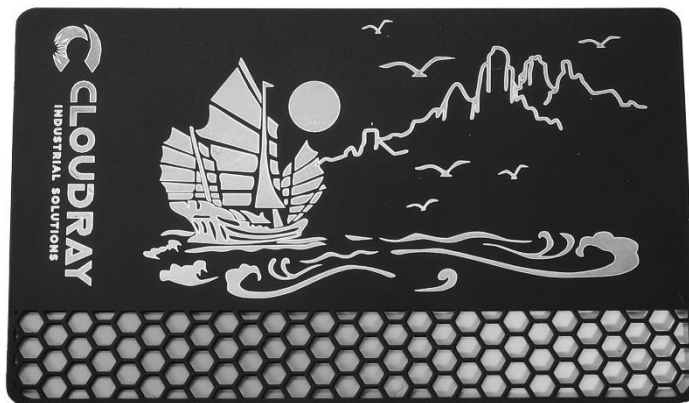

**Step 10.** Replace the test material with the actual material. Use the foot pad or press Mark or hit F2 in EZCad2 to engrave your pattern. Again, do not stare at the laser in operation even with protective eyewear. Watch for possible issues like sparks or fires, however, and be prepared to quickly extinguish a fire if necessary.

**Step 11.** Examine the quality of your first run and adjust the laser parameters in EZCad2 as necessary to create your desired effect. The foot pedal is particularly useful for continuous or repeated operation of the laser once you've settled on your design and its ideal parameter settings. You can also achieve more control of the marking process by reducing the laser's speed and using the foot pad.

**Step 12.** When you have finished engraving your design, close EZCad2 and then turn off the laser marking machine by following these steps:

1. Press the laser switch.
2. Press the controller switch.

3. Press the emergency switch.

**Step 13.** Cover the galvo lens and fully clean the workbench. For best results, disconnect your fiber marking machine from its power supply between uses. Unplug it or turn off its intermediary surge protector.

## 8. Instructions for Specific Materials

When engraving a new material, it can be helpful to engrave a test matrix of small boxes produced with various speed, power, and frequency settings to home in on the exact effect that you are looking for. To speed the process, here are some general guidelines for commonly engraved materials. Again, however, these are only guidelines for your convenience and it is the responsibility of the user to consult material safety data sheets and other sources to ensure the safety of working with various materials and setups. Some of the materials listed will require additional workspace and personal protective equipment in addition to this engraver:

### 8.1. Metals

When engraving metals, generally use high power, a low frequency, and low to medium speed settings. To avoid using your marker at greater than 80% power for extended periods, you can also get similar effects by reducing the power somewhat while also increasing the number of passes or decreasing the engraving speed. Be mindful that some metals will produce conducting, reflective, and/or toxic dust. Softer metals naturally produce more dust during engraving, while harder metals can require higher power settings that also produce more dust. In addition to the risk to the user's skin and eyes, there may be enough dust produced (especially for repetitive industrial applications) that a full ventilation system is required to address the problem. Similarly, operators and others in the work area may need to use breathing PPE such as masks and respirators.

**Aluminum:** Bare aluminum requires a somewhat higher frequency than other metals and will never produce a strong black mark similar to those created by engraving steel. When darker marking is required, consider employing anodization or producing a deep engraving that can be darkened by using black epoxy or other filler. Anodized aluminum requires a little more speed but a very low frequency.

**Powder Coated Metals:** Metals with a powder coating usually require a very high frequency and, for best results, at least 3 passes to remove the coating and polish the bare lower layer.

**Precious Metals:** Gold and similarly soft metals should be engraved with less power but a moderate speed. Silver and other semidurable metals are best engraved at a slightly higher power and slightly slower speed, but still not at the same power and speed as steel or aluminum.

### 8.2. Plastics

When engraving plastics, generally use low power and high speed settings. Marking and engraving with too much power or at too low a speed can concentrate too much energy at the point of contact, causing the plastic to melt. Among other problems, this may produce, poor engraving quality, noxious fumes and even fires.

## 8.3. Stone

When engraving various kinds of stone, generally use moderate power and speed at low frequency. As with ceramics and metals, be mindful of the dust created (especially for repetitive industrial applications) and take similar measures to ensure the safety of users and others in the work area.

## 9. Maintenance

### 9.1. Maintenance Overview



Unless otherwise specified, **ONLY** perform adjustment and maintenance of this device when the power is turned off and the power supply has been disconnected. **ONLY** allow trained and skilled professionals to modify or disassemble this device.

All maintenance work must be carried out according to the safety regulations.

### 9.2. Regular Maintenance Procedures

- Always keep the workroom clean and dust-free.
- Ensure the device is fully powered off when not in use.
- Cover the galvo lens when it is not in use.
- Clean the workbench after use with a cloth wetted with greater than 75% rubbing alcohol. **NEVER** clean this device with abrasive or caustic cleansers, with aerosol sprays, or with enough water to enter any electrical component. Always allow surfaces to fully dry before further use.
- If removing dust from the device's vents using a vacuum, **ONLY** use the lowest power setting to avoid damage to internal components.
- It is normal for a laser to experience a certain power decline after long-term use. It is recommended to use the equipment reasonably to protect the lifespan of the entire machine; At the same time, high reflective materials have a certain impact on the equipment, and attention should be paid to reasonable processing.



No other servicing should be done by the operator. Do not attempt to service or replace other parts yourself.

## 9.3. Cleaning the Lenses

This system is fitted with high quality optical components, which under normal operating conditions are maintenance free for their lifetime. However, it may be necessary to clean output lenses, e.g. the scanner flat field lens (f-theta lens) if it becomes covered in dust or fumes.



- Never touch the optical components with your fingers! Oily or dirty hands may damage the lens surfaces.
  - Do not use any tools or hard objects to clean the surfaces. Scratches cannot be repaired.
- Never touch the lens surfaces.
  - Do not use any tools or hard objects to clean the surfaces. Scratches cannot be repaired.
  - Laser optics are highly sensitive and their surfaces are not as hard as traditional glass.
  - They can also be easily damaged by cleaning. It is therefore necessary to ensure that any dirt is removed using a suitable suction device and that the surrounding area is cleaned regularly.
  - Do not use compressed air as it contains small quantities of oil and water.
  - To remove larger pieces of dirt, only use a lens cleaning cloth with high proof (min. 98 %) alcohol.
  - Do not dip the cleaning cloth in the cleaning solution. This contaminates the solution and makes it unusable. Place drops of the solution on the cloth!
  - Apply the cleaning solution carefully in order to avoid scratching the surface of the lens.
  - Do not wipe the lens with a dry cloth. Do not touch the reverse side of the cloth. Dirt and sebum on the fingers can be transferred to the lens by the cloth and cause damage.
  - Distribute the cleaning fluid carefully using small circular motions. Start at the center of the lens and move outwards to the edge. Keep moving the cloth until the entire surface is clean.
  - Do not exert any pressure on the lens.

## 9.4. Troubleshooting Guidance

Potential Problems	Possible Solutions
No Laser Output	Correct the focus by adjusting the height of the laser arm.
	Correct the software parameters if they are invalid or mistaken.
	Have a technician fix or establish the connection between the laser and the mainboard.
	Have a technician fix or establish the connection between the laser and its power supply.
	If either the fiber laser source or its power supply have worn out, have a technician replace them.
No Engraving despite Laser Output	Confirm that the material can be safely engraved with this device.
	Correct the focus by adjusting the height of the laser arm.
	Adjust the software parameters to create greater intensity.
	Have a technician check the control panel, scanning lens, and its power supply. Correct any problems or replace the part.
Other Laser Errors	Have a technician check the fiber laser source and the mainboard. Correct any problems or replace the part.