



## 广州特域机电有限公司

地址：广州市番禺区钟村镇钟创路50号

GUANGZHOU TEYU ELECTROMECHANICAL CO., LTD.

Address: No.50, Zhongchuang Road, Zhongcun town, Panyu District, Guangzhou, China.

Post Code: 511495 Email: marketing@teyu.com.cn

Tel: +86-20-89301885 89301886 Fax: +86-20-84309967

全国服务热线: 400-600-2093 www.teyu.com.cn



特域冷水机微信服务平台  
TEYU CHILLER SERVICE WECHAT ID

CW-5000|5200 SERIES



# CW-5000 | 5200

SERIES

## Industrial Chiller USER MANUAL

## 工业冷水机使用安装说明



## 目录

使用注意事项	1
外形及部件名称	2
安装说明	3
运行状况与参数调整	4
温控操作案例	10
流量报警与输出端口	12
技术参数	13
简单故障处理	14
装箱清单	14

感谢您购买广州特域机电有限公司的产品，请在使用前仔细阅读使用安装说明书，并妥善保管。

本使用安装说明书并非质量保证书，对印刷错误的更正，所述信息的修改，以及产品的改进，均由广州特域机电有限公司随时做出解释，恕不预先通知，修正内容将编入再版使用安装说明书中。

## 使用注意事项

### 1 请确保电源插座接触良好并且地线可靠接地！

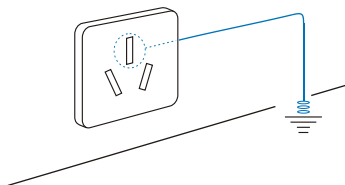

### 2 请确保冷水机的工作电压稳定、正常！

由于制冷压缩机对电源电压比较敏感，我公司标准产品的正常工作电压为200-250V(110V机型为100-130V)。如果确实需要更宽的工作电压范围，可以另行定制。

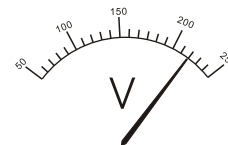

### 3 电源频率不匹配会导致机器损坏！

请根据实际情况，使用50Hz或60Hz的机型。

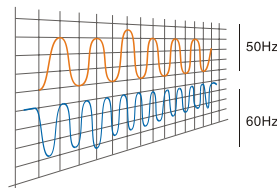

### 4 为保护循环水泵，严禁无水运行！

新机装箱前都排空了储水箱，请确保水箱注入足够水后再开机，否则水泵极易损坏。当水箱水位在水位计绿色(NORMAL)范围以下时，冷却机制冷量会轻微下降，请保证水箱水位在水位计的绿色(NORMAL)范围内。严禁使用循环泵排水！



### 5 请确保冷水机入风、出风通道顺畅！

冷水机上面的出风口距离障碍物要留有50cm以上的距离，侧面的入风口离障碍物要求距离在30cm以上。

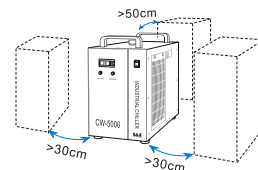

### 6 入风口的滤网必须定期清洗！

必须定期拆洗防尘网，防尘网严重堵塞会引起冷水机故障。

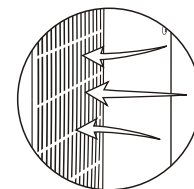

### 7 请注意冷凝水的影响！

当水温低于环境温度，并且环境湿度较大时，循环水管与被冷却器件表面会产生冷凝水。当出现以上情况时，建议调高水温或对水管与被冷却器件进行保温。

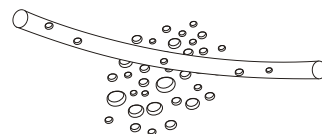

### 注意：



本产品为工业设备  
请勿让非专业人士操作！

# 外形及部件名称

## 机身正面

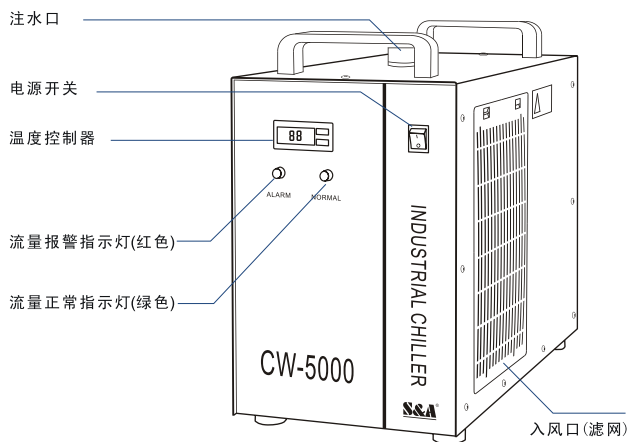

## 机身背面

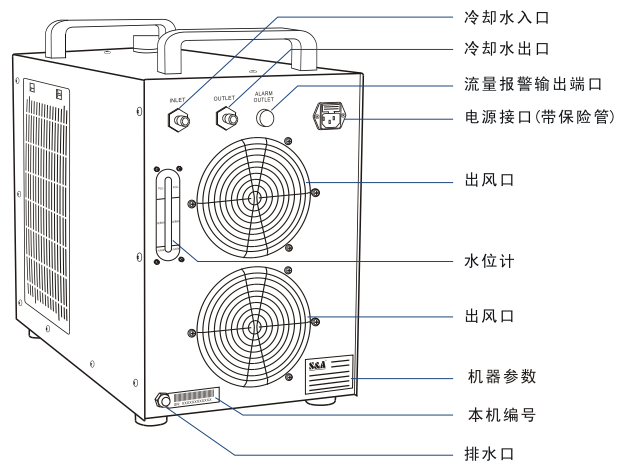

# 安装说明

工业冷水机安装使用非常简易  
新机首次使用可以按以下步骤进行:

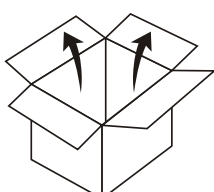
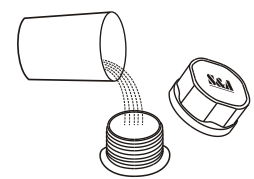
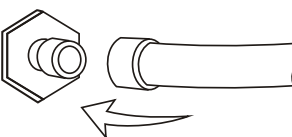
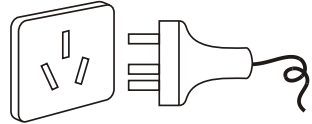
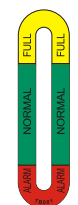
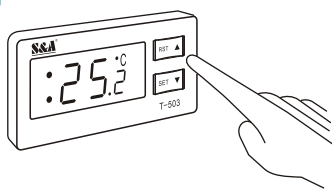
<p><b>1</b></p>  <p>打开包装，检查机器是否完好，附件是否齐备</p>	<p><b>2</b></p>  <p>拧开机器注水口加入冷却水 (注意不要让水溢出)</p> <p>加水时应同时观察水位计的水位慢慢加水，注意不要让水溢出！用于碳钢材质设备的冷却时应添加适量的冷却水添加剂（防腐蚀性剂）。寒冷地区使用的应该加注无腐蚀性的防冻液。</p>
<p><b>3</b></p>  <p>根据设备情况接好 出水管、入水管</p>	<p><b>4</b></p>  <p>插上电源线，打开电源开关 (严禁无水开机)</p> <p>(1) 打开电源开关后，冷水机循环泵就开始工作了。新机第一次开机时管路中会有较多的气泡导致机器偶尔流量报警，运行数分钟后就会恢复正常。 (2) 第一次开机后，必须马上检查水管管路有无漏水。 (3) 打开电源后，如果水温低于设定温度，机器的风扇等器件不工作是正常现象。温控器会根据设定的控制参数自动控制压缩机、电磁阀、风扇等器件的工作状态。 (4) 由于压缩机等器件有一个较长的启动过程，根据不同的工况从几十秒到数分钟不等，所以不要频繁开关机。</p>
<p><b>5</b></p>  <p>水位过高 正常水位 超低水位</p> <p>检查水箱水位</p> <p>新机开机后排空了水管中的空气，水箱水位会略有下降，为了保持水位在绿色区域，可以再次适量加水。观察并记下当前的水位情况，等冷水机运行一段时间后再次观察水位计，如果水位下降明显，就要再次检查水管管路的渗漏情况。</p>	<p><b>6</b></p>  <p>调整温控器参数</p> <p>CW-5000/5200系列冷水机使用的智能温控器一般情况下不需要调整控制参数，如确实必要的，可参考第4页《运行状况与参数调整》。</p>

# 运行状况与参数调整

T-503新型智能控制器一般情况下不需要调整控制参数，它会根据室温的变化自动调整控制参数，保证满足设备的冷却要求。

T-504新型智能控制器出厂设定为恒温温控模式，水温设定为25度，用户可以根据需要调整。

T-503、T-504温控器除出厂设定参数不同外，其功能、结构是一样的。

## 1. 制冷控制器面板介绍

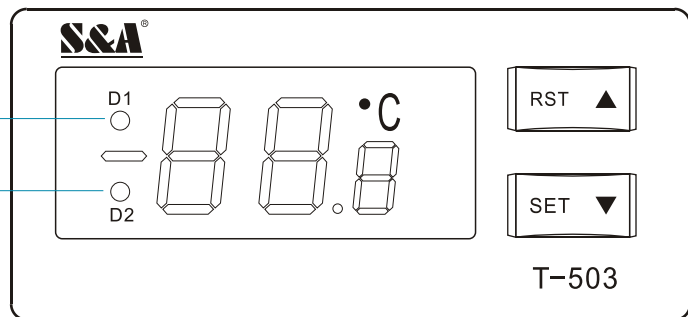

(1) 温控器工作状态指示灯D1、D2(如图)

**D1**

常亮，控制器工作在智能控制模式；  
不亮，控制器工作在恒温控制模式；  
闪亮，控制器工作在参数设定模式或显示数值为室温。

**D2**

常亮，冷水机工作在制冷状态；  
不亮，冷水机工作在保温状态；  
闪亮，冷水机工作在节能状态。

(2) ▲▼ 键 用于调整控制器显示状态，参数选择、调整。

(3) RST 键 确定按键。

(4) SET 键 设定功能按键。

## 2. 报警功能

(1) 报警显示：



报警时，出错的代码与水温会交替显示。

(2) 暂停报警声：

在报警状态下按任何键均可暂停报警声响，但报警显示需等到报警条件消除后才停止。

## 3. 温控器控制参数表

次序	代码	设定项目	范围	T-503 温控器 出厂设定	T-504 温控器 出厂设定	备注
1	F0	设定温度	F9~F8	25	25	恒温工作模式有效
2	F1	温差数值	-15~+5	-2	-2	智能控制方式有效
3	F2	制冷回差	0.1~3.0	0.8	0.3	
4	F3	控制方式	0~1	1	0	1智能、0恒温
5	F4	水温超高报警	1~20	10	10	
6	F5	水温超低报警	1~20	15	15	
7	F6	气温超高报警	40~50	45	45	
8	F7	密码	00~99	8	8	
9	F8	最高设定水温	F0~40	30	30	
10	F9	最低设定水温	1~F0	20	20	





#### 4. 恢复出厂设置

### 恢复出厂设置

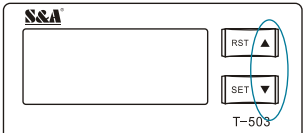
默认显示状态：

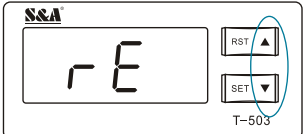
①  同时按下 ▲▼ 键不放然后开机

②  直到显示rE (才松开按键)

③  自动恢复显示实时水温

### 查看室内温度

默认显示状态：

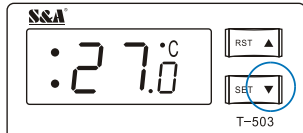
①  按 ▼ 键显示室温

②  此时D1闪动, 表明显示为室温  
6秒后恢复默认显示

③  自动恢复显示实时水温

#### 6. 一般设定调整

### 恒温模式下

默认显示状态：

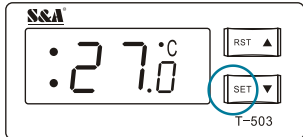
①  按SET键显示设定水温值(F0)

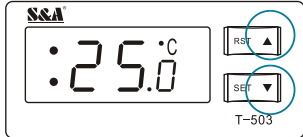
②  按 ▲ 或 ▼ 键修改设定温度值

③  按RST键保存退出参数返回温度显示  
(如20秒内无按键按下会自动退出设置, 不保存参数并返回温度显示)

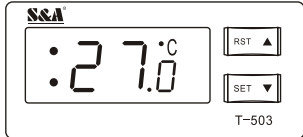

### 智能模式下

默认显示状态：

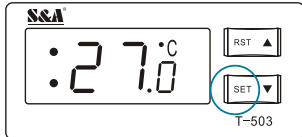
①  按SET键显示温差数值(F1)

②  按 ▲ 或 ▼ 键修改温差数值

③  按RST键保存退出参数返回温度显示  
(如20秒内无按键按下会自动退出设置, 不保存参数并返回温度显示)

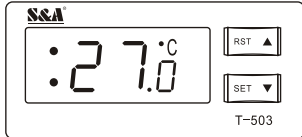

## 7. 高级设定调整

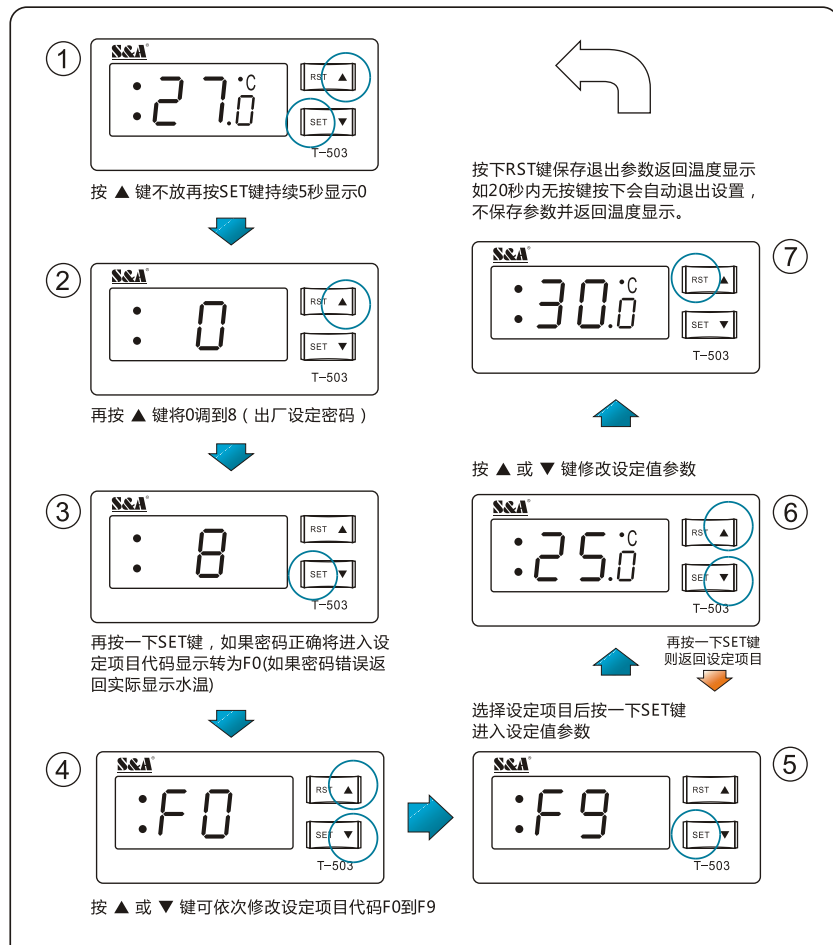

### 注：

- 1、在参数设定状态时, 系统按原参数运行;
- 2、恒温控制模式时, 水温由“F0”参数控制;
- 3、智能控制模式时, 水温会根据气温变化自动调整。其温差由“F1”参数控制。

## 8. 高级控制参数调整案例

次序	代码	设定项目	案例一 设定值	案例二 设定值	案例三 设定值	T-503 温控器 出厂设定	T-504 温控器 出厂设定
1	F0	设定温度		28	25	25	25
2	F1	温差数值	-3			-2	-2
3	F2	制冷回差	0.5	2.0	1.0	0.8	0.3
4	F3	控制方式	1	0	0	1	0
5	F4	水温超高报警	10	5	4	10	10
6	F5	水温超低报警	10	10	14	15	15
7	F6	气温超高报警	45	45	45	45	45
8	F7	密码	8	8	8	8	8
9	F8	最高设定水温	31	30	30	30	30
10	F9	最低设定水温	25	5	5	20	20

- (1) 案例一：智能温控模式控制冷却水温度。要求水温最高不超过31度，最低不低于25度，目标水温比气温低3度，在气温不变的情况下，水温波动不大于正负0.5度。当水温低于目标水温10度或者高于目标水温10度时报警。（即当气温在30.0度时，冷却水温在27.5度至26.5度之间，如气温变为30.5度，冷却水温在28.0度至27.0度之间）。
- (2) 案例二：恒温模式控制冷却水温度。要求冷却水温度恒定在28度、水温波动不大于正负2度。水温超过正常水温5度即超高温报警，低于正常水温10度时即超低温报警。并且可以方便的通过用户设定在5至30度之间调整水温设定。
- (3) 案例三：恒温模式控制冷却水温度。要求冷却水温度恒定在25度、水温波动不大于正负1度。水温超过30度即超高温报警，低于10度时，超低温报警。（即不管气温多少度，冷却水温恒定在24.0度至26.0度之间）。



# 流量报警与输出端口

为了保证在冷却水循环出现异常情况时不影响设备的安全，CW-5000/5200系列冷水机设有低流量报警保护功能。

## 1、流量报警输出端口及接线示意图

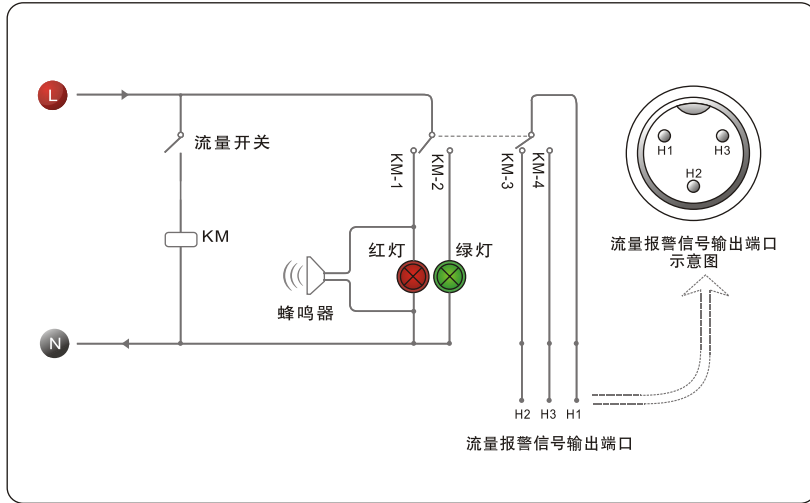

## 2、循环冷却水流量报警原因与工作状态表

系统指示 工作状态	流量正常 指示灯	流量报警 指示灯	蜂鸣器	输出端口 H1、H2	输出端口 H1、H3
循环泵工作正常	● 发光	⊗ 熄灭	⊗ 不发声	⊗ 断路	● 导通
冷却水循环回路堵塞	⊗ 熄灭	● 发光	⊙ 发声	● 导通	⊗ 断路
缺水报警	⊗ 熄灭	● 发光	⊙ 发声	● 导通	⊗ 断路
循环水泵故障	⊗ 熄灭	● 发光	⊙ 发声	● 导通	⊗ 断路
冷水机供电中断	⊗ 熄灭	⊗ 熄灭	⊗ 不发声	● 导通	⊗ 断路

注：流量报警端口连接机内继电器一组常开、常闭触点。要求工作电流小于5A，工作电压小于300V。

# 技术参数 CW-5000 参数表

型号	CW-5000AG	CW-5000BG	CW-5000DG	CW-5000AH	CW-5000BH	CW-5000DH	CW-5000AI	CW-5000BI	CW-5000DI
工作电压	AC 1P 220V 50Hz	AC 1P 220V 60Hz	AC 1P 110V 60Hz	AC 1P 220V 50Hz	AC 1P 220V 60Hz	AC 1P 110V 60Hz	AC 1P 220V 50Hz	AC 1P 220V 60Hz	AC 1P 110V 60Hz
工作电流	0.15~2.2A	0.15~2.3A	0.3~4A	0.25~2.3A	0.25~2.4A	0.45~4.15A	0.7~2.75A		1~4.7A
压缩机功率	0.295 KW 0.40HP	0.38KW 0.52HP	0.305KW 0.41HP	0.295 KW 0.40HP	0.38KW 0.52HP	0.305KW 0.41HP	0.295 KW 0.40HP	0.38KW 0.52HP	0.305KW 0.41HP
制冷量	2361Btu/h 0.692KW 595Kcal/h	2999Btu/h 0.879KW 756Kcal/h	2866Btu/h 0.84KW 722Kcal/h	2361Btu/h 0.692KW 595Kcal/h	2999Btu/h 0.879KW 756Kcal/h	2866Btu/h 0.84KW 722Kcal/h	2361Btu/h 0.692KW 595Kcal/h	2999Btu/h 0.879KW 756Kcal/h	2866Btu/h 0.84KW 722Kcal/h
制冷剂	R-134a								
充注量	300g	320g	280g	300g	320g	280g	300g	320g	280g
温控精度	±0.3℃								
节流器	毛细管								
安全保护	压缩机过流保护，流量报警，超温报警								
水泵功率	0.03KW			0.05KW			0.1KW		
水箱容量	6L								
出入口	外径10mm铜咀						直径10mm快速接头		
最大扬程	10M			12M			25M		
最大流量	10L/min			13L/min			16L/min		
净重	24Kgs								
毛重	27Kgs								
机器尺寸	58 X 29 X 47 cm (长 X 宽 X 高)								
包装尺寸	70 X 43 X 58 cm (长 X 宽 X 高)								

注：其它电源机型可以定制：有加热和更高温控精度的功能可供选择。

## CW-5200 参数表





型号	CW-5200AG	CW-5200BG	CW-5200DG	CW-5200TG	CW-5200AH	CW-5200BH	CW-5200DH	CW-5200AI	CW-5200BI	CW-5200DI
工作电压	AC 1P 220V 50Hz	AC 1P 220V 60Hz	AC 1P 110V 60Hz	AC 1P 220V 50/60 Hz	AC 1P 220V 50Hz	AC 1P 220V 60Hz	AC 1P 110V 60Hz	AC 1P 220V 50Hz	AC 1P 220V 60Hz	AC 1P 110V 60Hz
工作电流	0.15~3.8A	0.15~4A	0.3~5.55A	0.15~3.8A	0.25~3.9A	0.25~4.1A	0.45~5.7A	0.7~4.35A	0.7~4.55A	1~6.25A
压缩机功率	0.52KW 0.71HP	0.5KW 0.68HP	0.68KW 0.93HP	0.49/0.57KW 0.66/0.77HP	0.52KW 0.71HP	0.5KW 0.68HP	0.68KW 0.93HP	0.52KW 0.71HP	0.5KW 0.68HP	0.68KW 0.93HP
制冷量	5084Btu/h 1.49KW 1281Kcal/h	4982Btu/h 1.46KW 1256Kcal/h	5186Btu/h 1.52KW 1307Kcal/h	4825/5797Btu/h 1.41/1.70KW 1219/1465Kcal/h	5084Btu/h 1.49KW 1281Kcal/h	4982Btu/h 1.46KW 1256Kcal/h	5186Btu/h 1.52KW 1307Kcal/h	5084Btu/h 1.49KW 1281Kcal/h	4982Btu/h 1.46KW 1256Kcal/h	5186Btu/h 1.52KW 1307Kcal/h
制冷剂	R-22 / R-410a									
充注量	360g	380g	350g	360/380g	360g	380g	350g	360g	380g	350g
温控精度	±0.3℃									
节流器	毛细管									
安全保护	压缩机过流保护，流量报警，超温报警									
水泵功率	0.03KW			0.05KW			0.1KW			
水箱容量	6L									
出入口	外径10mm铜咀						直径10mm快速接头			
最大扬程	10M			12M			25M			
最大流量	10L/min			13L/min			16L/min			
净重	26Kgs									
毛重	29Kgs									
机器尺寸	58 X 29 X 47 cm (长 X 宽 X 高)									
包装尺寸	70 X 43 X 58 cm (长 X 宽 X 高)									

注：其它电源机型可以定制：有加热和更高温控精度的功能可供选择。

# 简单故障处理

故障现象	故障原因	处理方法
开机不通电	电源线接触不好	检查电源接口，电源线插头是否接插到位、接触良好
	保险管熔断	更换机器后面电源接口内保险管
流量报警(面板红灯亮)、用水管直接连接出水口、入水口没有水流	储水箱水位过低	检查水位计显示窗，加水到水位显示的绿色区域；并检查水循环管路有无漏水
连接设备使用时流量报警(面板红灯亮)、但用水管直接连接出水口、入水口时有水流，不报警	水循环管路有堵塞或水管折弯变形	检查水循环管路
水温超高报警(温控器面板显示E2)	防尘网堵塞，散热不良	定期拆下防尘网清洗
	出风口或入风口通风不良	保证出、入风口通风顺畅
	电压严重偏低或者不稳定	改善供电线路或使用稳压器
	温控器参数设置不当	重新设定控制参数或恢复出厂设置
	冷却机频繁开关机	保证冷水机有足够的制冷时间(五分钟以上)
	热负荷超标	降低热负荷，或选用更大制冷量的机型
室温超高报警(温控器面板显示E1)	冷水机使用环境温度偏高	改善通风，保证冷水机运行环境在40度以下
冷凝水凝结现象严重	水温低于环境温度较多，湿度大	调高水温或给管路保温
换水时排水口排水缓慢	注水口没有打开	打开注水口

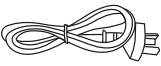
# 装箱清单

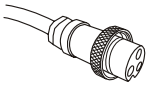
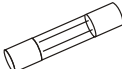
1 工业循环冷水机一台 	2 使用说明书一份 	3 电源线一条 	4 连接软管一条 
5 密封箍两个(选配) 	6 报警信号输出端插头一个 	7 备用保险管一个 (装在电源接口备用保险管座内) 	

# Contents

Cautions	16
Contour and parts introduction	17
Installation	18
Operation and parameters adjustment	19
Temperature controller operation cases	25
Flow alarm and output ports	27
Specifications	28
Simple troubleshooting	29
Packing list	29

Thank you for using the machine from  
GUANGZHOU TEYU ELECTROMECHANICAL CO., LTD.  
Please read the installation instructions carefully before  
installing and operating and keep it properly.  
This installation instructions is not a quality assurance.  
GUANGZHOU TEYU ELECTROMECHANICAL CO.,LTD.  
Reserves the right to the interpretation of correction of  
typographical errors, improper mentioned  
information and product improvement.  
The amended content will be reprinted in installation  
instructions without notice in advance.

# CAUTIONS

**1** Please ensure that the power supply and electrical outlet are in good contact and the earth wire must be firmly grounded!

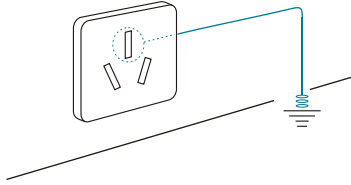

**2** Please make sure there is stable and normal voltage for the working chiller!

As the refrigeration compressor is more sensitive to the power supply and voltage, so the operating voltage of our standard product is of 200 ~ 250V (110V model is of 100 ~ 130V). If you do need a wider operating voltage range, customization is available for us.

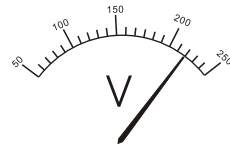

**3** Unmatched power frequency can cause the chiller damage!

Please choose model of 50Hz or 60Hz according to actual circumstance.

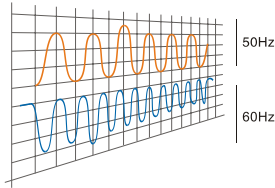

**4** To protect the pump, it's strictly forbidden to run the chiller without water in the storage water tank!

The new machine is packed after draining whole water in the tank, so please make sure the tank has water inside before machine starting, otherwise it's easily to have the pump damaged. When the water level is below the green (NORMAL) range of the water level gauge, the cooling capacity of our chiller will go down slightly. Hence please ensure the water level is within the green (NORMAL) range. To drain through circulating pump is strictly prohibited!



**5** Please be sure that the air inlet and air outlet are in good ventilation!

There must be at least 50cm from obstructions to the air outlet which is in the back of the chiller, and should leave at least 30cm between obstructions and the side air inlet.

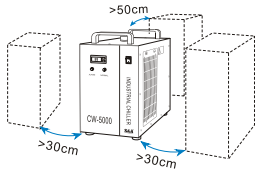

**6** The filter screen must be regularly cleaned!

It's essential to unpick and wash the dust gauge, or the serious blockage will cause breakdown to the chiller.

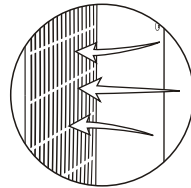

**7** Please pay attention to the effect of the condensate water!

With greater ambient humidity, when the water temperature is lower than the ambient temperature, the condensate water will generate on the surface of water circular pipes and the cooled components. If above circumstance appears, it is recommended to set a higher water temperature or keep pipes and cooled parts warm.

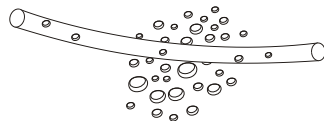

**PROFESSIONAL USE ONLY!**



The appliance is not to be used by children or persons with reduced physical, sensory or mental capabilities, or lack of experience and knowledge, unless they have been given supervision or instruction, children being supervised not to play with the appliance!

# CONTOUR AND PARTS INTRODUCTION

Front

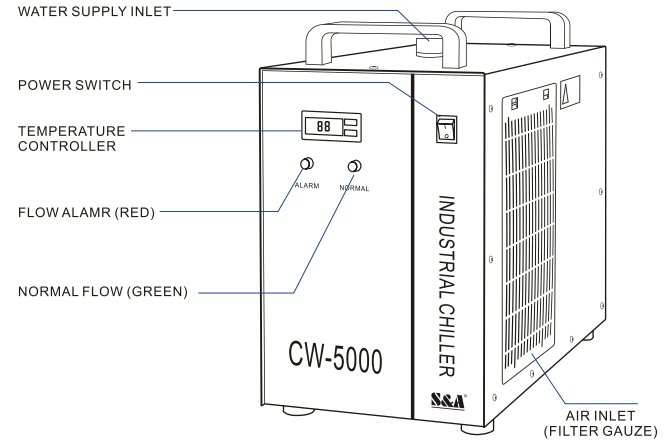

Back

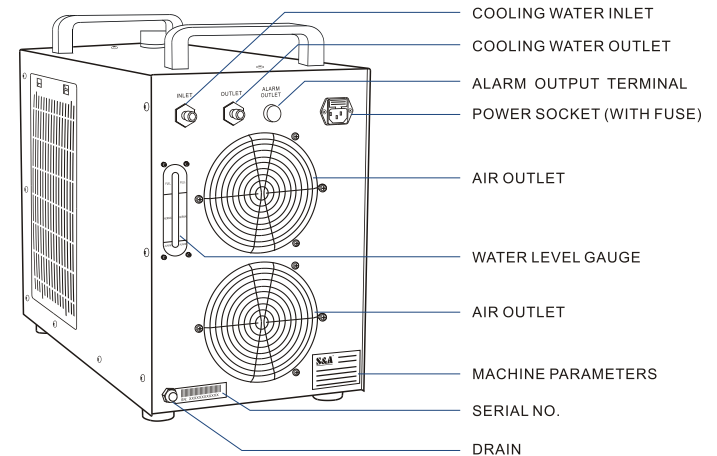

# INSTALLATION

It is very simple to install this industrial cooling machine. The installation for the first time of the new machine can be carried out by following steps:

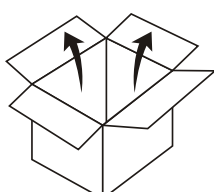
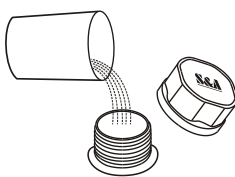
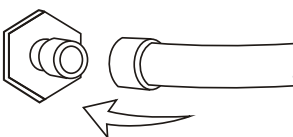
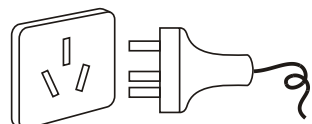
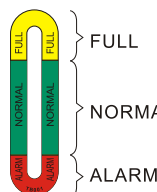
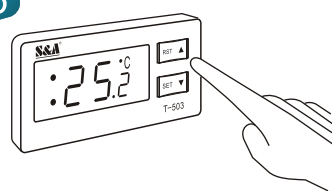
<p><b>1</b></p>  <p>Open the package to check if the machine is intact and all the necessary accessories are completed.</p>	<p><b>2</b></p>  <p>Open the injection port to feed cooling water. (Do not spill out the water!)</p> <p>Observing the water level gauge and adding water slowly, be careful not to have the water overflowed! For the cooling of carbon steel equipment, the water should be added an appropriate amount of cooling water additive (anti-corrosion water aqua). Users in cold area should use noncorrosive antifreeze fluid.</p>
<p><b>3</b></p>  <p>Connect the water inlet and outlet pipes well according to system conditions.</p>	<p><b>4</b></p>  <p>Plug in power and turn on the power switch. (Do not start up without water in the water tank!)</p> <p>(1) Power switch turned on, the circulation pump of the chiller starts working. The first time of operating may cause more bubbles in the pipe leading to a flow alarming occasionally, but running for a few minutes later, it will go back to normal.          (2) After the first boot, you must immediately check whether the water pipe leaks.          (3) Power switched on, if the water temperature is below the set value, it is normal that fans and other components of the machine do not work. The temperature controller will automatically control the working conditions of the compressor, magnetic valve, fans and other parts based on the set controlling parameters.          (4) As it takes a longer time to start over the compressor and other components, according to different conditions, the time is range from seconds to minutes, so do not turn off the power and again on frequently.</p>
<p><b>5</b></p>  <p>Check the water level in the water tank.</p> <p>The first startup of the new chiller empties the air in the water pipe, leading a slight water level decline, but in order to keep the water level in the green area, it's allowed to add adequate water again. Please observe and record the current water level, and inspect it again after the chiller running for a period of time, if the water level drops obviously, please re-inspect the water pipeline leakage.</p>	<p><b>6</b></p>  <p>Adjust parameters of temperature controller.</p> <p>CW-5000/5200 series use an intelligent thermostat. Normally users do not need to adjust it. If it is really necessary, please refer to page 19, "Operating status and parameters adjustment".</p>

# OPERATION STATUS AND PARAMETERS ADJUSTMENT

The new T-503 intelligent temperature controller does not need to adjust the controlling parameters under normal circumstance. It will self-adjust controlling parameters according to room temperature for meeting equipment cooling requirements.

The new T-504 intelligent temperature controller is selected constant temperature control mode as factory setting with water temperature at 25°C. User can adjust it as needed.

T-503 and T-504 controllers are of same functions and structure except factory parameters setting.

## 1. Temperature control panel description

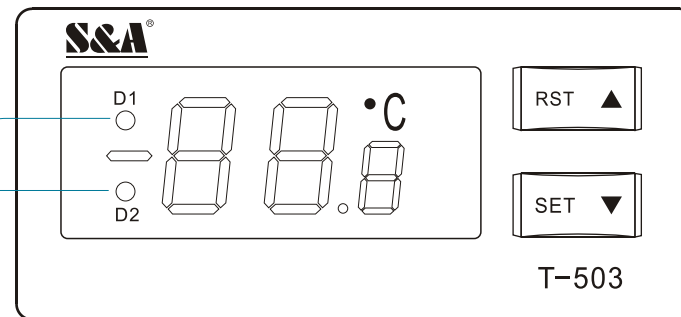

(1) Indicators D1, D2 (as shown) of thermostat working state

**D1**

ON: thermostat works in intelligent control mode;  
 OFF: thermostat works in temperature control mode;  
 FLASHES: thermostat works in parameters setting mode or displays value of room temperature.

**D2**

ON: chiller works in refrigerating state;  
 OFF: chiller works in the insulation working state;  
 FLASHES: chiller works in the energy-saving state.

- (2) ▲▼ buttons are for adjusting the display status of the controller, Parameters selection and adjustment.  
 (3) **RST** button: enter button.  
 (4) **SET** button: function setting button.



## 2. Alarm function

(1) Alarm Display:

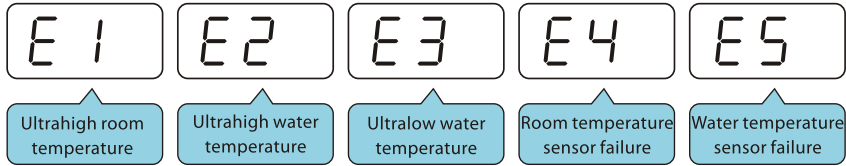

When alarm occurs, the error code and the temperature will be alternately displayed.

(2) To suspend the alarm:

In alarming state, the alarm sound could be suspended by pressing any button, but the alarm display remains until the alarm condition is eliminated.

## 3. Thermostat parameters list

Order	Code	Item	Range	T-503 Temperature controller Factory Setting	T-504 Temperature controller Factory Setting	Notes
1	F0	Temperature setting	F9~F8	25	25	Constant temperature control effecting
2	F1	Temperature difference values	-15~+5	-2	-2	Intelligent control effecting
3	F2	Cooling hysteresis	0.1~3.0	0.8	0.3	
4	F3	Way of control	0~1	1	0	1: intelligent 0: constant temperature
5	F4	Alarm for Ultrahigh water temperature	1~20	10	10	
6	F5	Alarm for Ultralow water temperature	1~20	15	15	
7	F6	Alarm for Ultrahigh room temperature	40~50	45	45	
8	F7	Password	00~99	8	8	
9	F8	The allowed highest water temperature	F0~40	30	30	
10	F9	The allowed lowest water temperature	1~F0	20	20	

## 4. Restore to factory setting

Restore to factory setting

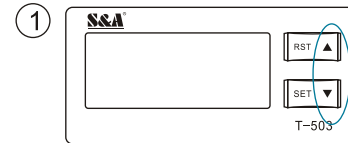

Press and hold ▲▼ buttons then turn on the chiller.

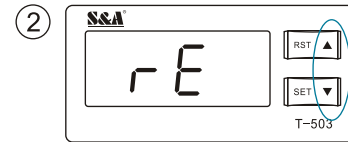

Release the buttons until rE displayed.



Actual water temperature is displayed.

## 5. Check the ambient temperature

Check the ambient temperature

Default display status:

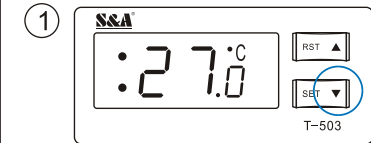

Press ▼ button to display ambient temperature.

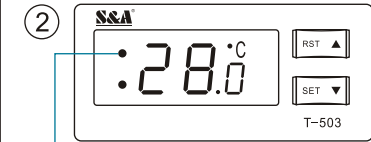

D1 flashes to show ambient temperature and default display is restored after 6 sec.

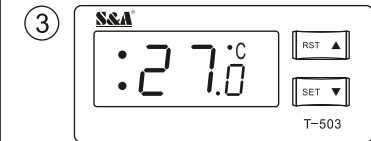

## 6. General settings adjustment

### Under constant temperature mode

Default display status:

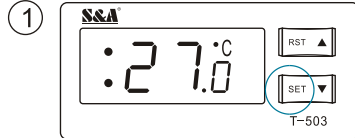

Press SET button to display set water temperature value.

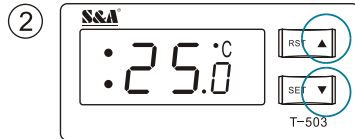

Press ▲ or ▼ button to modify temperature value.

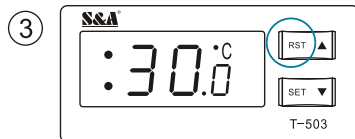

Press RST button to save and exit parameters setting and return to temperature display (if no button is pressed in 20 sec, the controller will automatically exit parameters setting without saving the modified values).

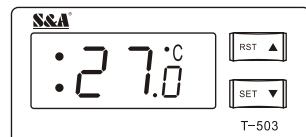

### Under intelligent temperature mode

Default display status:

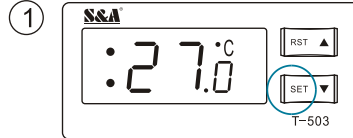

Press SET button to display temperature difference value.



Press ▲ or ▼ button to modify temperature difference value.



Press RST button to save and exit parameters setting and return to temperature display (if no button is pressed in 20 sec, the controller will automatically exit parameters setting without saving the modified values).



## 7. Advanced settings adjustment

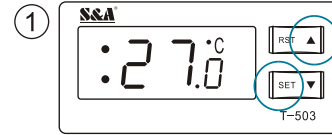

Press and hold ▲ button then press SET button for 5 sec until 0 is displayed.

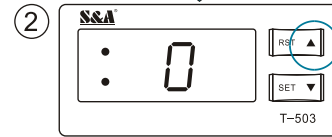

Press ▲ button to switch 0 to 8 (default password).

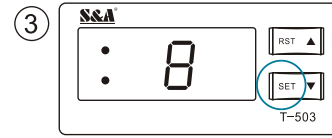

Press SET button to enter into set item code and F0 is displayed with correct password (it will return to actual water temperature if password is incorrect).

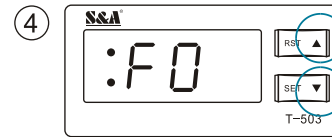

Press ▲ or ▼ button to modify set item codes F0 ~ F9.

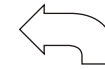

Press RST button to save and exit parameters setting and return to temperature display (if no button is pressed in 20 sec, the controller will automatically exit parameters setting without saving the modified values).

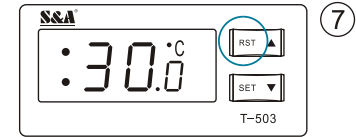

Press ▲ or ▼ button to modify set values parameters.

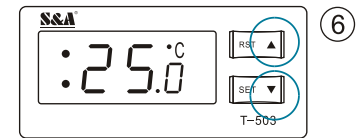

Press SET button to return to set item.

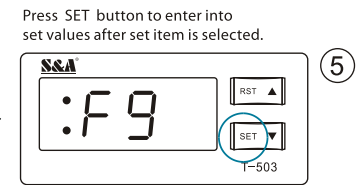

Press SET button to enter into set values after set item is selected.

### Note:

1. During parameters setting condition, system still runs under original parameters;
2. Under temperature control mode, the water temperature is controlled by (F0) parameters;
3. Under intelligent control mode, the water temperature will be automatically adjusted according to temperature changes. The temperature difference is commanded by (F1) parameter.

## 8. Advanced parameters adjustment case:

Order	Code	Item	Value in case 1	Value in case 2	Value in case 3	T-503 Temperature controller Factory Setting	T-504 Temperature controller Factory Setting
1	F0	Temperature setting	/	28	25	25	25
2	F1	Temperature difference values	-3	/	/	-2	-2
3	F2	Cooling hysteresis	0.5	2.0	1.0	0.8	0.3
4	F3	Way of control	1	0	0	1	0
5	F4	Alarm for ultrahigh water temperature	10	5	4	10	10
6	F5	Alarm for ultralow water temperature	10	10	14	15	15
7	F6	Alarm for ultrahigh room temperature	45	45	45	45	45
8	F7	Password	8	8	8	8	8
9	F8	The allowed highest water temperature	31	30	30	30	30
10	F9	The allowed lowest water temperature	25	5	5	20	20

- Case 1: cooling water temperature is controlled by intelligent mode. Requiring water temperature to be between 25°C and 31°C. Ambient temperature keeping constant, when the set water temperature is 3°C lower than the ambient, the fluctuation will not exceed ±0.5°C. There will be an alert when water temperature is 10°C lower or higher than target. (e.g. when ambient temperature is 30.0°C, cooling water temperature is between 27.5°C and 26.5°C, if ambient temperature is up to 30.5°C, water temperature will be between 28.0°C and 27.0°C.)
- Case 2: cooling water temperature is controlled by constant mode. Requiring water temperature is constant in 28°C, and the fluctuate does not exceed ±2°C. The ultrahigh water temperature alarm will be on when water temperature is 5°C higher than normal, and the ultralow water temperature alarm will be on when water temperature is 10°C lower than normal.
- Case 3: cooling water temperature is controlled by constant mode. Requiring water temperature is constant in 25°C, and the fluctuate does not exceed ±1°C. The ultrahigh water temperature alarm will be on then water temperature is higher than 30°C, and the ultralow water temperature alarm will be on when water temperature is lower than 10°C. (No matter what is the ambient temperature, the cooling water temperature is constant in 24.0°C to 26.0°C)

## 9. Temperature controller operation cases

How to set the water at 25°C in constant temperature mode under running in intelligent mode.

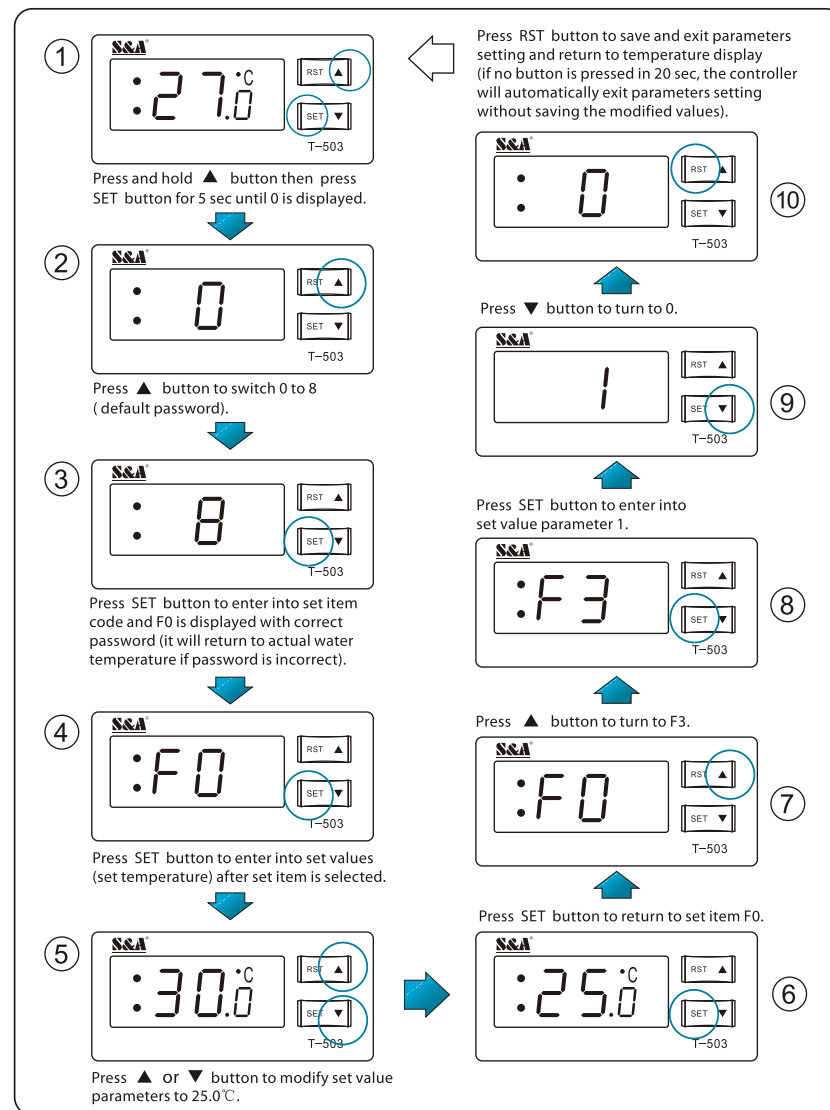

How to set -3.0°C temperature difference in intelligent mode under running in constant temperature mode.

① Press and hold ▲ button then press SET button for 5 sec until 0 is displayed.

② Press ▲ button to switch 0 to 8 (default password).

③ Press SET button to enter into set item code and F0 is displayed with correct password (it will return to actual water temperature if password is incorrect).

④ Press ▲ button to turn to set item F1.

⑤ Press SET button to enter into set values (set temperature) after set item is selected.

⑥ Press ▲ or ▼ button to modify set value parameters (temperature difference) to -3.0°C.

⑦ Press SET button to return to set item F1.

⑧ Press ▲ button to turn to F3.

⑨ Press ▲ button to enter into set value parameter 0.

⑩ Press ▲ button to turn to 1.

⑪ Press RST button to save and exit parameters setting and return to temperature display (if no button is pressed in 20 sec, the controller will automatically exit parameters setting without saving the modified values).

## FLOW ALARM AND OUTPUT PORTS

In order to guarantee the equipment will not be damaged while cooling water circulation is out of control, CW-5000/5200 series chillers possess a low flow alarm protection.

### 1. Flow alarm output ports and the wiring diagram

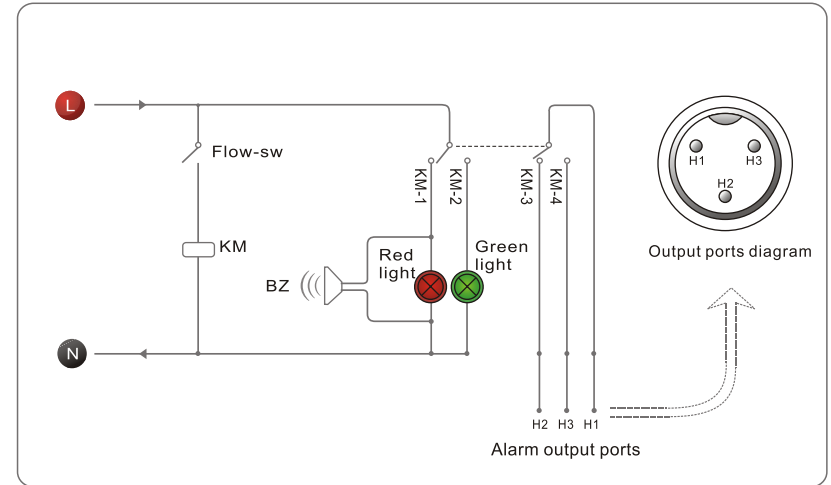

### 2. Flow alarm causes of circulating cooling water and working state

DISPLAY CONDITION	Normal flow indicator	Flow alarm indicator	BUZZER	OUT H1、H2	OUT H1、H3
Circulating pump works properly	● On	⊗ Off	⊗ No sound	⊗ Disconnection	■ Breakover
Blocked cooling water circulation loop	⊗ Off	● On	⊙ Sounds	■ Breakover	⊗ Disconnection
Alarm of water shortage	⊗ Off	● On	⊙ Sounds	■ Breakover	⊗ Disconnection
Faulted circulating pump	⊗ Off	● On	⊙ Sounds	■ Breakover	⊗ Disconnection
Power interruption	/	/	/	■ Breakover	⊗ Disconnection

Note: the flow alarm is connected to the normally open relay and normally closed relay contacts, requiring operating current less than 5A, working voltage less than 300V.

# SPECIFICATIONS

## CW-5000 Series compressional type chiller

MODEL	CW-5000AG	CW-5000BG	CW-5000DG	CW-5000AH	CW-5000BH	CW-5000DH	CW-5000AI	CW-5000BI	CW-5000DI
Voltage	AC 1P 220V	AC 1P 220V	AC 1P 110V	AC 1P 220V	AC 1P 220V	AC 1P 110V	AC 1P 220V	AC 1P 220V	AC 1P 110V
Frequency	50Hz	60Hz	60Hz	50Hz	50Hz	60Hz	50Hz	60Hz	60Hz
Current	0.15-2.2A	0.15-2.3A	0.3-4A	0.25-2.3A	0.25-2.4A	0.45-4.15A	0.7-2.75A		1-4.7A
Compressor power	0.295 KW	0.38KW	0.305KW	0.295 KW	0.38KW	0.305KW	0.295 KW	0.38KW	0.305KW
	0.40HP	0.52HP	0.41HP	0.40HP	0.52HP	0.41HP	0.40HP	0.52HP	0.41HP
Refrigeration capacity	2361Btu/h	2999Btu/h	2866Btu/h	2361Btu/h	2999Btu/h	2866Btu/h	2361Btu/h	2999Btu/h	2866Btu/h
	0.692KW	0.879KW	0.84KW	0.692KW	0.879KW	0.84KW	0.692KW	0.879KW	0.84KW
	595Kcal/h	756Kcal/h	722Kcal/h	595Kcal/h	756Kcal/h	722Kcal/h	595Kcal/h	756Kcal/h	722Kcal/h
Refrigerant	R-134a								
Refrigerant charge	300g	320g	280g	300g	320g	280g	300g	320g	280g
Precision	± 0.3°C								
Reducer	Capillary								
Protection	Overcurrent protection for compressor, flow alarm, over temperature alarm								
Pump power	0.03KW			0.05KW			0.1KW		
Tank capacity	6L								
Inlet and outlet	External Φ10mm barbed connector						Φ10mm speedy connector		
Max. Lift	10M			12M			25M		
Max. Flow	10L/min			13L/min			16L/min		
N.W	24Kgs								
G.W	27Kgs								
Dimension	58 X 29 X 47 cm (L * W * H)								
Package dimension	70 X 43 X 58 cm (L * W * H)								

Note: other electric sources can be customized; heating and higher temperature control precision functions are optional.

## CW-5200 Series compressional type chiller





MODEL	CW-5200AG	CW-5200BG	CW-5200DG	CW-5200TG	CW-5200AH	CW-5200BH	CW-5200DH	CW-5200AI	CW-5200BI	CW-5200DI
Voltage	AC 1P 220V	AC 1P 220V	AC 1P 110V	AC 1P 220V	AC 1P 220V	AC 1P 220V	AC 1P 110V	AC 1P 220V	AC 1P 220V	AC 1P 110V
Frequency	50Hz	60Hz	60Hz	50/60 Hz	50Hz	60Hz	60Hz	50Hz	60Hz	60Hz
Current	0.15-3.8A	0.15-4A	0.3-5.55A	0.15-3.8A	0.25-3.9A	0.25-4.1A	0.45-5.7A	0.7-4.35A	0.7-4.55A	1-6.25A
Compressor power	0.52KW	0.5KW	0.68KW	0.49/0.57KW	0.52KW	0.5KW	0.68KW	0.52KW	0.5KW	0.68KW
	0.71HP	0.68HP	0.93HP	0.66/0.77HP	0.71HP	0.68HP	0.93HP	0.71HP	0.68HP	0.93HP
Refrigeration capacity	5084Btu/h	4982Btu/h	5186Btu/h	4825/5797Btu/h	5084Btu/h	4982Btu/h	5186Btu/h	5084Btu/h	4982Btu/h	5186Btu/h
	1.49KW	1.46KW	1.52KW	1.41/1.70KW	1.49KW	1.46KW	1.52KW	1.49KW	1.46KW	1.52KW
	1281Kcal/h	1256Kcal/h	1307Kcal/h	1219/1465Kcal/h	1281Kcal/h	1256Kcal/h	1307Kcal/h	1281Kcal/h	1256Kcal/h	1307Kcal/h
Refrigerant	R-22 / R-410a									
Refrigerant charge	360g	380g	350g	360/380g	360g	380g	350g	360g	380g	350g
Precision	± 0.3°C									
Reducer	Capillary									
Protection	Overcurrent protection for compressor, flow alarm, over temperature alarm									
Pump power	0.03KW				0.05KW			0.1KW		
Tank capacity	6L									
Inlet and outlet	External Φ10mm barbed connector						Φ10mm speedy connector			
Max. Lift	10M			12M			25M			
Max. Flow	10L/min			13L/min			16L/min			
N.W	26Kgs									
G.W	29Kgs									
Dimension	58 X 29 X 47 cm (L * W * H)									
Package dimension	70 X 43 X 58 cm (L * W * H)									

Note: other electric sources can be customized; heating and higher temperature control precision functions are optional.

# SIMPLE TROUBLESHOOTING

FAILURE	FAULT CAUSE	APPROACH
Machine turned on but unelectrified	Power cord is not plugged in place	Check and ensure the power interface and the power plug is plugged in place and in good contact.
	Fuse burnt-out	Replace the protective tube in the power socket on the back of chiller.
Flow Alarm (panel red light is on) use a water pipe directly connect to the water outlet and inlet but still without water flowing	Water level in the storage water tank is too low	Check the water level gauge display, add water until the level shown in the green area; And check whether water circulation pipe leaks.
Flow alarm occurs while running with other equipment (panel red light is on), but there is water flowing and no alarm when use a water pipe directly connected to the chiller water outlet and inlet.	Water circulation pipes are blocked or a pipe bending deformation.	Check water circulation pipe
Ultrahigh water temperature alarm (controller displays E2)	Blocked dust gauze, bad thermolysis	Unpick and wash the dust gauze regularly
	Poor ventilation for air outlet and inlet	To ensure a smooth ventilation for air outlet and inlet
	Voltage is extremely low or unstable	To improve the power supply circuit or use a voltage regulator
	Improper parameter settings on thermostat	To reset controlling parameters or restore factory settings
	Switch the power frequently	To ensure there is sufficient time for refrigeration (more than 5 minutes)
Ultrahigh room temperature alarm (controller displays E1)	Excessive heat load	Reduce the heat load or use other model with larger cooling capacity
	The working ambient temperature is too high for the chiller	To improve the ventilation to guarantee that the machine is running under 40°C.
Serious problem of condensate water	Water temperature is much lower than ambient temperature, with high humidity	Increase water temperature or to preserve heat for pipeline
Water drains slowly from drainage nozzle during water changing	Water supply inlet is not open	Open the water supply inlet

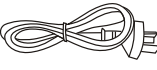
# PACKING LIST

1 1 unit of industrial chiller	2 1 copy of user manual	3 1 pc of power cord	4 1 pc of connection hose
			
5 2 pcs of sealed hoop (optional)	6 1 pc of alarm signal output plug	7 1 pc of spare fuse (Held in the spare fuseholder of power socket)	
