

CWFL-800/1000/1500 FIBER LASER SPECIAL CHILLER USER MANUAL

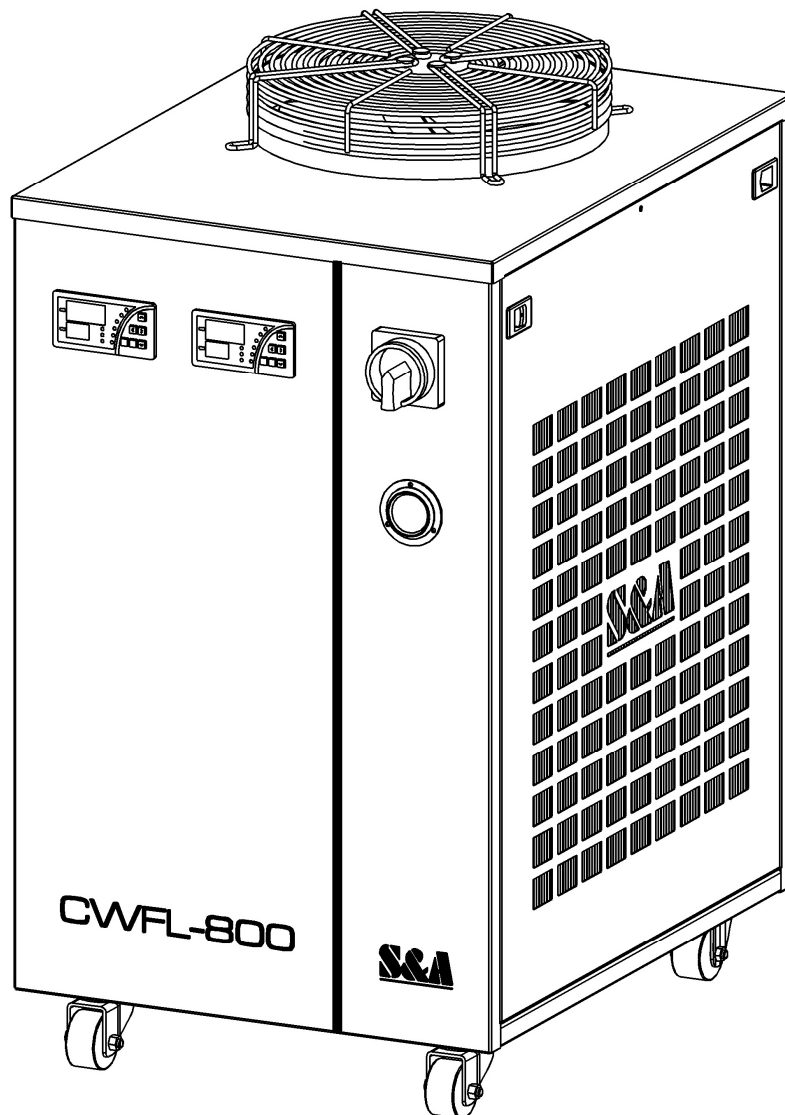

Contents

<1> Cautions	-----	3
<2> Contour and parts introduction	-----	4
<3> Installation	-----	5
<4> Operation and parameters adjustment	-----	6
<5> Flow alarm and output ports	-----	10
<6> Simple troubleshooting	-----	14

Thank you for using the machine from GUANGZHOU TEYU ELECTROMECHANICAL CO., LTD. Please read the installation instructions carefully before installing and operating and keep it properly.

This installation instructions is not a quality assurance. GUANGZHOU TEYU ELECTROMECHANICAL CO., LTD reserves the right to the interpretation of correction of typographical errors, improper mentioned information and product improvement. The amended content will be reprinted in installation instructions without notice in advance.

<1> Cautions

1. Please ensure that the power supply and electrical outlet are in good contact and the earth wire must be firmly grounded!
2. Please make sure there is stable and normal voltage for the working chiller!
As the refrigeration compressor is more sensitive to the power supply and voltage, so the operating voltage of our standard product is of 210 ~ 240V (110V model is of 100 ~120V). If you do need a wider operating voltage range, customization is available for us.
3. Unmatched power frequency can cause the chiller damage!
Please choose model of 50Hz or 60Hz according to actual circumstance.
4. To protect the pump, it's strictly forbidden to run the chiller without water in the storage water tank!
The new machine is packed after draining whole water in the tank, so please make sure the tank has water inside before machine starting, otherwise it's easily to have the pump damaged. When the water level is below the green (NORMAL) range of the water level gauge, the cooling capacity of our chiller will go down slightly. Hence please ensure the water level is within the green (NORMAL) range. To drain through circulating pump is strictly prohibited!
5. Please be sure that the air inlet and air outlet are in good ventilation!
There must be at least 50cm from obstructions to the air outlet which is in the back of the cooler, and should leave at least 30cm between obstructions and the side air inlet.
6. The filter gauze must be regularly cleaned!
It's essential to remove and wash the dust gauze regularly, otherwise chiller malfunction can be caused by serious blockage.
7. Please pay attention to the effect of the condensate water!
With greater ambient humidity, when the water temperature is lower than the ambient temperature, the condensate water will generate on the surface of water circular pipes and the cooled components. If above circumstance appears, it is recommended to set a higher water temperature or keep pipes and cooled parts warm.
8. This product is an industrial equipment. For professional use only.

<2> Contour and parts introduction

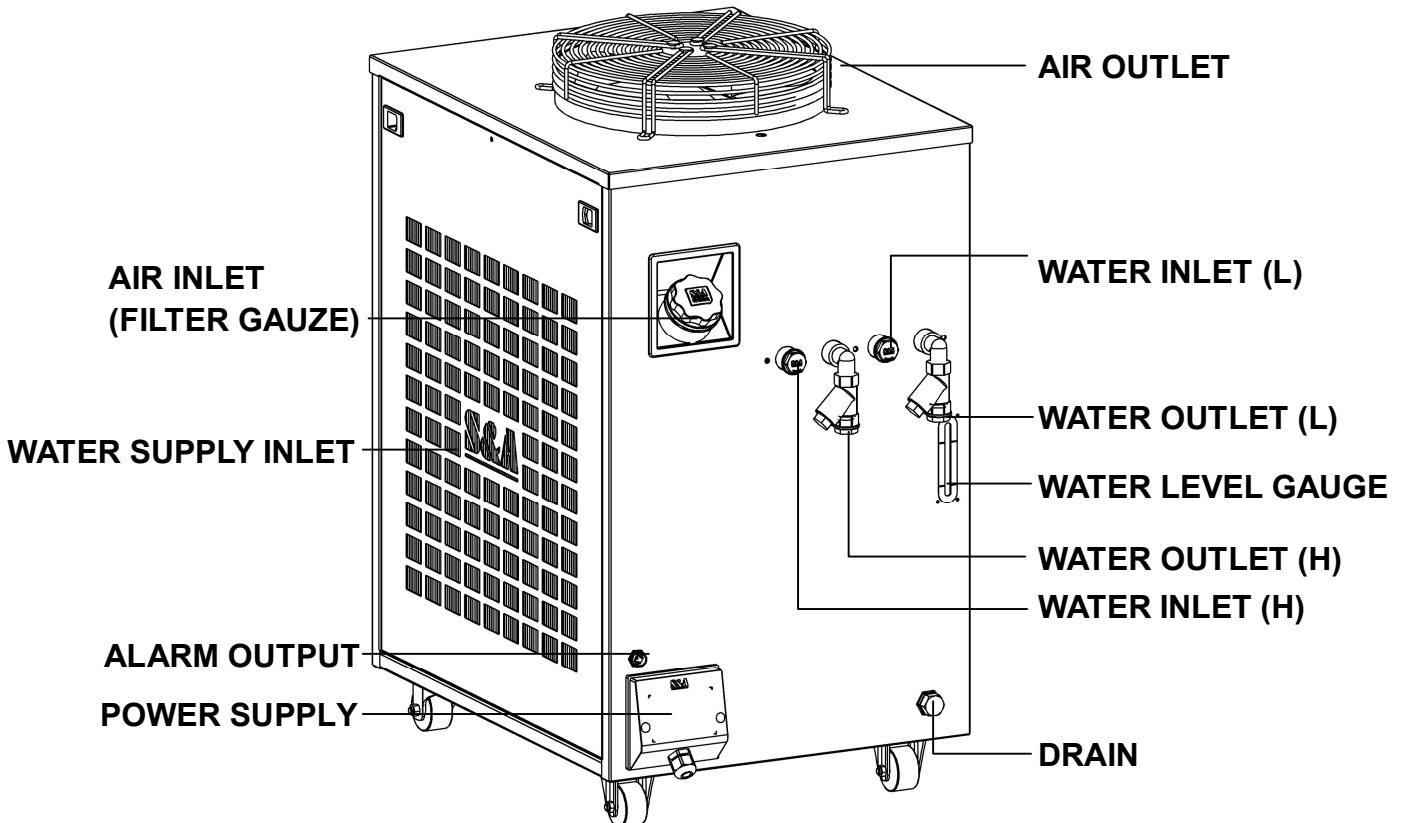
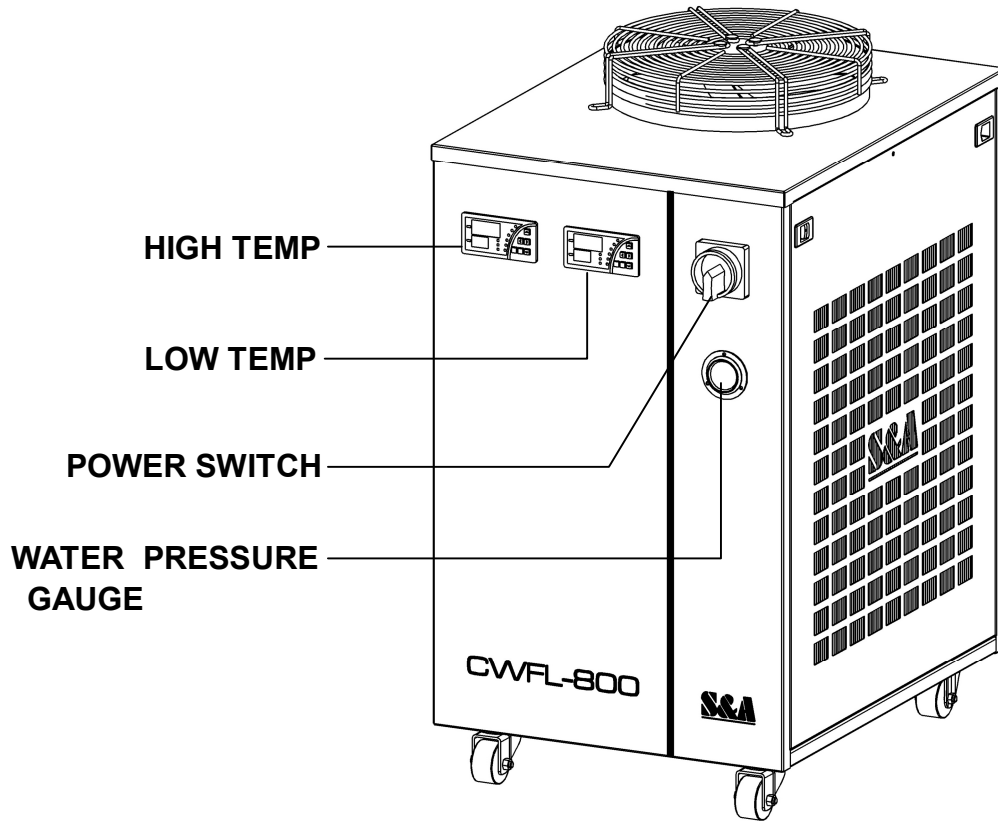

<3> Installation

It is very simple to install this industrial cooling machine. The installation for the first time of the new machine can be carried out by following steps:

1. Open the package to check if the machine is intact and all the necessary accessories are completed.
2. Open the water supply lid to feed cooling water.
Observing the water level gauge to feed water slowly, be careful not to have the water overflowed!
3. According to system conditions, please connect the water inlet and outlet pipe properly.
4. Plug in power, turn on the power switch. (Do not start up without water in the water tank!)
 - (1) Power switch turned on, the circulation pump of the chiller starts working. The first time of operating may cause more bubbles in the pipe leading to a flow alarming occasionally, but running for a few minutes later, it will go back to normal.
 - (2) If the chiller starts for the first time, you must immediately check whether the water pipe leaks.
 - (3) Power switched on, if the water temperature is under the set value, it is normal that fans and other components of the machine do not work. The temperature controller will automatically control the working conditions of the compressor, magnetic valve, fans and other parts based on the set controlling parameters.
 - (4) As it takes a longer time to start over the compressor and other components, according to different conditions, the time is range from seconds to minutes, so do not turn on and off frequently.
5. Check the water level in the water tank.
The first starting up of a new chiller will empty the air in the water pipe, causing a slight water level decline, but in order to keep the water level in the green area, it is allowed to add adequate water again. Please observe and record the current water level, and inspect it again after the chiller running for a period of time, if the water level drops obviously, please re-inspect the water pipeline leakage.
6. Adjust parameters of temperature controller.
CWFL-800/1000/1500 series use an intelligent thermostat. Normally users do not need to adjust the parameters. If it is necessary, please refer to page 6, "Operating status and parameters adjustment."

<4> Operation status and parameters adjustment

The new T-506A intelligent temperature controller does not need to adjust the controlling parameters under normal circumstance. It will self-adjust controlling parameters according to room temperature for meeting equipment cooling requirements.

The new T-506B intelligent temperature controller is selected constant temperature control mode as factory setting with water temperature at 25°C. User can adjust it as needed.

T-506A and T-506B controllers are of same functions and structure except default setting.



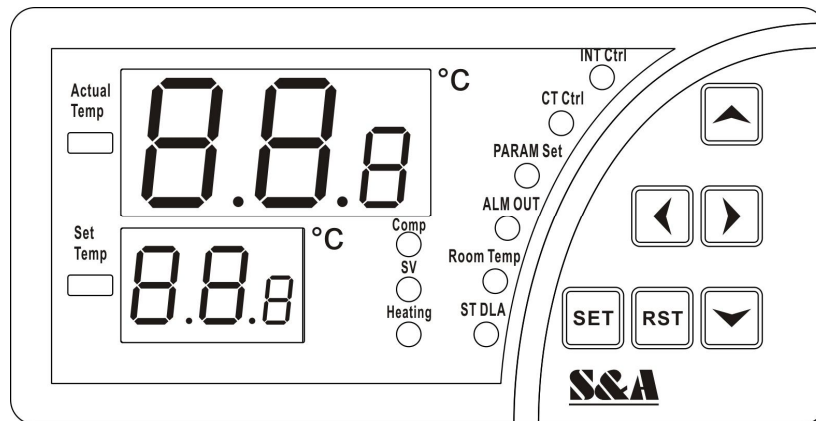

1. Temperature control panel introduction



(1). Indicators of temperature controller working status:



COMP	ON, compressor working
SV	ON, solenoid valve working
Heating	ON, heating rod working
INT Ctrl	ON, controller working in intelligent control mode
CT Ctrl	ON, controller working in constant temperature control mode
PARAM Set	ON, controller working in parameters setting mode
ALM OUT	ON, alarm output status
Room Temp	ON, displaying room temperature
ST DLA	ON, starting up delay status

(2). Press  key to show the room temperature, 6 seconds later default display restored. (Meanwhile, Room Temp light is on, displaying room temperature.)

(3).   keys are for modifying parameters values and   keys are for switching parameter items.

- (4). RST key: confirm
- (5). SET key: setting function

2. Restore to factory settings

Before machine startup, press and hold   keys until the controller displays rE, 6 seconds later after releasing the keys, the controller works in normal order. All parameters values settings of the controller have been restored to factory settings.

3. Alarm function

(1) Alarm Display:

When alarm occurs, the error code and the temperature will be alternately displayed.

E1	E2	E3	E4	E5	E6
Ultrahigh room temperature	Ultrahigh water temperature	Ultralow water temperature	Room temperature sensor failure	Water temperature sensor failure	External alarm input

(2) To suspend the alarm:

In alarming state, the alarm sound could be suspended by pressing any button, but the alarm display remains until the alarm condition is eliminated.



4. Temperature controller parameters list

Order	Code	Item	Range	T--506A Temperature controller Factory Setting	T--506B Temperature controller Factory Setting	Note
1	F0	Temperature setting	F9~F8	30	25	Constant temperature control effecting
2	F1	Temperature Difference values	-15~+5	-2	-2	Intelligent control effecting
3	F2	Cooling hysteresis	0.1~3.0	0.3	0.3	
4	F3	Way of control	0~1	1	0	1: intelligent 0: constant temperature
5	F4	Alarm for ultrahigh water temperature	1~20	10	10	
6	F5	Alarm for ultralow water temperature	1~20	20	15	
7	F6	Alarm for ultrahigh room temperature	40~50	45	45	
8	F7	Password	00~99	8	8	
9	F8	The allowed highest water temperature	(F9+1)~40	35	30	
10	F9	The allowed lowest water temperature	1~(F8-1)	25	20	

5. General settings adjustment



Press SET key to enter into the user-defined state. Meanwhile, PARAM SET is on, controller in parameters setup status.

- (1) Under intelligent mode, the control panel displays the temperature difference value between water and air (default value is -2).
- (2) Under constant temperature mode, the control panel displays the set temperature value (default value is 25).



At this moment, press   keys to change settings. After modifying the value, press RST key to save and exit, then new parameters take effect, or press SET key to exit without saving parameters. If there is no more action within 20 seconds, it will automatically exit modifying status without saving parameters.

6. Advanced settings adjustment

- (1) Press and hold the  key while press SET key for 5 seconds until 00

displayed in upper window and PAS in lower window. Then press   keys to select the password (default setting is 8), and then press the SET key, if the password is correct, F0 displays, entering into setup status, D1 flashing to indicate that the controller is under parameters setup status. If the password is incorrect, it returns to temperature display.

- (2) Enter setup state, press   keys to switch parameter items circularly,

then press   keys to modify the parameter values. Press enter key RST at any time to exit parameters setup with saving modified parameters and return to temperature display, then chiller runs under the new parameters. If no key is pressed within 20 seconds, the controller will automatically exit parameters setup without saving the modified parameters (under parameters setup status, system running in original parameters). Under parameters setup status, SET key does not work.

Note:

1. During parameters setting condition, system runs under original parameters.
2. Under constant temperature control mode, the water temperature is controlled by parameter F0;
3. Under intelligent control mode, the water temperature will be automatically adjusted according to temperature changes. The temperature difference is commanded by F1.

7. Advanced parameters adjustment cases:

Order	Code	Item	Value in case 1	Value in case 2	T--506A Temperature controller Factory Setting	T--506B Temperature controller Factory Setting
1	F0	Temperature setting	28	20	30	25
2	F1	Temperature Difference values			-2	-2
3	F2	Cooling hysteresis	2.0	1.0	0.3	0.3
4	F3	Way of control	0	0	1	0
5	F4	Alarm for over high water temperature	5	4	10	10
6	F5	Alarm for over low water temperature	10	14	20	15
7	F6	Alarm for over high Room temperature	45	45	45	45
8	F7	Password	8	8	8	8
9	F8	The allowed highest water temperature	30	30	35	30
10	F9	The allowed lowest water temperature	5	5	25	20

- (1) Case 1: cooling water temperature is controlled by constant mode. Requiring water temperature is constant in 28°C, and the fluctuate does not exceed $\pm 2^\circ\text{C}$. The alarm of over high water temperature will be on when water temperature is 5°C higher than normal value, and the alarm of over low water temperature will be on when water temperature is 10°C lower than normal value. It is convenient for user to adjust the water temperature between 5-30°C.
- (2) Case 2: cooling water temperature is controlled by constant mode. Requiring water temperature is constant in 20°C, and the fluctuate does not exceed $\pm 1^\circ\text{C}$. The over high water temperature will be on when water temperature is higher than 25°C, and the alarm of over low water temperature will be on when water temperature is lower than 5°C. (Regardless of what is the ambient temperature, the cooling water temperature is constant in 19°C to 21°C)

<5> Flow alarm and output ports

In order to guarantee the equipment will not be damaged while cooling water circulation is out of control, CWFL-800/CWFL-1000 dual temperature series chiller possesses a low flow alarm protection.

(1) Flow alarm output ports and the wiring diagram

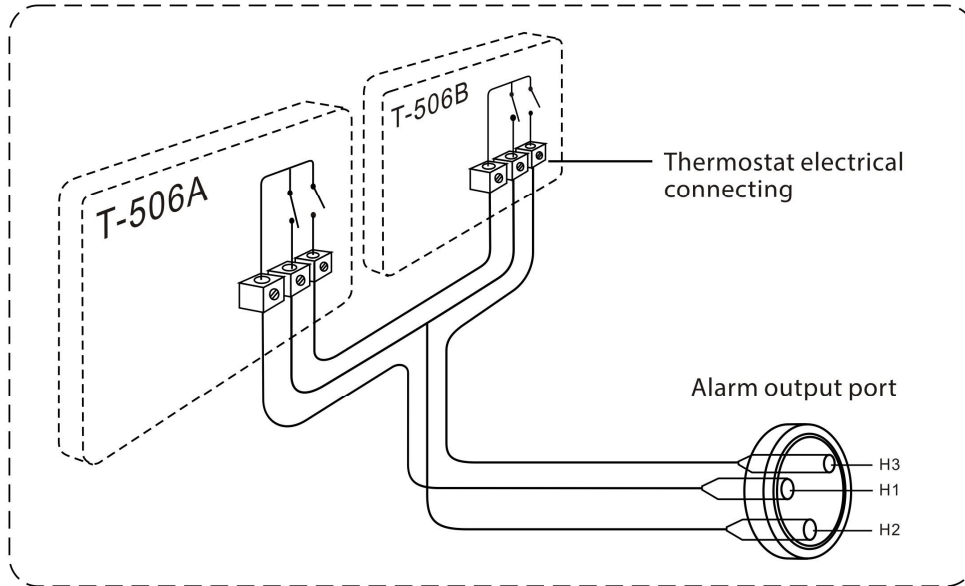

2. Alarm causes and working status table.

Condition \ Display	Alarm code	Buzzer	OUT H1、H2	OUT H1、H3
Circulating pump works properly			DISCONNECTI ON	BREAKEVER
Blocked cooling water circulation loop	E6	Sounds	BREAKEVER	DISCONNECTION
Alarm of water shortage	E6	Sounds	BREAKEVER	DISCONNECTION
Faulted circulating pump	E6	Sounds	BREAKEVER	DISCONNECTION
Ultrahigh room temp	E1	Sounds	BREAKEVER	DISCONNECTION
Ultrahigh water temp	E2	Sounds	BREAKEVER	DISCONNECTION
Ultralow water temp	E3	Sounds	BREAKEVER	DISCONNECTION
Faulted room temp sensor (constant temp invalid)	E4	Sounds	BREAKEVER	DISCONNECTION
Faulted water temp sensor	E5	Sounds	BREAKEVER	DISCONNECTION
Chiller power failure			BREAKEVER	DISCONNECTION

Note: The flow alarm is connected to the normally open relay and normally closed relay contacts, requiring operating current less than 5A, working voltage less than 300V.

<6> Simple troubleshooting

Failure	Failure Cause	Approach
Machine turned on but unelectrified	Power cord is not plugged in place	Check and ensure the power interface and the power plug is plugged in place and in good contact.
	Fuse burnt-out	Open the electric box cover, check the protective tube, replace with spare one if necessary and check whether the power supply voltage is stable; Check and ensure the power interface and the power plug are in good contact.
Flow Alarm (controller displays E6) use a water pipe directly connect to the water outlet and inlet but still without water flowing	Water level in the storage water tank is too low	Check the water level gauge display, add water until the level shown in the green area; And check whether water circulation pipe leaks.
Flow alarm occurs while running with other equipment (controller displays E6), but there is water flowing and no alarm when use a water pipe directly connected to the chiller water outlet and inlet.	Water circulation pipes are blocked or a pipe bending deformation.	Check water circulation pipe
Ultra-high temperature alarm (Temperature controller panel display E2)	Blocked dust gauze, bad thermolysis	Unpick and wash the dust gauze regularly
	Poor ventilation for air outlet and inlet	To ensure a smooth ventilation for air outlet and inlet
	Voltage is extremely low or astable	To improve the power supply circuit or use a voltage regulator
	Improper parameter settings on thermostat	To reset controlling parameters or restore factory settings
	Switch the power frequently	To ensure there is sufficient time for refrigeration (more than 5 minutes)
	Excessive heat load	Reduce the heat load or use other model with larger cooling capacity
Alarm for ultra-high room temperature(Temperature controller panel display E1)	The working ambient temperature is too high for the chiller	To improve the ventilation to guarantee that the machine is running under 40℃.
Serious problem of condensate water	Water temperature is much lower than ambient temperature, high humidity	Increase water temperature or to preserve heat for pipeline
Water drains slowly from outfall during water changing	Injection port is not open	Open the injection port

CWFL-800/1000/1500 光纤激光器专用冷水机 使用安装说明书

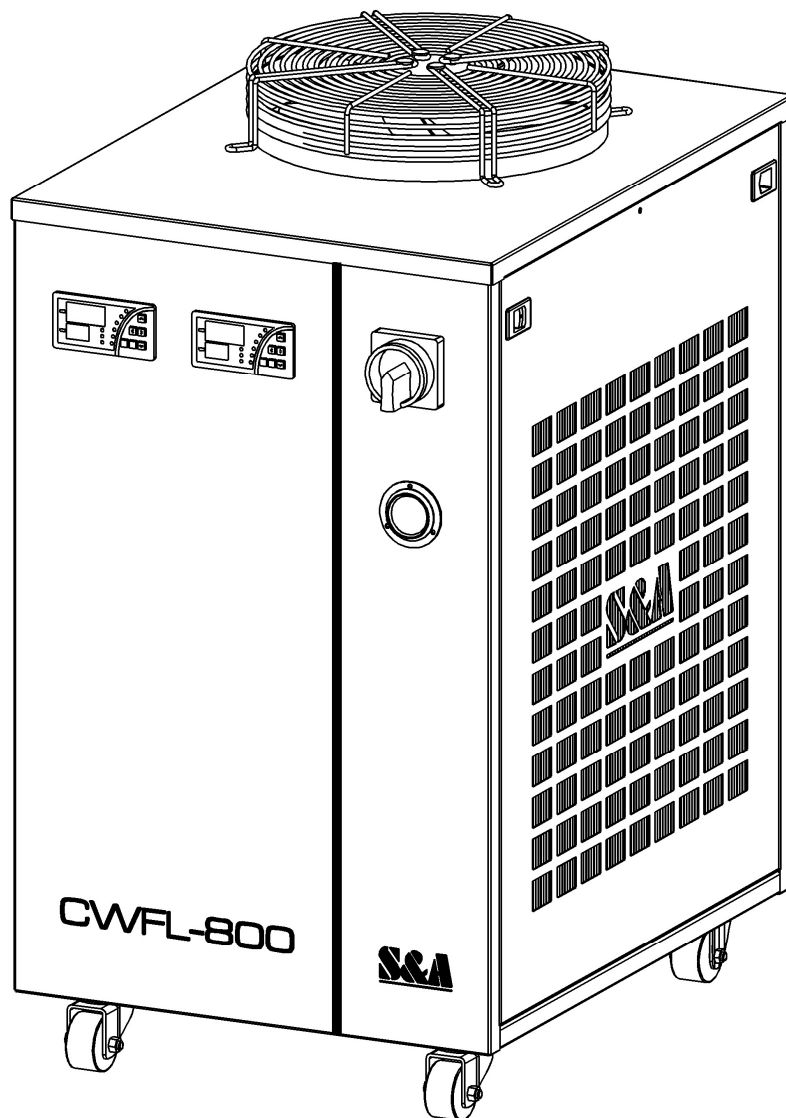

目 录

一. 使用注意事项	-----	14
二. 外形及部件名称	-----	15
三. 安装说明	-----	16
四. 运行状况与参数调整	-----	17
五. 流量报警与输出端口	-----	21
六. 简单故障处理	-----	22

感谢您购买广州特域机电有限公司的产品，请在使用前仔细阅读使用安装说明书，并妥善保管。

本使用安装说明书并非质量保证书，对印刷错误的更正，所述信息谬误的勘误，以及产品的改进，均由广州特域机电有限公司随时做出解释，恕不预先通知，修正内容将编入再版使用安装说明书中。

一、使用注意事项

1、请确保电源插座接触良好并且地线可靠接地！

2、请确保冷水机的工作电压稳定、正常！

由于制冷压缩机对电源电压比较敏感，我公司标准产品的正常工作电压为210~240V(110V 机型为 100~120V)。如果确实需要更宽的工作电压范围，可以另行定制。

3、电源频率不匹配会导致机器损坏！

请根据实际情况，使用 50Hz 或 60Hz 的机型。

4、为保护循环水泵，严禁无水运行！

新机装箱前都排空了储水水箱，请确保水箱注水后再开机，否则水泵极易损坏。当水箱水位在水位计绿色（NORMAL）范围以下时，冷却机制冷量会轻微下降，请保证水箱水位在水位计的绿色（NORMAL）范围内。严禁使用循环泵排水！

5、请确保冷水机入风、出风通道顺畅！

冷水机上面的出风口距离障碍物要留有 **50cm** 以上的距离，侧面的入风口离障碍物要求距离在 **30cm** 以上。

6、入风口的滤网必须定期清洗！

必须定期拆洗防尘网，防尘网严重堵塞会引起冷水机故障。

7、请注意冷凝水的影响！

当水温低于环境温度，并且环境湿度较大时，循环水管与被冷却器件表面会产生冷凝水。当出现以上情况时，建议调高水温或对水管与被冷却器件进行保温。

8、本产品为工业设备，请勿让非专业人士操作。

二、外形及部件名称

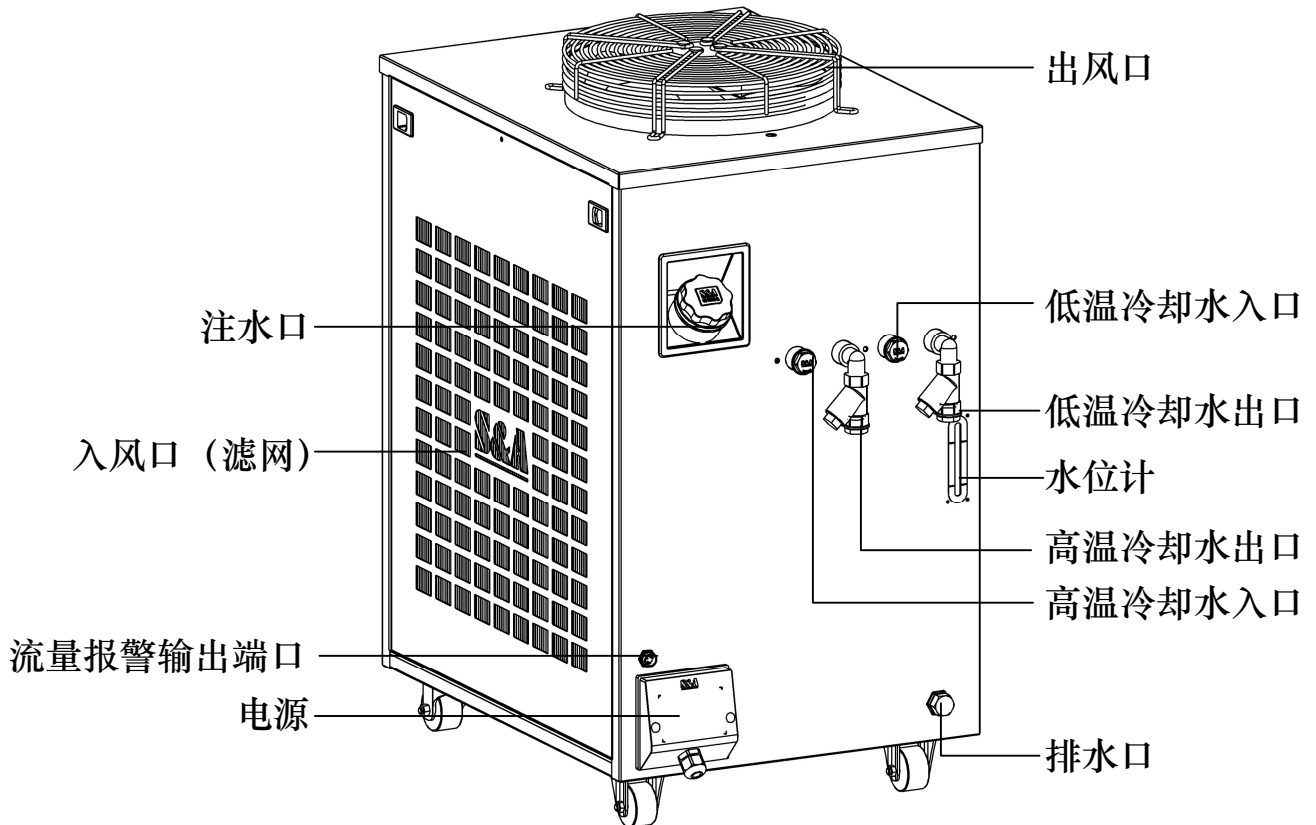
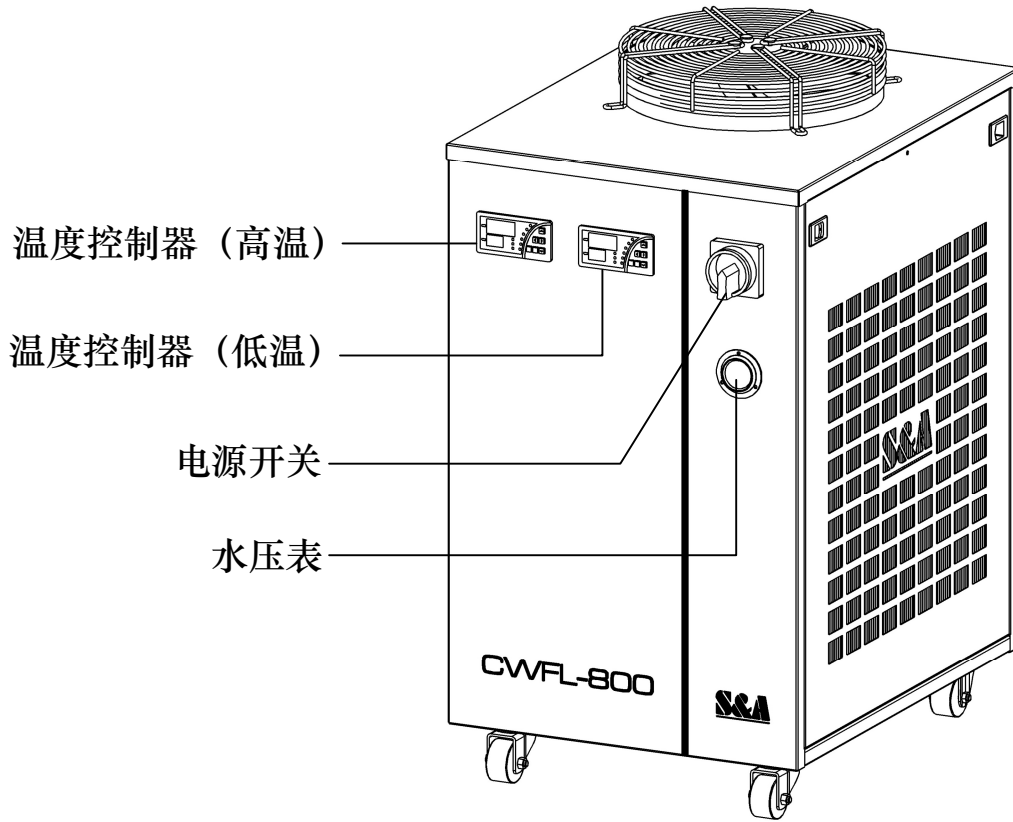

三、安装说明

冷水机安装使用非常简单，新机首次使用可按以下步骤进行：

1、打开包装，检查机器是否完好，附件是否齐备。

2、拧开机器注水口，加入冷却水。

加水时应同时观察水位计的水位慢慢加水，注意不要让水溢出！

3、根据设备情况接好出水管、入水管。

4、插上电源线，打开电源开关。（严禁无水开机！）

(1) 打开电源开关后，冷水机循环泵就开始工作了。新机第一次开机时管路中会有较多的气泡导致机器偶尔流量报警，运行数分钟后就会恢复正常。

(2) 第一次开机后，必须马上检查水管管路有无漏水。

(3) 打开电源后，如果水温低于设定温度，机器风扇等器件不工作是正常现象。温控器会根据设定的控制参数自动控制压缩机、电磁阀、风扇等器件的工作状态。

(4) 由于压缩机等器件有一个较长的启动过程，根据不同的工况从几十秒到数分钟不等，所以不要频繁开关机。

5、检查水箱水位。

新机开机后排空了水管中的空气，水箱水位会略有下降，为了保持水位在绿色区域，可以再次适量加水。观察并记下当前的水位情况，等冷水机运行一段时间后再观察水位计，如果水位下降明显，就要再次检查水管管路的渗漏情况。

6、调整温控器参数。

CWFL-800/1000/1500 双温系列冷水机使用的智能温控器一般情况下不需要调整控制参数，如确实必要的，可参考第 17 页《运行状况与参数调整》。

四、运行状况与参数调整

T--506A 新型智能控制器一般情况下不需要调整控制参数，它会根据室温的变化自动调整控制参数，保证满足设备的冷却要求。

T--506B 新型智能控制器出厂设定为恒温温控模式，水温设定为 25 度，用户可以根据需要调整。

T--506A、T--506B 温控器除出厂设定参数不同外，其功能、结构是一样的。

1、温度控制器面板介绍

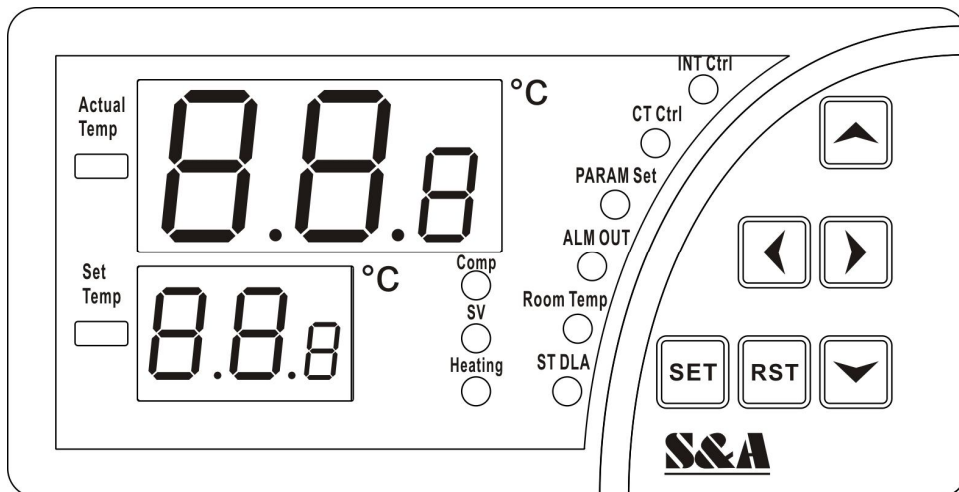





(1) 温控器工作状态指示灯（如图）

Comp	指示灯亮，	表示压缩机启动。
SV	指示灯亮，	表示电磁阀启动。
Heating	指示灯亮，	表示电发热棒启动。
INT Ctrl	指示灯亮，	指示控制器工作在智能控制模式；
CT Ctrl	指示灯亮，	指示控制器工作在恒温控制模式；
PARAM Set	指示灯亮，	指示控制器工作在参数设定模式；
ALM OUT	指示灯亮，	指示报警输出状态；
Room Temp	指示灯亮，	指示显示室温状态；
ST DLA	指示灯亮，	指示处于开机延时状态；

(2) 按  键会显示室温温度，6 秒后恢复默认显示。



（此时“Room Temp”亮，表明显示为室温。）

(3)   键变更参数值，  变更参数项。

(4) “RST” 键 确定按键

(5) “SET” 键 设定功能按键

2、恢复出厂设定

开机前，同时按下“ ”键不放然后开机，直至控制器显示“rE”。松开按键 6 秒后控制器进入正常的工作状态。这时控制器所有参数设定值均已恢复为出厂设定值。

3、报警功能

(1) 报警显示:

报警时，出错的代码与水温会交替显示。

E1	E2	E3	E4	E5	E6
室温超高	水温超高	水温超低	室温传感器故障	水温传感器故障	外部报警输入

(2) 暂停报警声:

在报警状态下按任何键均可停报警声响，但报警显示需等到报警条件消除后才停止。



4、温控器控制参数表

次序	代码	设定项目	范 围	T--506A 温控器 出厂设定	T--506B 温控器 出厂设定	备 注
1	F0	设定温度	F9~ F8	30	25	恒温工作模式有效
2	F1	温差数值	-15~+5	-2	-2	智能控制方式有效
3	F2	制冷回差	0.1~3.0	0.3	0.3	
4	F3	控制方式	0~1	1	0	1 智能、0 恒温
5	F4	水温超高报警	1~20	10	10	
6	F5	水温超低报警	1~20	20	15	
7	F6	气温超高报警	40~50	45	45	
8	F7	密码	00~99	8	8	
9	F8	最高设定水温	(F9+1) ~40	35	30	
10	F9	最低设定水温	1 ~ (F8-1)	25	20	







5、一般设定调整

按设定键“SET”进入用户设定状态，此时“PARAM Set”灯亮，表明现在控制器为参数设定状态

- (1) 智能模式下显示水温与气温的温差参数值。(出厂设定值为-2)
- (2) 恒温模式下显示设定水温的数值。(出厂设定值为 25)

此时按“ ”键可修改设定值，修改数值后按下确认键“RST”后存盘退出，新参数生效。如 20 秒内无按键按下，不保存参数自动退出修改状态。

6、高级设定调整

- (1) 按住“”键不放，同时按设定键“SET”五秒至上限窗显示“00”，下显示窗显示“PAS”，此时按“ ”键选择已设定密码（出厂设定为 8），再按一下设定键“SET”，如密码正确，显示转为“F0”，进入设定状态，表明现在控制器为参数设定状态。如密码错误，则返回温度显示。
- (2) 进入设定状态后按“ ”键循环依次改变参数项，按键“ ”则更改该参数项的参数值。任何时候按确定键“RST”，则保存修改的参数退出参数设定状态，返回温度显示，并按新参数运行。如20秒内无按键按下，控制器也会自动退出参数设定状态，并且不保存修改的参数。(在参数设定状态时，系统按原参数运行。)，在参数设置状态下，按“SET”键不响应。

- 注：1、在参数设定状态时，系统按原参数运行；
- 2、恒温控制模式时，水温由“F0”参数控制；
 - 3、智能控制模式时，水温会根据气温变化自动调整。其温差由“F1”参数控制。

7、高级控制参数调整案例

次序	代码	设定项目	案例一 设定值	案例二 设定值	T--506A 温控 器 出厂设定	T--506B 温控 器 出厂设定
1	F0	设定温度	28	20	30	25
2	F1	温差数值			-2	-2
3	F2	制冷回差	2.0	1.0	0.3	0.3
4	F3	控制方式	0	0	1	0
5	F4	水温超高报警	5	4	10	10
6	F5	水温超低报警	10	14	20	15
7	F6	气温超高报警	45	45	45	45
8	F7	密码	8	8	8	8
9	F8	最高设定水温	30	30	35	30
10	F9	最低设定水温	5	5	25	20

- (1)、案例一：恒温模式控制冷却水温度。要求冷却水温度恒定在 28 度、水温波动不大于正负 2 度。水温超过正常水温 5 度即超高温报警，低于正常水温 10 度时即超低温报警。并且可以方便地通过用户设定在 5 至 30 度之间调整水温设定。
- (2)、案例二：恒温模式控制冷却水温度。要求冷却水温度恒定在 20 度、水温波动不大于正负 1 度。水温超过 25 度即超高温报警，低于 5 度时，超低温报警。（即不管气温多少度，冷却水温恒定在 19 度至 21 度之间。）

五、流量报警与输出端口

为了保证在冷却水循环出现异常情况时不影响设备的安全，CWFL-800/1000/1500 双温系列冷水机设有低流量报警保护功能。

1、流量报警输出端及接线示意图

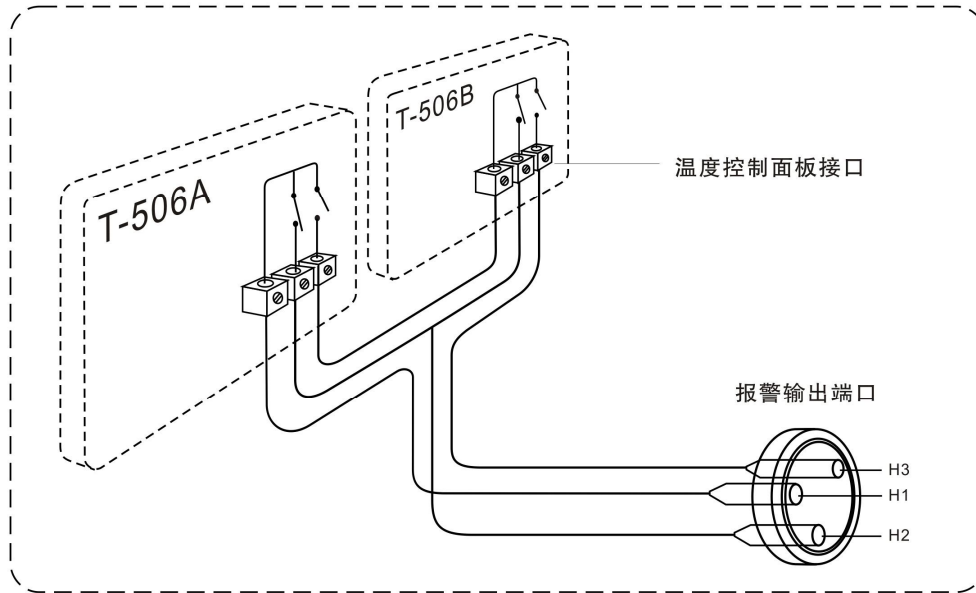

2、报警原因与工作状态表.

系统指示 工作状态	报警代码	蜂鸣器	输出端口 H1、H2	输出端口 H1、H3
循环水泵正常工作			断路	导通
冷却水循环回路堵塞	E6	发声	导通	断路
缺水报警	E6	发声	导通	断路
循环水泵故障	E6	发声	导通	断路
室温超高	E1	发声	导通	断路
水温超高	E2	发声	导通	断路
水温超低	E3	发声	导通	断路
室温传感器故障 (恒温无效)	E4	发声	导通	断路
水温传感器故障	E5	发声	导通	断路
冷水机供电中断			导通	断路

注：报警输出端口连接机内继电器一组常开、常闭触点。要求工作电流小于 **5A**，工作电压小于 **300V**。

六、简单故障处理

故障现象	故障原因	处理方法
开机不通电	电源线接触不好	检查电源接口，电源线插头是否接插到位，接触良好
	保险管熔断	打开机器内部的电箱盖，检查保险管，必要时换上备用保险管，并检查电源电压是否稳定，检查电源接口，电源线是否接触良好
流量报警（温控器面板显示 E6）、用水管直接连接出水口、入水口没有水流	储水箱水位过低	检查水位计显示窗，加水到水位显示的绿色区域；并检查水循环管路有无漏水
连接设备使用时流量报警（温控器面板显示 E6）、但用水管直接连接出水口、入水口时有水流，不报警	水循环管路有堵塞或水管折弯变形	检查水循环管路
水温超高报警 (温控器面板显示 E2)	防尘网堵塞，散热不良	定期拆下防尘网清洗
	出风口或入风口通风不良	保证出风口、入风口通风顺畅
	电压严重偏低或者不稳定	改善供电线路或使用稳压器
	温控器参数设置不当	重新设定控制参数或恢复出厂设置
	冷却机频繁开关机	保证冷水机有足够的制冷时间（五分钟以上）
	热负荷超标	降低热负荷，或选用更大制冷量的机型
室温超高报警 (温控器面板显示 E1)	冷水机使用环境温度偏高	改善通风，保证冷水机运行环境在 40 度以下
冷凝水凝结现象严重	水温低于环境温度较多，湿度大	调高水温或给管路保温
换水时排水口排水缓慢	注水口没有打开	打开注水口