



# STEAM **LP**

USER MANUAL  
VERSION 2.0  
OCTOBER 2022



## TABLE OF CONTENTS

Table of Contents	2	Prepare Espresso	28
Copyright Information	3	Steam Milk	29
Welcome	4	Use Hot Water Tap	31
Resources	5	Advanced Menu	32
Warranty Information	6	Adjust Brew Pump Pressure	37
Symbols	7	Adjust Shot Volumes	37
Safety Advisory	7	Adjust Brew Tank Temperatures	38
Water Treatment Requirements	8	Adjust Steam Tank Pressure	38
Recommended Tools & Accessories	9	Adjust Hot Water Dose	39
Installation	10	Adjust Hot Water Temperature	39
<b>PREPARATION &amp; SETUP</b>		Other Menu Actions	40
Step 1: Prepare Site	11	<b>CLEANING &amp; PREVENTATIVE MAINTENANCE</b>	41
Step 2: Unpack Equipment	12	Clean the Machine Exterior	42
Step 3: Connect Plumbing	13	Clean the Steam Wands	42
Step 4: Connect Power	14	General Group Head Care	42
Step 5: Fill Tanks	15	Backflush the Group Head	43
Step 6: Turn On Elements	17	Fast Clean	45
Factory Settings	17		
<b>I'M READY, LET'S BREW THIS!</b>			
Using Slayer Steam LP	17		
Espresso Basics	18		
The Barista Dashboard™	22		



## COPYRIGHT INFORMATION

Copyright © 2020, 2018, 2016 by Seattle Espresso Machine Corporation

All rights reserved. No part of this publication may be reproduced, distributed, or transmitted in any form or by any means without the prior written permission of the publisher, except in the case of noncommercial uses permitted by copyright law. For permission requests, contact the publisher.

**Seattle Espresso Machine Corporation**  
**707 Lind Ave SW**  
**Renton, Washington, USA 98057**

**SLAYERESPRESSO.COM**

## TERMS & CONDITIONS

Slayer makes no representations or warranties with respect to the contents of this publication. Information contained herein is subject to change without notice. Every precaution has been taken in the preparation of this manual; nevertheless, Slayer assumes no responsibility for errors or omissions or any damages resulting from the use of this information.

Read this manual completely before installing and operating your Slayer espresso machine. Incorrect installation and operation may result in damage to the equipment, personal injury, or even death. Disregarding the instructions contained herein indemnifies Slayer from all resulting damages and may void the equipment warranty.

For additional safety precautions, see the safety advisory on page 7.



## WELCOME

Established in 2007, the Slayer catalog of hand crafted machines continues to grow and meet the demands of Slayer users. One of three machines in the new Steam Box Set, Steam LP celebrates what you have come to love in Slayer, exceptional design, durability and consistent results for high volume cafes. When the details matter, this practical, essential rich model is a barflow dream. Professional features that streamline beverage production creating consistency and fluid movement behind a beautifully crafted espresso machine.

Jason Prefontaine founded Slayer when he had an idea for revolutionizing espresso, but that was just the beginning. The Steam series is the result of his continued commitment to Make Coffee Better™. Expanding the Slayer portfolio of professional equipment, we now turn to the milk-dominated world of high-volume coffee business with the same inventive approach that we first took to espresso.

Slayer Steam LP highlights the flexibility of traditional actuation with volumetric accuracy and a mission to give the owner a total value in form and function. Staying true to our mission Slayer realized its potential to design the most intuitive, volumetric machine including special product specific features like programmable pressure profiling (the ability to toggle between two set pressures) to prevent excessive channeling and highlight the character of coffee. The barista dance is elegant, effectively bringing “fun” back to the workflow.

Research and Development is led by Jason Prefontaine and his talented engineers, design by, Chris Flechtner, influenced by the Customer Success team. Steam is the result of a creative collaboration between this dedicated group and many talented friends in the industry. When industry professionals talk, Slayer listens with our most powerful tool being the advise of professional baristas, coffee people and technicians.



## RESOURCES

For quick installation, scan the QR code affixed to your machine's crate. For everything else, contact your authorized Slayer reseller or the appropriate party listed below.

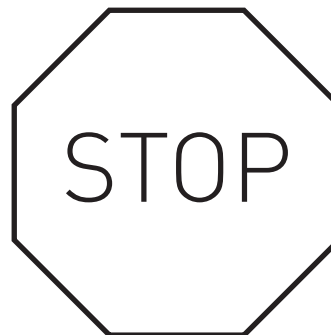

### **SALES**

[sales@slayerespresso.com](mailto:sales@slayerespresso.com)  
+1 (206) 284-7171 EXT. 2

### **MARKETING**

[marketing@slayerespresso.com](mailto:marketing@slayerespresso.com)  
+1 (206) 284-7171 EXT. 6

### **TRAINING & EDUCATION**

[training@slayerespresso.com](mailto:training@slayerespresso.com)  
+1 (206) 284-7171 EXT. 5006

### **TECHNICAL SUPPORT**

[support@slayerespresso.com](mailto:support@slayerespresso.com)  
+1 (206) 284-7171 EXT. 3

### **ORDERS SUPPORT & SPARE PARTS**

[orders@slayerespresso.com](mailto:orders@slayerespresso.com)  
+1 (206) 284-7171 EXT. 2

### **SHIPPING**

[shipping@slayerespresso.com](mailto:shipping@slayerespresso.com)  
+1 (206) 284-7171 EXT. 4



## WARRANTY INFORMATION

Slayer provides a 15-month (fifteen month) warranty on all equipment and parts, beginning at the date of shipment from the Seattle headquarters. All equipment and parts are warranted to be free from defect in material or workmanship. Unless otherwise specified in writing, this warranty covers materials only (e.g. equipment, parts) and excludes labor, shipping, and any other costs.

This warranty does not cover accidental damage to equipment, abuse of equipment, or improper use of equipment. "Improper use" includes, but is not limited to, the operation of a machine with inadequately treated water and/or the operation of a machine with inadequate water supply. Any and all damage resulting from inadequate water treatment is expressly excluded from the coverage of this warranty. Read "Water Treatment Requirements" on pg. 8 for information about water-related issues.

Damage resulting from improper installation of equipment is expressly excluded from this warranty.

Warranty coverage does not include parts that are subject to normal wear and tear, as determined by Slayer. These include, but are not limited to, shower screens, portafilter gaskets, expansion or anti-suction valves, and Preventative Maintenance parts. Warranty coverage excludes glass or plastic parts.

This warranty will immediately expire if you or a third party performs faulty maintenance, excessive use, or neglect of necessary service. This will include any instances in which, following the occurrence of a defect, you fail to immediately take all suitable measures to limit damage to the equipment and/or fail to provide Slayer with an opportunity to remedy the defect.

Slayer's sole responsibility and liability under the warranty set forth herein is limited to, in Slayer's sole discretion, repair or replacement of defective parts. Unless otherwise specified in writing, this excludes labor, shipping, and any other costs.

To the fullest extent permitted by applicable Washington State (USA) laws, Slayer's warranty set forth herein is limited to the original purchaser of the equipment. Slayer does not, directly or indirectly, offer any warranty to any other person, unless otherwise agreed in writing.

Except as expressly provided herein, all goods are provided to you as they are. Slayer disclaims all representations and warranties, whether expressed or implied, including warranties of title, non-infringement, merchantability, and fitness for a particular purpose.

Warranty claims must be authorized by a Slayer Support representative prior to repair or remedial action.



# Symbols



GENERIC WARNING



WARNING: ELECTRICAL HAZARD



WARNING: TRAPPING HAZARD, TAKE CARE WITH HANDS



WARNING: HOT SURFACE



ENVIRONMENTAL PROTECTION



THESE PAGES OF THE MANUAL ARE FOR THE USE OF THE WORKER OPERATING THE MACHINE



THESE PAGES IN THE MANUAL ARE TO BE USED BY QUALIFIED, AUTHORIZED TECHNICAL STAFF



# Safety Advisory

This guide includes important instructions about safe espresso machine installation, operation, and maintenance. Read this manual completely before installing and operating your Slayer espresso machine. Incorrect installation and operation may result in damage to the equipment, personal injury, or even death. Disregarding the instructions contained herein indemnifies Slayer from all resulting damages and may void the machine's warranty.

Shipping is coordinated by the customer and performed by a third party. Slayer is not responsible for damage incurred during transport. Upon receiving your machine, carefully inspect all packaging, equipment, and accessories for visible damage. Photograph any visible damage to the crate or espresso machine and immediately contact your shipping company representative within seven days of receipt. Comply with shipping company regulations. Do not connect your machine to power, water, or drainage until all issues have been resolved or your Slayer representative or reseller instructs you to do so. Failure to resolve issues before using equipment may result in further damage or injury.

Installation should be performed by qualified personnel only and must comply with all regulations and requirements of the authorities in your area. If guidance is needed to safely install your machine, contact your Slayer representative or reseller.

It is critical that an appropriately-rated and grounded electrical plug is used to supply your machine with power. This is essential for the safe operation and use of the equipment. Contact your Slayer representative or reseller with questions about this requirement. If you are unsure about the safety of the electrical configuration, do not attempt to install your machine.

Your Slayer espresso machine should only be used for the functions it was designed to perform. Using your machine outside of its defined functionality – as it is described in the “Using Slayer” section on pg. 17 of this guide – may be a safety hazard, resulting in property damage, physical injury, or even death, and will immediately void the warranty.

Slayer espresso machines are electrical appliances that should be used in a safe manner appropriate to devices of their kind:

- **Do not** connect your Slayer espresso machine to electrical power through an extension cord. The machine must be directly connected to an appropriately - rated and grounded power source.
- **Do not** position the power cord in walkways or other high-traffic areas.
- Slayer espresso machines are designed only to be used indoors
- **Before performing service on your machine, disconnect the power source and turn off the water feed.**
- Prior to installation, make sure there is a circuit breaker installed

with a distance between the contacts that allows for complete disconnection when there is a category III overload and that provides protection against current leakage equal to 30 mA. The circuit breaker must be installed on the power-supply in compliance with installation rules. If the power-supply is not working properly, the appliance can cause transitory voltage drops. The electrical safety of this appliance is only ensured when it is correctly connected to an efficient earthing system in compliance with the electrical safety laws in force. This fundamental safety requirement must be verified. If in doubt, request that a qualified electrician inspect the system. The manufacturer cannot be held responsible for any damage caused by the lack of an earthing system on the electrical supply.

## PLEASE ALSO OBSERVE THE FOLLOWING RULES FOR INSTALLATION AND OPERATION:

- Room temperature must range between 10° and 32°C (50°F and 90°F)
- Do not install in rooms (kitchens) that are cleaned with jets of water or attempt to clean the machine with jets of water.
- When connected to water mains, only use the supplied parts for installation. If other parts are installed, they must be new (unused pipes and gaskets for the water connection) and they must be permitted for contact with water suitable for human consumption (according to local laws in force).
- The mains water pressure connection should be between a minimum of 300 kPa (3 bar) and a maximum of 500 kPa (5 bar).
- This appliance can be used by children aged from 8 years and above and persons with reduced physical, sensory or mental capabilities or lack of experience and knowledge if they are supervised or given instruction concerning the safe use of the appliance and understand the hazards involved.
- Children must not play with the appliance.
- Cleaning and user maintenance must not be made by children without supervision.
- Use by minors, with or without adult supervision, must not contravene local employment laws.
- Never leave the appliance unattended while it is in use.
- If the appliance is stored in rooms where the temperature can drop below the freezing point, empty the boiler and water circuit tubes.
- Do not expose the appliance to atmospheric agents (rain, sun, and cold).
- **Noise:** assessed acoustic pressure level 70 dB(A) (+/- 1dB).
- If the power-supply cord is damaged, it can only be replaced by qualified and authorized technicians.
- If the machine is used improperly or for purposes other than those described above, it can be a source of danger. The manufacturer will not be held responsible for damages caused by improper use of the appliance.





# WATER TREATMENT REQUIREMENTS

Improper water treatment is the most frequent cause of espresso machine damage. Water is complex and varies significantly between regions, so take great care to test the water quality at your location and adjust as necessary. Employ professional help to evaluate your water and administer treatments.

When evaluating water quality, the two most important factors to consider are calcium carbonate and chloride:

**Calcium Carbonate:** a dissolved mineral that determines the “hardness” or “softness” of water. The desirable range of hardness is 4-5 grains. Over time, calcium carbonate accumulates as a hard substance, called “scale”, and will inhibit the flow of water. Machines subjected to “harder” water (greater than 5 grains) will accumulate scale faster and require maintenance earlier.

**Chloride:** chlorine combined with an electron from a negatively charged ion. There are many types of chlorides, including calcium chloride, magnesium chloride, sodium chloride, etc. Chlorides produce salts that impart a strong taste, which alters the flavor of the espresso. Chlorides also encourage pitting corrosion, which causes damage to the machine. incoming water should have no more than 30ppm chloride content.

Your water filtration company will create a treatment plan based on your water needs. Choose a filtration company that has solutions for addressing issues related to both calcium carbonate and chloride. Common treatment options include Carbon Filtration, Ion Exchange, and Reverse Osmosis:

**Carbon Filtration:** a process by which water passes through the granular activated carbon, which attracts and retains many chemicals in the water that have an unpleasant color, taste or odor. Carbon filtration is necessary for all machines. For water with 4-5 grains of hardness, carbon filtration is likely the only necessary water treatment.

**Ion Exchange:** a process by which water passes through an ion exchange system, where undesirable mineral components are retained and more desirable substances such as sodium are released. An ion exchange system should be used in combination with a carbon filtration system and is especially beneficial for water in the range of 6-9 grains of hardness. This system is relatively inexpensive and effective in removing inorganic substances. It does not, however, remove organic substances, such as bacteria.

**Reverse Osmosis with a Blend-Back Valve (or Remineralized RO):** a process by which water is forced through a semipermeable membrane with selective pore sizes at high pressure, then blended with the appropriate amount of desired minerals. Reverse osmosis may be a good solution for water in the range of 6-9 grains of hardness and is mandatory for water above 9 grains. When blending minerals with the filtered water, target a TDS (total dissolved solids) value of 75-125 ppm. Experiment with various TDS levels to determine what produces your preferred taste.

All Slayer espresso machines need to be connected to a carbon water filter to remove chlorine, sediments, odor, and undesirable tastes. This requirement is in addition to any other necessary water filtration systems.

Filtration requirements may vary seasonally. Water should be tested during each season to determine the best filtration plan. Once a filtration method has been selected, take note of the filter’s peak capabilities. Replacement of filtration is based on volume and varying levels of hardness. Contact the filtration provider or vendor to inquire about the life expectancy of the filters, then schedule replacement and installation accordingly.

Slayer’s recommended water recipe for ultimate taste and limited scale:

- pH:** 7-9
- Total Hardness:** 2-6 grains
- TDS:** 50-200 mg/L
- Alkalinity:** 40-100 mg/L
- Chloride:** <30 ppm
- Silica:** <10 ppm
- Chloramine:** <.1 ppm
- Chlorine:** <.1 ppm

- **IMPORTANT: Damage to or failure of your machine due to inadequately**
- **treated water is not covered under warranty. Every time a new water**
- **filter is installed, thoroughly rinse the filter before attaching it to your**
- **machine or pump. Run water from the supply line through the filter**
- **and down a drain for at least 2 minutes, fully washing the filter and the**
- **residue or loose fibers in the filter cartridge. Skipping this step will cause**
- **damage to your machine.**



## RECOMMENDED TOOLS & ACCESSORIES

### BEVERAGE PREPARATION

- Espresso grinder
- Scale (must measure in 0.1-gram increments)
- Tamper (must have a 58-58.4 millimeter base diameter)
- Shot glasses
- Steaming pitcher
- Soft towels

### EQUIPMENT CARE & MAINTENANCE

- Allen keys (Metric and SAE)
- Crescent wrench
- Flat-head screwdriver
- Group head brush
- Needle-nose pliers
- #2 Phillips-head screwdriver
- Pick or awl
- Pliers
- 9/16 inch socket wrench
- Adjustable wrench
- Slayer Espresso Machine Cleaner
- Steam wand cleaner
- Non-abrasive surface cleaner
- Slayer Lubricant
- Teflon tape



**Installation, dismantling, and adjustments must only be performed by qualified and authorized technicians. Carefully read the warnings and rules in this manual because they provide important information regarding safe installation, use and maintenance of the machine. Keep this booklet handy for easy reference.**

## INSTALLATION

Only qualified service personnel should install Slayer espresso machines. For a list of certified Slayer technicians near you please contact our support department. Incorrect installation may result in injury and/or damage to the equipment. Please read the "Safety Advisory" on page 7 before beginning installation.

Install your Slayer espresso machine with the following ordered steps:

<b>Step 1:</b> Prepare Site	11
<b>Step 2:</b> Unpack Equipment	12
<b>Step 3:</b> Connect Plumbing	13
<b>Step 4:</b> Connect Power	14
<b>Step 5:</b> Fill Tanks	15
<b>Step 6:</b> Turn On Elements	16



## STEP 1: PREPARE SITE

Your installation site will require access to power, water, and drainage. Building regulations vary by region, so confirm local requirements before connecting your machine.

Using quality, treated water is essential to achieving the best possible results when preparing coffee and may also extend the life of your machine. Read “Water Treatment Requirements” on page 9 for information about avoiding and addressing water-related issues.

Your Slayer Steam machine needs to be installed on a structure that is capable of supporting its weight, including the weight of the water, once filled:

### • SLAYER STEAM WITH ALL TANKS FILLED

- 2-group 100 kilograms (220 pounds)
- 3-group 140 kilograms (305 pounds)

Use the following diagrams to locate and drill holes in the counter for the power cords and plumbing lines. Note that electrical plugs vary in size and a larger hole may be required to accommodate the main power cord.

- **Optional:** prepare two (2) or more identical block risers, each with a maximum height of 15 centimeters (6 inches) and capable of supporting 140 kilograms (305 pounds). The risers should be designed to elevate the machine approximately 15 centimeters (6 inches) above the counter without touching the drain tray or wing legs. Position the risers on the prepared counter, according to the following diagrams.

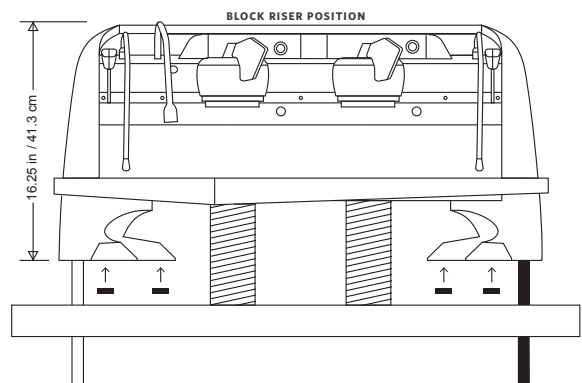
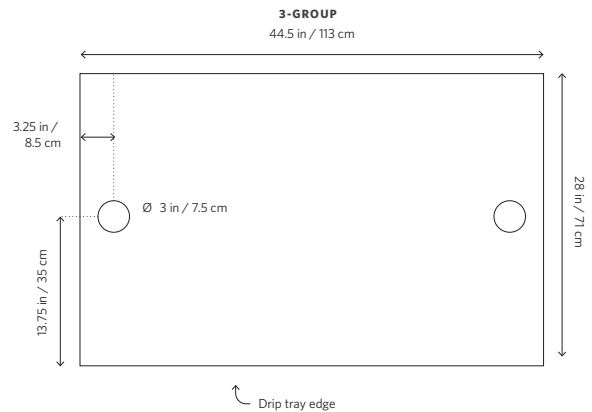
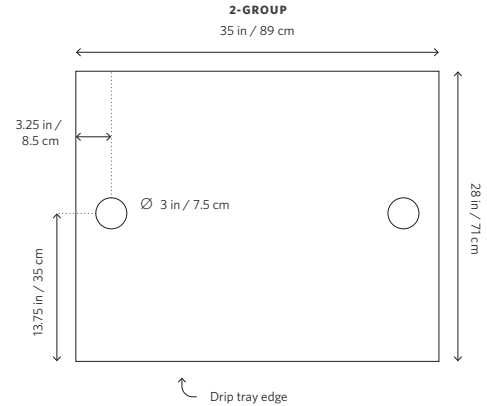



## STEP 2: UNPACK EQUIPMENT

Your Slayer Steam LP machine will arrive in a lidded wooden crate, bolted to a pallet at the base. On the outside of the crate, a Steam QR code will link to a uncrating video which showcases the crate opening procedure. Once the crate is opened, resting atop the machine you will find the accessory box. Unpack with the following steps. At least three (3) ablebodied people will be needed to lift your machine from the pallet. Using a portable lift is recommended.

### REQUIRED TOOLS & SUPPLIES

- Large Flat-head screwdriver or pry bar
- Knife or box cutter
- 9/16-inch socket wrench
- Optional: two (2) or more identical block risers with a maximum height of 15 centimeters (6 inches), capable of supporting 305 pounds (140 kilograms)

### INCLUDED PARTS

- Four (4) rubber feet

### PROCEDURE

1. Use a flat head screw driver or pry bar to remove eight (8) clips located along the lower edge of the crate.
2. Carefully lift the lid from the pallet.
3. Remove the plastic sheet from the machine and identify all crate contents:
  - Slayer Steam espresso machine
  - Attached power cords (2), plumbing lines (2), and drain hoses (2)
  - External rotary pump
  - Accessories box
4. Set aside the accessories box.
5. Locate the two (2) bolts and two (2) nuts that secure the pump to the pallet, then use a wrench to loosen and remove the nuts; set aside the pump.
6. Remove hook and loop strap from the machine body. To protect the machine during installation, keep all other packing material in place.

7. Locate the four (4) bolts that are threaded into the two (2) wing legs, then use a 14mm (9/16-inch) socket wrench to loosen and remove all bolts.
8. Locate the four (4) rubber feet inside of the accessories box and install them on the wing legs. These feet prevent machine slippage and countertop scratches. Later, adjust the feet individually to level the machine
  - **PROTIP:** Place the rubber feet on the Steam prior to lifting to your counter top for final placement.
9. Employ the assistance of at least three people to lift the machine up and away from the crate base, minding the attached cords, lines, and hose.
  - Lift only from the chassis (identified in the image below); do not handle the drain tray, cup rail, or any part of the wing legs. To protect yourself during this step, wear thick gloves or drape a small towel over each wrist and forearm.
10. Suspend the machine with the wing channels located directly above the prepared counter holes. If using risers, lower the machine onto the risers. The risers should support the chassis without touching the drain tray.
11. Remove the packing material from the attached cords, lines, and hoses, then run them through the wing channels and counter holes.
12. Lower the machine into the prepared position and remove all packing material.
13. Remove the cup tray liners and cup tray; set aside.

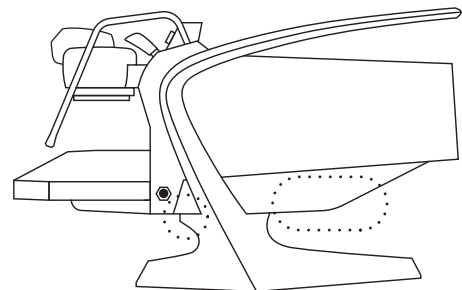



## STEP 3: CONNECT PLUMBING

Your Slayer Steam LP machine will arrive with two (2) plumbing lines and two (2) drain hoses attached. One (1) additional plumbing line will arrive inside of the accessories box. A water treatment system is required, but not included. Read the Safety Advisory for connecting to the water supply on pg. 7 and “Water Treatment Requirements” on pg. 8 for information about avoiding and addressing water-related issues.

### INCLUDED PARTS

- Two (2) drain hoses with an inside diameter of 5/8 inch (16 millimeters)
- One (1) 30 inch 3/8 inch by 3/8 inch BSP braided hose (in North America, includes 3/8-inch adapter for compression fitting)
- Two (2) 60 inch 3/8 inch by 3/8 inch BSP braided hoses, color-coded
- External rotary pump

### REQUIRED TOOLS & SUPPLIES

- Water treatment system (see page 9 for recommendations)
- Pressure Reducing valve or regulator (recommended for flowmeter accuracy)
- Adjustable wrench

### PROCEDURE

1. Install your water treatment system according to the instructions provided by the manufacturer, then turn off the main water supply.
  - Before use, all treatment systems should be flushed with water for at least two (2) minutes.
2. Ensure that the machine is in position, with all cords, lines, and hoses running through the wing channels and counter holes (per previous steps).
3. Run the two (2) drain hoses to an open gravity drain, ensuring that the lines always slope downwards to ensure constant draining of grey water.
4. Locate the 30 inch by 3/8 inch braided hose inside of the accessories box and use it to connect the water treatment system to the external rotary pump, tightening with a wrench.
5. Locate the two (2) color-coded braided hoses, attached to the machine, and the color-coded connections on the pump. Ensure proper connection of low pressure pump outlet (blue) to low pressure machine inlet (blue), and high pressure pump outlet (red) to high pressure machine inlet (red).
6. Connect each hose to its color-matched connection on the pump, tightening with a wrench.
  - Do not turn on the main water supply.

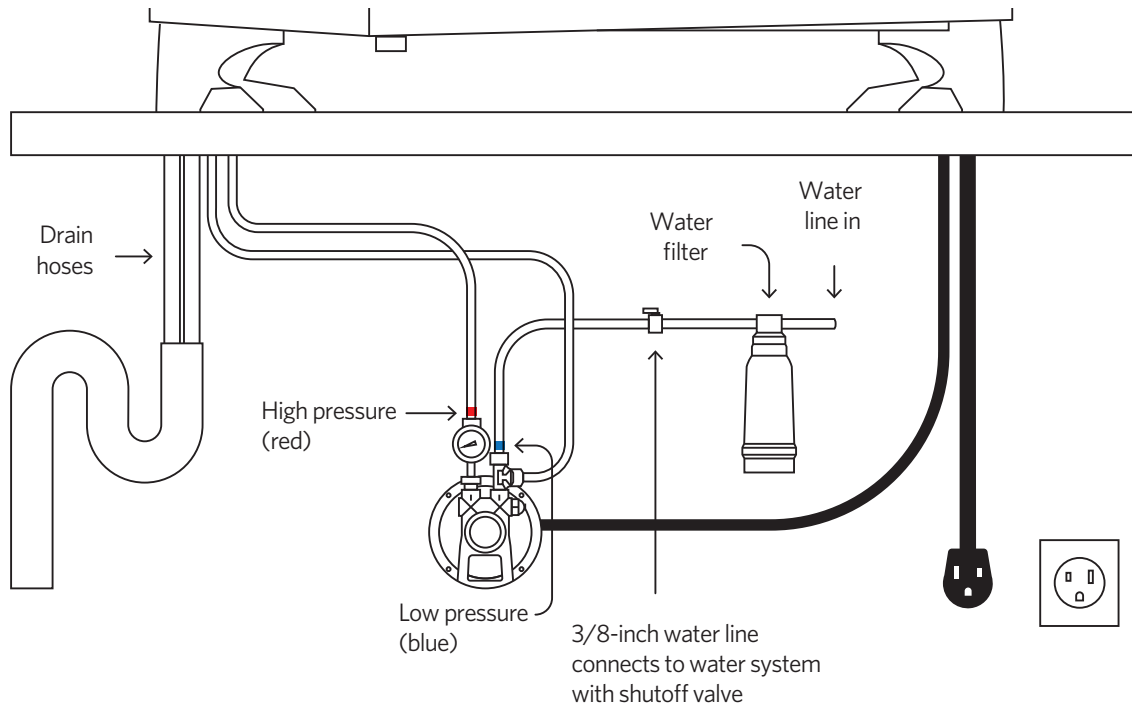



## STEP 4: CONNECT POWER

Your Slayer Steam machine will ship with the power configuration requested at the time of purchase. In most cases, this will include a plug end on the power cord. If your machine does not include a plug, do not attempt to wire it yourself. Only an electrician or approved technician should wire the power cord into an appropriately-rated plug end.

### INCLUDED PARTS

- External rotary pump and motor

### PROCEDURE

1. Ensure that both steam actuators are in the "off" position and the drain hoses and water lines are connected (per previous steps).
2. Insert the main power plug into an appropriately-rated and grounded receptacle
3. Locate the quick connect plug, found on one of the electrical cords that extends from your machine, and insert it into the matching plug unit on the pump motor.

- Do not move the steam actuators to the "on" position. Do not turn on the main water supply.

**NOTE:** UL machines ship capped with a plug end, CE machines DO NOT.

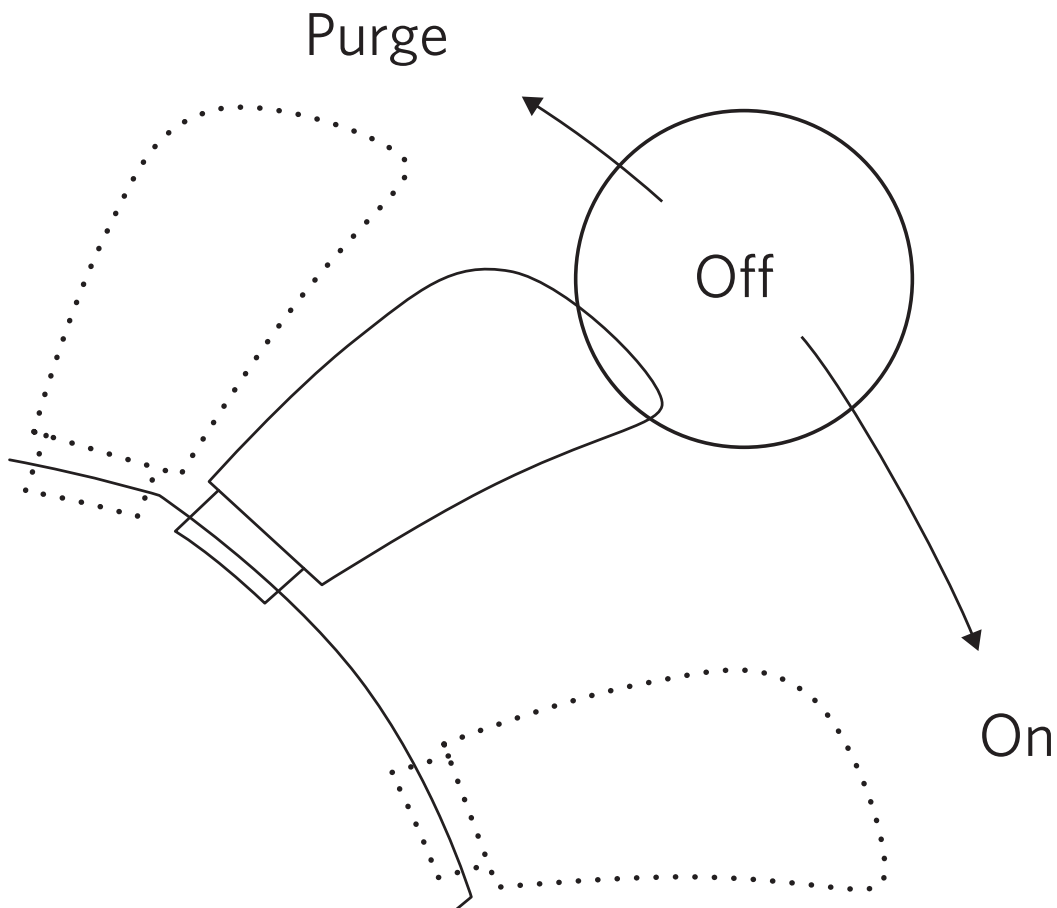



## STEP 5: FILL TANKS

### PROCEDURE

1. Ensure that both steam actuators are in the "Off" position, the drain hoses and water lines are connected, and the cup tray panels have been removed.
2. Turn on the main water supply.
3. Check the inside of the machine for leaks or collected water.
4. Turn on the power to your machine by pressing the power rocker switch; the steam tank will begin to fill.
  - Filling will take 3-4 minutes and is complete when the "↑" symbol disappears from the display and the Steam Fill solenoid clicks shut.
5. Wait until the steam tank has filled completely, then fill the group heads by shifting each group actuator paddle from right to left until water begins to flow.
  - Factory settings for the volumetrics are set (reference Factory Settings on pg. 21). A press of the Manual Mode Button will allow the groups to run continuously up to 180 sec.
6. Move the paddle back to the right to stop the flow of water through the group.
  - Do not move the steam actuators to the "on" position. Do not engage the white heating element breaker.

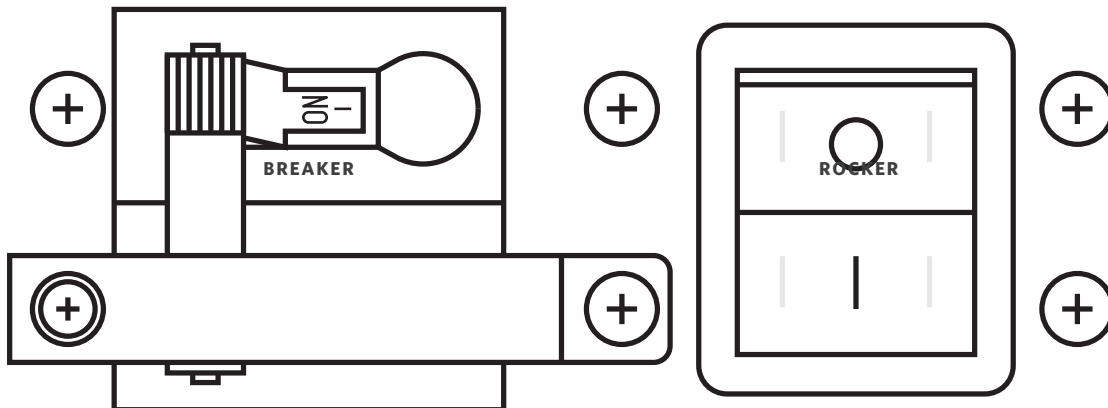





## STEP 6: TURN ON ELEMENTS

### PROCEDURE

7. Ensure that all brew actuator paddles are “OFF” (to the right), the cup tray panels have been removed, and the tanks have filled completely (per previous steps)
8. Turn on the heating elements by moving the heating element BREAKER to the left, the “on” position.
  - Do not move the steam actuators to the “on” position as the machine will automatically cycle the valves during initial heat up.
9. Wait until the machine has heated fully and the pressure reads 1+ bars on the Barista Dashboard, then move one of the steam actuators down, to the “On” position. If steam is produced, proceed to the next step. If no steam is produced, turn the main power On and Off; wait several minutes before repeating this step.
10. Check the inside of the machine for leaks or collected water.
  - The anti-suction valve on the steam tank may sputter and release small drops of water when first building pressure. During your inspection, check for large pools or steady streams of water.
11. Install the cup tray.

## SLAYER STEAM FACTORY SETTINGS

### SLAYER STEAM FACTORY SETTINGS

<b>Brew Tank Temperature</b>	93° C (200° F)
<b>Brew Pump Pressure</b>	9 bar
<b>Steam Tank Pressure</b>	1.4 bar
<b>Low Pressure Regulator</b>	2.5 bar
<b>Shot 1: Pre-Infusion / Brew / Post</b>	1 sec / 30 g / 5 g
<b>Shot 1: Pre-Infusion / Brew / Post</b>	2 sec / 60 g / 5 g



# Using Slayer Steam

Your new machine features sophisticated technologies that are designed to improve numerous aspects of coffee beverage production. These innovations will promote efficiency, accuracy, and comfort on every bar where Slayer Steam LP is found. Whether this is your first espresso machine or the latest in a long career, our instructions should serve as a helpful baseline for getting the most out of Steam LP.

We can't wait to see what you do with it.

## CONTENTS

Espresso Basics	18	Prepare Espresso	28
Slayer Steam LP Factory Settings	21	Prepare Milk	29
The Barista Dashboard™	22	Machine Calibrations	30
Adjust Brew Parameters	22	Brew Pressure and Temperature, Hot Water Temperature	30
Adjust Brew Tank Temperature	26	Hot Water Tap Dosing, Steam Pressure, Shot Counts	31
Adjust Steam Tank Pressure	26	Shot Weight Offsets	32
Adjust Hot Water Dose	26	Advanced Menu: Password Protected Option	33
Automatic and Manual Operation	27		



## ESPRESSO BASICS

Coffee “beans” are the seeds from berry-like fruits that grow on shrubs in equatorial regions. After picking and processing, the beans are roasted, ground, and dissolved in water to yield a coffee beverage.

Brewing espresso is a unique method of coffee extraction in which water is added to ground coffee under intense pressure. As a result, the beverage, when compared to filter coffee (e.g. pour-over, immersion), contains a higher concentration of dissolved coffee, feels heavier in the mouth, and asserts stronger flavor.

The espresso machine is the preferred equipment for preparing espresso. Therein, coffee is secured, water is heated, pressure is applied, filtration occurs, and the beverage is dispensed. The entire process takes less than one (1) minute.

Many variables affect espresso extraction and therefore require the attention of the barista. Consider the following generalizations and guidelines when preparing espresso.

### COFFEE ORIGIN

Coffee plants are cultivated around the world in equatorial regions that have varying climates and growing conditions. Every location – country, locale, farm, and lot – produces coffee with distinct characteristics that contribute to discernible differences in beverage flavor. Slayer Steam is well-suited for preparing coffee from any single origin, as well as blends of coffees from varying origins.

### PLANT VARIETY

Like other fruits (e.g. apples, oranges), coffee beans may come from one of many varieties of the same plant. Common varieties include Typica, Bourbon, Heirloom, and Caturra, among others. Every variety produces coffee with distinct characteristics that contribute to discernible differences in beverage flavor.

### PROCESSING METHOD

There are many unique processes by which coffee seeds may be separated from the fruit containing them. Every process produces coffee with distinct characteristics that contribute to discernible differences in beverage flavor. Note these examples:

- **“Washed” process:** increased acidity, enhanced flavor clarity, clean body
- **“Natural” process:** fruit-forward flavor, full body

- **“Pulped natural”, “semi-washed”, and “honey” processes:** borrowed characteristics from washed and natural processes

### GREEN COFFEE FRESHNESS

After it has been picked and processed, green (i.e. un-roasted) coffee has a considerable shelf life. However, the potential quality of coffee beverages deteriorates with the age of the green coffee. For best results, buy roasted coffee from a trustworthy supplier that guarantees the freshness of its green coffee.

### ROAST PROFILE

Roasting makes the dense, green coffee bean porous and soluble and is the first step in preparing coffee for extraction. Coffee may be roasted to varying degrees by a variety of technologies, each producing coffee with distinct characteristics that contribute to discernible differences in beverage flavor.

Generally, the flavor of espresso prepared from light-roasted coffee will more closely resemble the characteristics of its origin, variety, and processing method (e.g. “bright”, “fruity”, etc.). Conversely, the flavor of espresso prepared from dark-roasted coffee will more closely resemble the characteristics of caramel, dark chocolate and nutty flavors. In some instances the dark roasting process will take a coffee too far into the roast yielding over developed flavors. (e.g. “smoky”).

### ROASTED COFFEE FRESHNESS

After roasting, coffee beans are increasingly vulnerable to deterioration. Preserve freshness by storing in a sealed container in a cool, dark area. Ideally, use a container that allows the outward flow of gas, which coffee releases as it ages, but prevents the inward flow of oxygen. Espresso is generally most flavorful when prepared with coffee that has “rested” for at least two (2) days after roasting but has not exceeded three (3) weeks. These guidelines are especially important for dark- roasted coffee, which deteriorates faster than light-roasted coffee.

### GROUND PARTICLE SIZE

Preparing espresso requires finely-ground coffee and a professional grinder. When setting up your grinder, target a setting that achieves the recommended beverage yield with the recommended dose weight in the recommended brew time. Continue reading for recommendations



regarding these brewing parameters. Adjust grind as necessary, noting these rules:

**Finer grind setting** (smaller particles):

- Longer extraction time
- Enhanced body
- Reduced clarity
  - ⋮ Recommended when espresso tastes sour, feels thin, extracts quickly, or has no crema.

**Coarser grind setting** (larger particles):

- Shorter extraction time
- Reduced body
- Enhanced clarity
  - ⋮ Recommended when espresso tastes bitter, feels muddy, or extracts slowly.

**DOSE WEIGHT**

Dose weight refers to the amount of ground coffee used for a serving of espresso. When considered alongside the beverage yield, dose weight is part of the brew ratio, which correlates with the perceived strength of the espresso and influences the extraction process. Slayer recommends using a scale to measure 18-21 grams of ground coffee per espresso serving. Begin with 18 grams, then adjust dose weight as necessary, noting these rules:

**Larger coffee dose** (more weight):

- Increased flavor intensity
- Longer extraction time
  - ⋮ Recommended when espresso tastes sour, feels thin, extracts quickly, or has no crema.

**Smaller coffee dose** (less weight):

- Decreased flavor intensity
- Shorter extraction time
  - ⋮ Recommended when espresso tastes bitter, feels muddy, or extracts slowly.

**For larger doses, please contact Slayer regarding details on larger baskets for you how like to brew.**

**BED DEPTH**

Distribution and tamping ground coffee is essential to forming a puck through which water will evenly flow. Use logic when dosing and distributing to create an even pre-tamp bed. Instead of tamping to a specific pressure (e.g., 30 pounds), Slayer recommends tamping to a specific depth in order to achieve the adequate headspace between the coffee puck and the shower screen. To ensure consistent results, target a tamp depth that levels the top of the tamper piston with the top of the portafilter basket (approximately 1 centimeter).

**WATER TEMPERATURE**

At the factory, the brew tank temperature is set to 93° C (200° F). Coffee is best brewed with water heated to 92-95° C (195-205° F).

If you do not know which temperature to set your machine at begin with the factory setting, then adjust the temperature as necessary, noting these rules:

**Higher temperature:**

- Increased extraction rate
- Enhanced acidity
  - ⋮ Recommended when espresso tastes sour.

**Lower temperature:**

- Decreased extraction rate
- Reduced acidity
  - ⋮ Recommended when espresso tastes bitter.

**To adjust the brew temperature, see instructions under Using Slayer > Adjust Brew Temperature on page 28.**

**WATER PRESSURE**

At the factory, the brew pump pressure is set to 9 bar. Generally, espresso is best brewed with water pressurized to 6-10 bar. More dense coffees (such as those grown at a higher elevation, processed with the “washed” method, and/or roasted light) may endure higher pressure, while less dense coffees (such as those grown at a lower elevation, processed with the “natural” method, and/or roasted medium- to-dark) prefer lower pressure.

**To adjust the brew pump pressure, see instructions under “Using Slayer > Adjust Brew Pump Pressure” on page 30.**



## BEVERAGE YIELD

Beverage yield refers to the weight or volume of a serving of espresso. When considered alongside the dose weight, beverage yield is part of the recipe often referred to as the brew ratio, which correlates with the perceived strength of the espresso (sweetness, acidity, body) and influences the extraction process. No one knows your coffee better than your roaster and in some cases you are still the best maestro for conducting great cup experiences. As a baseline Slayer recommends using a scale or graduated shot glasses to measure 25-40 grams or 1.0-1.5 fluid ounces of espresso per serving. Begin with 35 grams or 1.25 fluid ounces, then adjust beverage yield as necessary, noting these rules:

### **Larger yield** (more weight or volume):

- Decreased flavor intensity
- Longer extraction time
  - ⋮ Recommended when espresso lacks clarity.

### **Smaller yield** (less weight or volume):

- Increased flavor intensity
- Longer extraction time
  - ⋮ Recommended when espresso lacks body.

## BREW TIME

Brew time refers to the total duration of extraction. Begin with 25 seconds, then adjust brew time as necessary, noting these rules:

### **Longer brew time:**

- Higher extraction yield
  - ⋮ Recommended when espresso tastes sour.

### **Shorter brew time:**

- Lower extraction yield
  - ⋮ Recommended when espresso tastes bitter.



# Installation Check-up

 **Warning: after installation, check to see if the machine is working properly**

## WATER CONNECTIONS

- No leaks from the connections or tubes

## FUNCTIONING

- Boiler and operating pressures are normal.
- The pressure gauge is working properly.
- The expansion valves are working properly

 **Warning: once the machine has been installed and is ready for use, before allowing the worker to start using the machine, wash the internal components according to the instructions below:**

## GROUPS

- Install the portafilters in the groups (without coffee).
- Let each group dispense water for about a minute.

## HOT WATER

- Continuously dispense hot water until at least 3 liters of water have been dispensed
- See the “Hot water dispensing” chapter in the User’s Manual.

## STEAM

- Dispense steam from the nozzles for about a minute.



## THE BARISTA DASHBOARD™

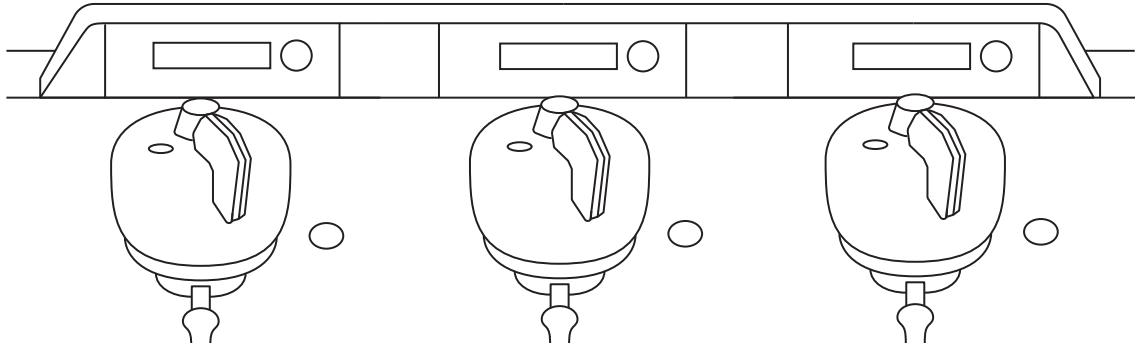

Slayer Steam LP is equipped with a digital interface that displays the essential functions of the machine up front and center for your ease. Through the Barista Dashboard™, you have access to quick and effective brewing parameters and the ability to access two layers of password protected menus as a Manager or Technician. \*\*Password protection is disabled from the factory for ease of install and out of the box calibration and programming.

### BASICS OF NAVIGATION

- The menu, settings, and query display is centered within the Barista Dashboard™
- An easy to use menu button is located to the right of each heads up barista dashboard. The far left (Group1) is the master grouphead where all program options are available. This is used to enter the menus, cycle options, make selections, and adjust settings. These actions are accomplished in two different ways
  - Scrolling from the home screen gives access to the Barista Menu showcasing Brew Parameters, Shot Counts (per group), a prompt to Enter the Menu (if passwords are not yet set), Full Cleaning, Quick Cleaning & Switch Off
  - Pressing the Menu button from the home screen quickly jumps to the Enter Menu Screen
- A short hold (2 seconds) will exit from a setting within any of the three menus, while a long hold (5 seconds) will revert to the Home menu. A timeout will occur after 30 seconds, sending the user back to the home menu.
  - **PROTIP:** Moving the actuator on and off will exit any menu and cancel any changes. (Think of it as an escape button).
- If saving a volumetric or temperature setting on the left (master) group head, when prompted, scroll to select ALL to save details across multiple groups or select Gp1 to save details at each individual group.

- Scroll to the next menu adjustment until setup is complete.
- The menu layout is circular; after cycling through the end of the menu options, the first menu option will reappear.

### SETTING PASSWORD

Password protection is disabled upon arrival to ensure fluid installation and setup and all menu options in the Advanced Menu are available. Once the initial options have all been set, the owner/operator may enable passwords for the Manager and Advanced menus.

When password protection is enabled, the user must enter the Manager password to access the Manager Menu and the Advanced Password to access the Advanced Menu.

- **PROTIP:** There is no separate prompt for which password to enter;
- entering a correct password will take you to its matching Menu.

Details on how to set the Manager and Advanced Passwords are outlined below.

A password can be between 1-8 characters, A-Z letters (uppercase only) and 0-9. Using the blank space or Null <> will indicate the password is completed.

#### Set Passwords, Manager & Advanced Menus

1. Scroll to PASSWORDS
2. Scroll to select <ENABLE> and press the menu button
3. Scroll to select Manager and enter a password by scrolling to a desired character. Press the menu button to move to the next character. Scroll to the null <> character (one counter-clockwise click past 0) to complete the password.
4. Scroll to select Advanced, and repeat step 3 for the Advanced password.
5. Long press and hold the menu button to save and exit back to the Home screen



- **PROTIP:** Write down the passwords
- Manager \_\_\_\_\_
- Advanced \_\_\_\_\_

**Disable Passwords: Manager & Advanced Menu's**

- **Caution:** Disabling Passwords will allow any user to change settings in the
- Advanced Menu

**To Disable all Passwords:**

1. From the Home menu scroll to the Enter Password prompt
2. Scroll to select <DISABLE> and press the menu button to enter.

**To Disable the Manager Password Only:**

1. From the Home Screen scroll to Enter Password or Menu Prompt and press the menu button.
2. Enter the Password you previously set for the Advanced Menu; from the Advanced Menu scroll to Password and press the button. Select <ENABLE> and then scroll to select <Manager>.
3. Scroll to the first slot for character to the numerical value 0, one more click counterclockwise to a blank space or <null> value between the brackets; Ex. < >
4. Press to select and the password for that menu is now set to null

- **NOTE:** Setting the Advanced password to <null> (off) disables programming a password for the Manager menu.

- **PROTIP:** Hold the button for 2 seconds to go back to the last screen, and 5 seconds to return to the home menu.

The Home Display Menu is rich with real time details on multiple functions within the machine.

- **Heating element activity**, represented by a colon (“:”). When a brew tank is being heated, the colon will flash near the brew temperature reading on the corresponding screen.
- **Steam tank fill status**, represented by an upward-facing arrow. When the steam tank is being filled, the arrow will appear next to the steam tank pressure reading.
- **Brew time** (“Time”) for the previous extraction, displayed in tenthsecond (0.1-second) increments. At the beginning of each extraction, the timer will automatically reset and begin counting up from zero (0). At the end of each extraction, the timer will automatically stop and will remain visible until the next extraction begins. Button activations under 2 seconds will not reset the shot

time, and under 5 second will not count as a shot in the shot counter. This is to allow the barista an opportunity to flush or purge the group after an extraction and still see the value of your previous extraction.

- **Last Shot Weight** (“Wt”) reading, displayed to the nearest tenth of a gram
- **Brew temperature** (“Temp”) reading, displayed in tenth-degree (0.1-degree) increments in Fahrenheit or Celsius.
- **Steam tank pressure** (“Stm”) reading, displayed in 0.1-bar increments

**MENU OPTIONS**

The first level of navigation is the Default Display menu which houses several options for easy access:

1. Default Display: Extraction Time, Shot Weight, Temperature (& Steam Pressure)
2. Quick Change Last Shot Parameters
3. Manual Button Default Parameters
4. (Deeper) Menu Options
5. Shot Counter
6. Group Cleaning-Full Clean
7. Group Cleaning-Quick Clean
8. Switch Off

- **PROTIP:** Scrolling counter clockwise intentionally showcases the Group Cleaning - Quick and Full to encourage cleaning whenever possible.

**Default Display: Group Settings**

**SCREEN EXAMPLE:**

Time	Wt	Temp	Stm
25.2 s	30.6 g	199.0	1.4 ↑

The last espresso brew shot time and weight is noted on the left half of the screen. Group Temperature is displayed on the right side and Steam Pressure is displayed on the far right of the Group 1 screen only. Note that the shot timer does not reset unless it runs for longer than two seconds. This allows the barista to purge the group of residue and not lose sight of the previous shot time.





### Quick Change Last Shot Parameters

SCREEN EXAMPLE:

Pre	Brew	Post
< 0 . 0 > s	6 0 . 0 g	5 . 0 g

To quickly adjust the Pre-Infusion, Brew and Post-Infusion parameters of the last saved shot, scroll to Quick Change Last Shot Menu and depress the Menu button. Here Pre-Infusion is adjusted in tenths of a second, and Brew and Post-Infusion can be adjusted in 0.5 gram increments. When the bracket prompt "< ... >" appears around the value, press the button to accept or scroll to a new value and press to accept. This will advance the prompt. When all three parameters have been accepted, the shot is saved for that particular group in the same paddle position that was used for the previously programmed shot.

### Manual Button Default

Please see the Section on Manual Operation on pg. 27

### Shots Dispensed Per Group

A shot count is recorded every time a button remains in use longer than five seconds. To view the number of times a shot has been extracted, use the following steps.

SCREEN EXAMPLE:

Shot Counter	15
--------------	----

1. From Group 1 Dashboard, scroll to Shot Counter and depress the button to enter the menu.
2. The screen will display the number of Shots recorded at Group1 for Shot 1, Shot 2, and Manual mode shots.
3. Scrolling through will display the records for the other groups, the Hot Water button count and the left & right Steam Wand.

- Note that groups 2 and 3 will only display counts for their
- respective groups.

### Enter Password

Please see the Section on Passwords on pg. 22.

### Automated Backflush/Cleaning

Backflush cleaning can be done with or without cleaner to ensure quality of taste throughout the day and especially at the end of each day. Follow the steps below to clean the group head of coffee oils and residue.

SCREEN EXAMPLE:

Full	Cleaning
< ALL >	

#### For Full Clean:

1. Remove the dispersion screw and screen from the group head AND the basket from the portafilter.
2. Place all three parts in a solution bath of Slayer Espresso Machine Cleaner and hot water. Follow the recipe on the container for best results.
3. This cycle is done with the blind basket in place of the standard brew basket and the proper amount of cleaner dissolved slightly in hot water to activate without issue
4. Place the portafilter in the group head
5. Scroll to **Full Clean**
6. Select to clean ALL groups and depress or Gp 1, Gp 2 and so forth to backflush groups individually.
7. When Full Cleaning cycle is selected in the menu a 100 second rinse and soak is activated. The pattern is ON (water flows into the group) for seven seconds and OFF (water stops flowing) for 3 seconds allowing for a hold time. The sequence repeats 10 times.
8. Once the cycle is complete the screen will prompt, "**Remove Portafilter. Click for Flush**"
9. Remove and depress the menu button to run the 30 second countdown and flushing cycle.
10. Using the blind basket and portafilter combination again, run a full cycle clean **WITHOUT** cleaner to remove any potentially undissolved Slayer Cleaner.
11. Repeat steps 8 and 9.

Once complete the screen will default to the Home menu.

- Slayer Espresso Machine Cleaner is a food safe product, however, when
- residue is left behind it will impart a soapy flavor and odd aromatics unless
- completely rinsed away.



## Quick Cleaning

SCREEN EXAMPLE:

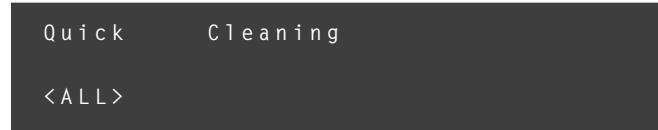

Quick Cleaning option is designed to give you access to a non-detergent cleaning cycle, performed after a busy rush or at a shift change. This cycle is done with the blind basket in place of the standard brew basket with **NO cleaner added**. The Quick Cleaning process is a 12 second cycle, ON for 3 seconds, OFF for 1 second. It repeats itself three times.

1. Leave the dispersion screen and screw in place.
2. Replace the brew basket with a blind basket in the portafilter.
3. Scroll to Quick Clean.
4. Select to clean ALL groups and depress for Gp 1, Gp 2 and so forth to backflush groups individually. Selecting <No> will cancel the clean.
5. Once the clean is complete it will auto reset back to the Home menu.
6. Replace the blind basket with a clean brew basket.

## ON/OFF From the Barista Dashboard™

Turning off the machine can be done through the heads up Barista Dashboard™.

SCREEN EXAMPLE:



1. Scroll to Switch Off.
2. Depress the menu button to enter the option.
3. Scroll to select <Yes>.
4. Press the Menu Button to turn the espresso machine back on.

## Screen Display Example: OFF

SCREEN EXAMPLE:

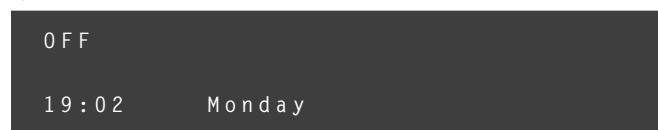

## MANAGER MENU, Password Protected Option

The second level menu Manager Menu can be password protected. To access the menu with the stock password, scroll to Enter Password, depress the button which prompts you to enter the password. If this is your first time using the machine and passwords have not been set, the factory password is "null" and can be accessed by simply clicking the button again.

### Manager Menu Options:

1. Service Notification
2. Brew Parameter Adjustments
3. Brew Group Temperature
4. Hot Water Tap Program Dose
5. Steam Boiler Pressure
6. Totals Reset
7. Auto-Flushing
8. Calibrate Shot Weight Offset

SCREEN EXAMPLE:

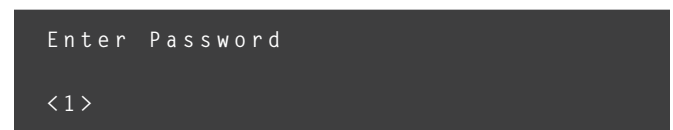

1. Scroll to Manager Menu
2. Select <Null>

• **NOTE:** To reset the password for both Manager and Advanced Menu's see the instructions on page 23. Scroll clockwise through the menu to see options.

## Service Notification

This is an informational screen which represents the time left before the next scheduled Preventative Maintenance (PM) service is due. This notification will decrease by one month every 30 days. If the services needed for the machine have not been performed within one year of ownership and the service counter has not been reset, the number will start counting in negative months. Service is now overdue.

SCREEN EXAMPLE:



To reset the machines service notification after a Preventative Maintenance repair has been completed, reference pg. 35 in this manual.



## Brew Parameter Adjustments

The Slayer Steam LP has options for two programmable volumetric settings per group.

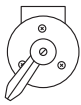

This is the paddle position for parameters saved as "Shot 2"

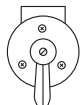

This is the paddle position for parameters saved as "Shot 1"

Steam LP also has multiple settings available for adjustment per shot.

These are:

- Pre-Infusion time, tunable in tenth of a second (0.1s) increments
- Brew Weight, tunable in half-gram (0.5g) increments
- Post-Infusion Weight, tunable in half-gram (0.5g) increments

To Program Shot 1, follow the steps below.

1. From the Manager Menu, scroll to Brew Parameters and press the button to select.
2. Select <Shot1> and press the menu button to advance.
3. For the Group parameter, select the option <Group1> or scroll to <All> to save the Shot 1 profile to all groups. Depress the menu button to accept.

SCREEN EXAMPLE:

Position	Group
<Shot 1>	Gp 1

4. The settings for each phase of the shot profile - Pre, Brew, and Post - are now displayed and ready for adjustment. Press the menu button to accept the displayed value or scroll to adjust. Pressing the menu button advances the prompt. Once all three settings have been accepted, the shot is saved as Shot1 for that group (and to All groups if previously selected).

SCREEN EXAMPLE:

Pre	Brew	Post
<0.0>s	30.0g	0.0g

5. The screen will revert to the Manager Menu Options
6. The process can be repeated for Shot 2 on Group1 and for each Shot position on Group 2 and Group 3.

- **NOTE:** If there is a 1-3 gram difference in the final output of your group heads volumetrics and proper technique has been used for dialing in a shot (ie; using a scale and an exacting coffee recipe), verify the machine flowmeters are calibrated. For a step by step guide toward calibrating your flowmeters for optimum consistency, turn to pg. 32.

## Brew Group Temperature

Brew tank temperatures are measured in real-time at each group head and displayed in degrees Fahrenheit or Celsius, depending on saved preference. Adjustable in tenth-degree (0.1-degree) increments

- 82° C (180° F) Minimum to 97° C (206° F) Maximum

SCREEN EXAMPLE:

Temperature
<201.0>F

1. Working from the left group will enables the ability to copy the temperature to all groups.
2. **Copy all Groups <YES >** prompt will only occur when programming values with the Master (Left) group. By selecting NO, proceed by individually programming brew group temperatures as desired.
3. Exit the menu when programming is completed across all groups

## Hot-Water Tap, Steam Boiler Pressure and Reset Counters

Please see the sections in Machine Calibrations (pg 31)

## Auto-Flushing

Steam LP features an Auto Flush that enables a quick purge of the group after each shot for a programmable time period between zero and five seconds. This feature can also be set to <Off>

From the Manager Menu, scroll to Auto Flush, and depress the menu button to select.

SCREEN EXAMPLE:

Auto Flushing
<Auto+Man> 5.0s

The mode selection options are Auto, Manual, Auto + Manual, and Off.

If Auto is selected, the group will flush for the pre-set time whenever the paddle is moved back to the home position after a completed shot. This setting is operable when the Steam LP is making shots in Automatic Mode

If Manual is selected, the flush function is only activated when the paddle is rapidly moved away from and returned to the home position. The duration of the move needs to complete in less 0.5 seconds to activate the flush.

When Auto+Man is selected, the group will autoflush for the set amount of time using either of the above methods.



## AUTOMATIC AND MANUAL OPERATION

Slayer Steam LP allows the barista to operate in two separate but related modes: Automatic and Manual.

In automatic mode, the barista may dispense a pre-programmed shot using the paddle positions denoting Shot1 and Shot2. This is possible at each group, and each shot is customizable as described in the brew parameters section (on pg. 26).

### Manual Mode

Steam LP also lets the Barista switch to Manual Mode with the touch of a button.

- Using manual mode is recommended for dialing in a new coffee recipe
- It is also useful when incorporating an additional grinder for a special coffee or decaf that is not used in the automatic shot profiles.

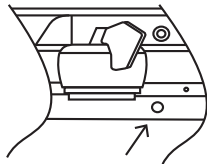

When in manual mode, the “M” symbol will appear in the upper right corner of the Barista Dashboard™. The Group will now behave like a manual machine:

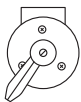

With the paddle in Position 2, the group will be in full pressure brewing

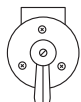

With the paddle in Position 1, low-pressure pre-infusion (or Post-Infusion) will be active

Steam LP also enables a Manual shot to be saved as Shot 1 or Shot 2 in Automatic Mode. Below is the recommended procedure to save shots using Manual mode

1. Press the Manual Mode button on the lower front panel

#### SCREEN EXAMPLE:

Pre	Brew	Post	M
0.0s	60.0g	5.0g	

2. Move the paddle to position 1 to begin the Pre-Infusion and Brew timers
3. Move the paddle to Position 2 and this will shift from low to high pressure.
4. For Post-Infusion, move the paddle back to Position 1 to shift to low pressure and the Post Brew timer will begin

5. To complete the shot move the paddle back to the home position.
6. Continue pulling shots until a profile is desired to be saved.
7. Press the Manual Mode button again. This will allow the shot to be saved. The screen below will appear
  - **NOTE:** If Passwords are enabled, the correct Password will need to be entered before a Manual shot can be saved.

#### SCREEN EXAMPLE:

Save	Last	Shot	
<No>	SH1	SH2	Ca1Wt

8. Scroll to SH1 or SH2 to save the last shot at that respective paddle position. Press the Menu button to accept.
9. The screen will prompt whether to Copy that shot to All groups. Choose <Yes> or <No>. The screen will return to the home menu.

### Manual Button Default

In the Home Menu, scroll to Manual Button Default and press the button to enter the Menu.

#### SCREEN EXAMPLE:

Manual Button
Default: <Shot1>

If Shot 1 is selected, any press of the Manual Mode button will display the following screen and the manual shot will be able to be saved directly to Shot 1.

#### SCREEN EXAMPLE:

Save Last Shot
<No> Yes All Ca1Wt

When the Manual Button is set to Shot1 or Shot2, a “1” or “2” character will appear in the upper right corner of the screen and the Display will appear in the following format:

#### SCREEN EXAMPLE:

Time	Post	Wt
0 0s	0.0g	0.0g

The number to the left of the separator “|” under Time represents Pre-Infusion time, the number to the right of the separator represents total Brew time. Post-Infusion and Shot Weight are displayed in grams.



## PREPARE ESPRESSO

Slayer Steam LP utilizes a variable extraction method to produce espresso in a system with custom gicleurs, precision screens and tunable volumetrics.

The following steps represent a good starting point when first using Slayer Steam LP to prepare espresso.

### INCLUDED PARTS

- Portafilter

### RECOMMENDED SUPPLIES & EQUIPMENT

- Soft, clean towel
- Espresso grinder
- Espresso tamper
- Large portafilter scale
- ⋮ See complete list on page 10.

### PROCEDURE

The following steps represent a good starting point when first using Slayer Steam to prepare espresso.

1. Remove the portafilter from the group head and wipe the basket with a dry towel.
2. Set the grinder to a degree of coarseness suitable for brewing espresso, a fine powder without clumps.
3. Grind and dose 18—21 grams of coffee into the portafilter.
4. Tamp until the top of the tamper base is level with the rim of the portafilter basket, leaving approximately 1 centimeter of empty space above the puck.
5. Set aside the portafilter while you flush the group head and lock the portafilter into the group head.
6. Position a shot glass directly under the portafilter.
  - ⋮ The hole pattern on the drain tray indicates a location that is centered under the portafilter.
7. Press the Manual Mode button and Move the paddle to Position 1 (if pre-infusion is desired) or to Position 2 to begin a classic “9-bar” extraction.
8. Allow the espresso to brew until the preferred extraction has been achieved (when the desired beverage yield has dispensed, or when the desired brew time has elapsed), then depress the button off if using Manual.
  - ⋮ If using volumetric settings, verify results with a scale and calibrate grind size, water volume and temperature accordingly.
9. Pressing the Manual Mode button again will give you the option to save the shot profile, copy to all groups as well as calibrate the Shot Weights.
  - ⋮ See the section on Machine Calibrations on pg. 30 for more details on Shot Weight calibration
10. Remove the portafilter from the group head and discard the puck, then wipe the portafilter with a towel to remove grounds and oil.
11. Flush the group head to purge grounds and oil, then return the portafilter to the group head.
  - ⋮ **PRO TIP:** To enable an Auto Flush feature turn to pg. 26.



## STEAM MILK

Slayer Steam LP utilizes a dedicated Steam Boiler with adjustable Steam pressure. The steam actuators allow for three (3) positions: “off”, “on”, and “purge”.

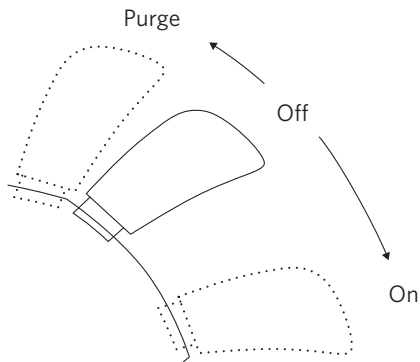

The following steps represent a good starting point when first using Slayer Steam to prepare milk.

### RECOMMENDED SUPPLIES & EQUIPMENT

- Cold steaming pitcher
- Soft, clean towel
- See complete list on page 10.

### PROCEDURE

1. Fill a pitcher with the desired volume of fresh, cold milk.
2. Aim the steam wand toward the drain tray or into a towel and briefly move the steam actuator up to the “purge” position to release steam and condensation.
3. Submerge the steam tip in milk and move the actuator down to lock it into the On position.
4. Move the pitcher down to expose the steam tip to the surface of the milk, incorporating fine air bubbles.
5. Submerge the steam tip when the milk reaches body temperature
6. Tilt the pitcher to form a whirlpool and evenly disperse microfoam throughout the pitcher.
7. Turn off the steam wand when the pitcher feels hot to the touch. The final milk temperature should be 55—65° C (130—150° F).
8. Wipe the steam wand with a damp cloth, removing all milk residue, then purge again to remove any milk residue inside the wand.



**Scalding hazard! Use the appropriate insulating devices to move the water and steam nozzles.**



# MACHINE CALIBRATIONS

## ADJUST BREW PUMP PRESSURE

- **PROTIP:** With a blind basket portafilter in a group, set the pump pressure 1 bar above the desired extraction pressure.

### REQUIRED TOOLS

- Slot screw driver
- Small crescent wrench

### PROCEDURE

1. Locate the pressure gauge and adjustment screw on the external rotary pump.
2. Loosen lock nut on pump screw.
3. Move the brew actuator to the on position.
4. Turn screw clockwise to increase the pump pressure. Turn counterclockwise to decrease the pump pressure.
5. Tighten lock nut to hold setting.
6. Return the brew actuator to the off position and tighten the lock nut.

## ADJUST HOT WATER TEMPERATURE

Slayer Steam features a blending valve that draws water from the steam tank and main cold water line simultaneously. Custom water temperatures are configured with the blending valve. Adjust the hot water temperature with the following steps.

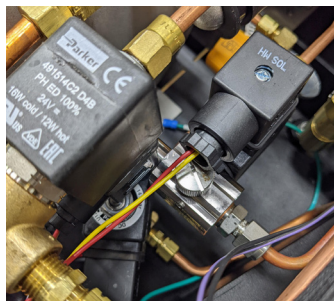

### REQUIRED TOOLS

- Phillips Head Screwdriver
- Flat Head Screwdriver

### PROCEDURE

1. Remove the side panel on the left side of the machine by removing two phillips screws or remove the cup tray. Locate the blending valve near the steam solenoid valve. [see photo above]
2. Adjust the hot water temperature:
  - Clockwise rotations increase the hot water temperature.
  - Counterclockwise rotations decrease the hot water temperature.

3. Verify the temperature at the hot water tap with a digital thermometer.

## ADJUST PRE-INFUSION PRESSURE

Machines are tested at 2.5 bar (~36psi). Recommended operating pressure is between 2.5 and 4 bar (~ 36 to 60 psi).

### REQUIRED TOOLS

- Slot screw driver
- Small crescent wrench
- Phillips Head screw driver

### PROCEDURE

1. Remove the Cup Tray Covers and Cup Tray. It may help to remove the left side panel by removing two Phillips screws.
2. Locate the Pre-Infusion pressure regulator
3. Loosen locknut on the regulator.
4. Turn screw clockwise to increase the pump pressure. Turn counterclockwise to decrease the pump pressure.
5. Tighten lock nut to hold setting.
6. Replace Cup Tray and Cup Tray covers or when maintenance is complete.

- **Note:** For best results, it is suggested to keep the regulated line pressure at or above 2.5 bar.

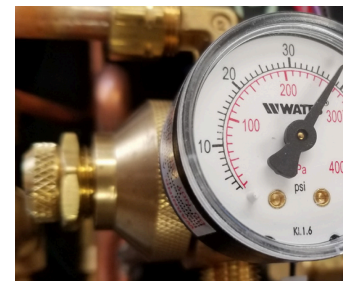



### ADJUST HOT WATER TAP FUNCTION

Dispense hot water by pressing the button to the right of the tap. The flow of water will stop automatically, after the pre-configured volume has been dispensed. To adjust the hot water tap volume use the instructions detailed below. The range of setting is available from 0.0 to 20 seconds, adjustable in 1/10 seconds increments. There are two settings: pressing the button once will dispense for time setting 1, and a quick double-press will dispense for time setting 2. To program the metered water volume exiting the hot water tap, use the detailed instructions below.

1. Scroll to the Password screen and enter the code for Manager menu access
2. Scroll to the screen labeled Hot Water Program Dose and select.
3. Scroll to select the dispensing time for setting 1 and press the button to accept. The same options will now be available for time setting 2. Repeat the process.

SCREEN EXAMPLE:

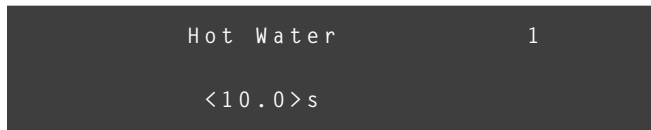

4. Long press and hold the program button to save and exit the menu.

### STEAM BOILER PRESSURE

Steam pressure is displayed on the Home menu. Pressure is displayed in 1/10 bar increments and is adjustable between a range of .08 bars to 1.5 bars of atmospheric pressure. The colon will flash when the steam boiler is heating. To adjust the steam boiler pressure review the details below.

1. Scroll to the Password screen and enter the code for Manger menu access
2. Scroll to the screen:
3. Steam Boiler Pressure
4. Adjust the pressure by turning the button clockwise to raise the pressure in tenth bar increments (0.1-bar), and counter clockwise to lower the pressure.

PROGRAM SCREEN:

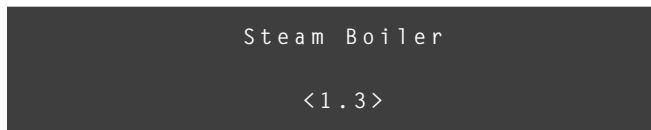

5. Long press and hold the menu button to save and exit the menu.

Adjusting this value can increase the pressure in which the steam exits the steam wand. Adjust accordingly to achieve the "just right" steam pressure along with exceptional technique needed to achieve perfect microfoam.

### RESET COUNTERS: SHOT COUNTERS

Each group is equipped with the ability to record the number of times a shot is dispensed. The value is NOT recorded as a shot if the total Brew time is less than five (5) seconds, thus removing the false reading associated with purging the group before and after a shot is extracted for cleanliness. Viewing the counters showcases usage per programmed position as well as manual shots per group as well as hot water doses and steam activations and can act as a record of how the machine is used. Viewing this count is done in the Home menu with no password needed. The values can be reset any time from the manager menu. An unchangeable permanent value can be viewed in the Advanced Menu under the title Lifetime Count, details on page 35.

1. Scroll to Passwords, enter your password for the Manager menu.
2. Scroll to Reset Counters.
3. Scroll and select YES or NO.

SCREEN EXAMPLE:

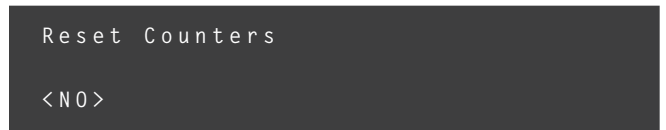

4. Long press and hold the program button to save and exit.

**Scalding hazard! Use the appropriate insulating devices to move the water and steam nozzles.**







### CALIBRATING SHOT WEIGHT OFFSETS

Using volumetrics, Slayer Steam LP uses offsets to account for water absorbed by coffee during extraction.

- It is recommended to use this feature any time you change coffee, grind setting, or dose.

- It is also recommended when dialing in the offset during daily setup or shift change as it is very easy to adjust offsets on the fly by periodically measuring shot output weights with a scale

Using offsets are an effective way to ensure accurate and consistent shots. This feature is accessible through more than one menu for convenience.

1. Follow the Steps under the PREPARE ESPRESSO section on pg. 28 or prepare a shot in Manual Mode with any desired method, using a scale to measure shot weight
2. When the shot is complete, press the Manual Mode Button

**SCREEN EXAMPLE:**

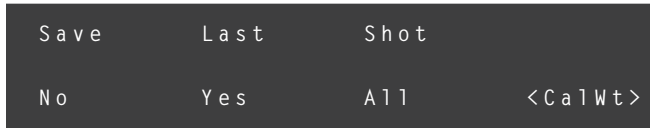

3. Scroll to <CalWt> and press the menu button to enter
4. The screen value default is 30.0g. Scroll to adjust this value to the nearest 0.5 g of the value on the scale for the shot. Press the menu button to accept.

**SCREEN EXAMPLE:**



5. The screen will return to the previous set of options for saving and copying the shot if desired. Or press and hold the menu button to save and exit to the home screen.

### SHOT WEIGHT OFFSET CALIBRATION (ALTERNATE PROCEDURE)

1. Prepare and complete a saved shot (Shot 1 or Shot 2) using a scale to measure total shot weight.
2. From the Home screen, scroll to Enter Password to access the Manager Menu
3. Scroll to "Cal Shot Wt Offset" and press the button to enter
4. Scroll to choose and press to accept both the Group position and Shot number that was just measured.
5. The screen will display the expected weight of the shot.

**SCREEN EXAMPLE:**

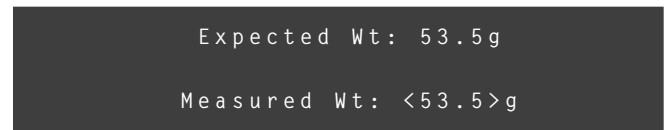

6. Scroll to enter the reading on the scale as the measured weight to the nearest 0.5 gram.
7. Press and hold the menu button to save and exit.



## ADVANCED MENU, PASSWORD PROTECTED OPTION

The second level of navigation is the Advanced Menu, and is a continuation of the Manager Menu higher level access to critical settings and Preventative Maintenance services done by a Slayer certified technician. We have intentionally removed the password for this section for ease of setup but recommend you password protect to remove the potential for unintentional reboots and adjustments without the proper calibration tools or knowledge base. The list below showcases the extended menu with Advanced programming options.

While navigating the Home menu, access the Advanced Menu by scrolling to the "Password" title screen and entering < > leave the value blank if visiting for the first time. To program both the Manager and Advanced Menu password, visit the instructions on page 22.

- Do not interact with the Advanced Menu before reading this manual in its entirety. Then - if unsure - consult your Slayer representative, reseller, or qualified service personnel.

### ADVANCED MENU OPTIONS

1. Service Notification
2. Brew Parameter Adjustments
3. Brew Group Temperature
4. Hot water Tap Program Dose
5. Steam Boiler Pressure
6. Totals Reset
7. Auto-Flushing
8. Calibrate Shot Weight Offsets
9. **Heater Control Element ON/OFF**
10. **Temperature C / F**
11. **Shot Light Brightness**
12. **Lifetime Count**
13. **Set Time/Date**
14. **Times for Power Save to Begin**
15. **Times for Power Save to End**
16. **Service Notification (Reset)**
17. **Passwords (Reset)**
18. **Brew Temp Offset**
19. **Post-Brew Vent**
20. **Auto-Fill Delay**
21. **Flowmeter Calibration**

- The basic Manager Menu only displays the first eight options.

### HEATING ELEMENTS ON/OFF

This menu allows for individual boilers both brew and steam to be turned ON or OFF.

1. Scroll to the Passwords title screen press and type in the password for the Advanced Menu.
2. The option to adjust ALL heating elements ON/ OFF, universally, will be presented.
3. Rotate the menu button to cycle between "On" and "Off".
4. Press and release the menu button to confirm your new setting and proceed to the next step.
5. Repeat steps 4-5 for all remaining settings:
  - Gp1 (heating element for leftmost brew tank)
  - Gp2 (on 2-group, right brew tank; on 3-group, middle brew tank)
  - Gp3 (rightmost brew tank; 3-group only)
  - Stm (steam tank)
6. Long press and hold the button to save and exit

### TEMPERATURE °C / °F (SELECTION)

All temperatures displayed can be shown in either Celsius or Fahrenheit. Once selected this readout will be visible across brew and steam tanks. To adjust the temperature readout in °C or °F follow the details below.

1. Scroll to the Password title screen, select and enter code for the Advanced Menu.
2. Rotate the menu button clockwise until the "Temperature" setting appears.
3. Press and release again to enter the "Temperature" setting. The option to adjust the unit of temperature measurement will be presented.
4. Scroll to cycle between "F" (Fahrenheit) and "C" (Celsius).
5. Press and hold the menu button to save and exit

To adjust the boiler temperatures, see instructions under Using Slayer > Adjust Brew Tank Temperature in the Manager menu on pg. 26.



### SHOT LIGHT BRIGHTNESS

Shot lights are positioned under each group to illuminate the extraction and give better visibility to the quality of the shot being dispensed. The brightness of these LEDs is dimmable from 0 to 100 percent.

1. Scroll to the Passwords title screen in the Home menu, select and enter the correct Password for the Advanced Menu.
2. Scroll to "Shot Lights Adj. Brightness" and press the button to enter
3. Scroll to the desired percentage brightness 0 to 100. Press enter to accept.
4. Long press to save and return to the Home Menu.

### LIFETIME COUNT (SHOT COUNTER)

A non-resettable number displays the total count of shots extracted over the lifetime of the machine, per group head (and not individual button counts). Scrolling through this menu will showcase the full shot counts per group for all programmable volumetrics. A shot is not recorded if the button is turned On and Off within 5 seconds of being activated, excluding the group purge or rinse from the total value. To successfully view your shot counts to date use the details listed below. The hot water tap total count is also visible in this menu.

1. Scroll to the Passwords title screen in the Home menu, select and enter the correct PW for the Advanced Menu.
2. Turn the menu button clockwise to Lifetime Count enter the menu by depressing the button.
3. Scroll through the menu to read the number of shots extracted on each group.

SCREEN EXAMPLE:

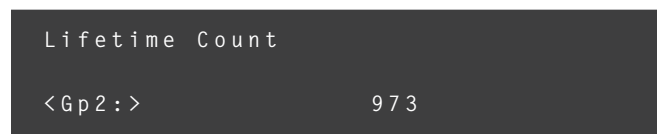

4. Scroll to see the number of times the Hot Water Tap button has been engaged

SCREEN EXAMPLE:

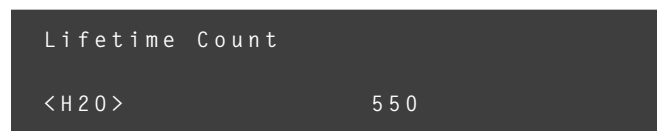

5. Long press (5 sec.) and hold to exit the Home Menu, short press (2 sec.) to continue working in the Advanced menu program platform.

### SET TIME/DATE

Setting time and date is critical in order to utilize Power Save mode and to enact your countdown to service clock. Use the following steps to set Time and Date.

1. Scroll to Passwords, enter your password for the Advanced Menu
2. Rotate the jog wheel clockwise until the "Set Time/ Day" setting appears.
3. Press and release the jog wheel to enter the "Set Time/ Day" setting. The option to adjust the clock type will be presented.
4. Rotate the jog wheel to cycle between "12H" (12-hour clock) and "24H" (24-hour clock).
5. Press and release the jog wheel to confirm your new setting and proceed to the next step. The option to adjust the hour will be presented.
6. Rotate the jog wheel to adjust the hour.
7. Press and release the jog wheel to confirm your new setting and proceed to the next step.
8. Repeat steps 6-7 for all remaining settings:
  - Min (minute)
  - Day
9. Long press and hold the program button save and exit the menu

- Time/Day must be programmed before you can move onto setting up
- Power Save options.

### TIMES FOR POWER SAVE TO BEGIN/ END

- **REMINDER:** Time and date must be set in advance to proceed with the setup of Powersave mode. Power-save settings can be set to all days or individual daily schedules if hours of operation change from weekday to weekend schedules. When power-save is "OFF", all systems are normal.
- When power-save is "ON", the machine is in sleep mode.

When the machine is in power save mode the resting values are as follows:

- Steam pressure is reduced to 0.3 bars
- Brew temperatures are reduced to 100.0° F (37.7 C)

All systems begin heating for normal operation thirty (30) minutes before power- save is scheduled "OFF".



### Set: Power Save Begin

1. From the Home menu, scroll to Passwords and enter the Advanced menu password.
2. Rotate the menu button clockwise until the "Times For Power Save To Begin" title screen appears, press to enter.
3. Set the time.

#### SCREEN EXAMPLE:

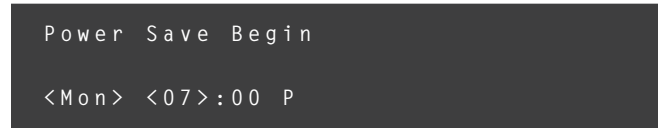

(Example times displayed, set accordingly)

4. Choose to Copy ALL days <YES> or <NO> and set individual times for power save to begin if closing times vary day to day.

- **PROTIP:** For ease of programming, choose Program ALL days the same, then individually adjust Saturday and Sunday start and end times as needed.

### Set: Power Save End

1. From the Home Menu, scroll to Passwords and enter the Advanced menu password
2. Rotate the menu button clockwise to "Times For Power Save to End" title screen appears, press to enter
3. Set the time.

#### SCREEN EXAMPLE:

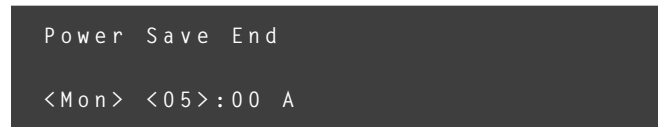

4. Choose to "Copy ALL days" <YES> or <NO> and set individual times for power save to end if cafe hour start times vary.

## RESET SERVICE NOTIFICATIONS

Preventative Maintenance is ongoing and key to optimum performance of your espresso machine. Daily, weekly, quarterly and ANNUAL maintenance should be done ahead of issues to prevent costly breakdowns and extensive repairs. The Slayer Steam LP alerts you via a countdown clock of when your next suggested Preventative Maintenance repair should be done. Based on volume you can schedule your countdown clock to start at 12, 6 or 3 months depending on your volume. After 30 days the countdown drops by one month. If the counter goes lower than 1 month it will now read in negatives, a warning that service is in past the recommended scheduled. To reset the countdown toward your next

service notification after a Preventative Maintenance service has been performed on your machine use the following steps.

1. Scroll to the Password screen in the Home menu, select and enter the code for the Advanced menu.
2. Scroll to Service Notification and select.
3. Scroll to select <No> or <Yes>.
4. If <Yes> is selected, a prompt will ask you to choose the interval to begin the countdown.
5. Select your interval, press to save.
6. Press and long hold to save and exit.

### Disable Service Notifications

1. Scroll to the Password Screen in the Home menu, select by depressing the Menu button and enter the code for the Advanced menu.
2. Scroll to Service Notification, depress the menu button to select.
3. Scroll to Select <Yes>.
4. Select the option <OFF>.
5. Press and hold (2 seconds) to save and exit back to the Advanced menu or long hold (5 seconds) to exit to the Home Menu.

## MASTER PASSWORD RESET

Please see the section on Enabling and resting Passwords on pg 22.



## BREW TEMP OFFSET (PROGRAMMING)

- **IMPORTANT:** To configure the offsets, you must have a scace device or
- defer to a certified Slayer technician. This can NOT be performed with
- hand held temperature probes.

Brew temperature calibration settings are used to ensure accurate heating by compensating for physical variations between temperature probes.

Use the offsets to adjust displayed brew temperature, when different from actual. Brew temperature offsets are adjustable in tenth-degree (0.1-degree) F or C increments.

### Brew temp offset

When adjusting a brew temp offset you will need a scace device or the professional services provided by a Slayer technician.

1. Press and hold the jog wheel above the left group head for five seconds to activate the Advanced Menu options.
2. Rotate the jog wheel clockwise until the “Brew Temp Offset” setting appears.
3. Press and release the jog wheel to enter the “Brew Temp Offset” setting. The option to adjust the offset for the leftmost group head (Gp1) will be presented.
4. Rotate the jog wheel to adjust the brew temperature offset for the leftmost group head in tenth-degree (0.1-degree) Fahrenheit increments: clockwise rotations increase the offset value; counter-clockwise rotations decrease the offset value.

- If the displayed brew temperature is lower than the actual brew
- temperature, increase the offset value. If the displayed brew
- temperature is higher than the actual brew temperature, decrease
- the offset value.

5. Press and release the jog wheel to confirm your new setting and proceed to the next step.
6. Repeat steps 4-5 for all remaining settings:
  - Gp2 (on 2-group, right brew tank; on 3-group, middle brew tank)
  - Gp3 (rightmost brew tank; 3-group only)
7. Press and release the jog wheel to confirm your new setting and return to the menu for additional adjustments OR move the brew actuator Left to Right to save and exit the Advanced Menu.

## POST BREW VENT

The Post Brew vent feature is included to help quickly depressurize the group back to low pressure when the extraction enters the post-brew phase. It is recommended to keep Post-Brew vent on, but can be disabled through the following steps

1. Scroll to the Passwords title screen in the Home menu, select, and enter the correct Password for the Advanced menu
2. Scroll to Post Brew Vent and press the button to enter the menu
3. Scroll to <Off> to turn off the vent functino or <On> to keep the feature enabled
4. Press and hold to save and exit the menu

## AUTO FILL DELAY

To prevent pressure loss during espresso brewing and in order to prioritize consistent brew parameters the machine firmware has the ability to prevent boiler autofill while extracting espresso on any group head. The stock setting for Auto Fill Delay is <DISABLED>.

1. From the Home Menu, scroll to Passwords and enter the Advanced Menu password.
2. Scroll to Auto-Fill Delay
3. Choose < ENABLE >
4. Press and long hold the menu button to confirm your new setting and exit to the Home menu.

- **NOTE:** this feature is not recommended for cafes making 500-
- 1000+ drinks per day.



## FLOW METER CALIBRATION

The flow meter calibration is designed to ensure that volumetrics set points are consistent group to group. A modification to this parameter applies an offset to the entire group, not just a particular shot. Use this method if both shots on a group are not accurate. See the section on Calibrate Shot Weight Offsets on pg 32 for shot to shot adjustments on a particular group. While factory set manufacturer tolerances are minimal between flow meters, Slayer has applied the following calibration exercise to sync up subtle performance differences, to ensure consistent performance group to group.

1. The first objective is to reset the flow meter offset to 0 g. To do this, scroll to the Advanced or Manager menu prompt and enter the password if required. Scroll to Cal Shot Wt Offset and press the button to select.
2. Scroll through the values until the maximum value for Measured Wt is reached. (When <0.0>g is reached, click in the opposite direction for the maximum offset). Press the menu button to select and save.
3. Copy this offset to all groups when prompted.
4. Remove dispersion screw and shower screen from the groups. See Fig. 1 on pg. 41.
5. Using the Brew Parameters menu, program a desired shot weight (ex: Pre: 0s | Brew 50.0g | Post 0g) to position 1. Copy to All groups.
6. Using a scale to measure shot weight, dispense and record the weights of several shots of water and take a reasonable average of the results. **Subtract this number from the expected shot weight displayed on the screen and multiply by (4) four. This is the offset value.**
7. Press the menu button and enter the password, if enabled, to access the Advanced Menu.
8. Scroll to Flow Meter Calib. and press enter to select.
9. If the Expected Shot Weight is greater than the Measured AverageWeight of the test, scroll to enter the offset value in pulses as a negative number.

### SCREEN EXAMPLE:

```
Flowmeter Calib.  
Gp1: <-10> puls
```

If the Expected Shot Weight is less than the Measured Average Weight of the test, scroll to enter the offset value in pulses as a positive number.

Ex:

Average of Shots = 47.5 g;

Expected Shot Wt as shown on the display = 50.0 g

Difference = 2.5 g x 4 = 10

AND

Measured Wt < Expected Shot Wt, so enter -10 offset value

10. Press and hold the button to return to the home menu.
11. Verify that the new calibration is accurate: by running the programmed shot again and comparing it to the actual weight.
12. Repeat steps 6 through 11 for the additional groups.

Now that flow meters have been calibrated group to group, individual shots can be further fine-tuned using the Calibrate Shot Weight Offset option. See pg. 32.



# Cleaning & Preventative Maintenance

Keeping your machine clean and properly maintained is essential to ensuring espresso quality and equipment longevity. Espresso machines require both daily cleaning and ongoing periodic maintenance. The frequency with which these tasks should be completed will depend on the location and use of your espresso machine. The following instructions assume heavy use in a commercial setting. Inquire with our spare parts department to order preventative maintenance (PM) kits for use every 12-18 months.

Visit [slayerespresso.com/support](http://slayerespresso.com/support), and explore our knowledge base for details on preventative maintenance.

## CONTENTS

Clean the Machine Exterior	39
Clean the Steam Wands	39
General Group Head Care	39
Backflush the Group Heads	40
Fast Clean	42



## CLEAN THE MACHINE EXTERIOR

Use a soft, clean towel to wipe the surfaces of the machine. Do not use abrasive cleaners. Small amounts of window cleaner may be used on glass and metal components.

## CLEAN THE STEAM WANDS

Immediately after steaming milk, clean the exterior of the steam wand by wiping it thoroughly with a damp towel, then clear the interior by briefly moving the steam actuator up to the “purge” position.

If clogging occurs, soak the steam wand in hot water for several minutes, then purge while submerged. For tough clogs, use toothpick to unplug the holes in the tip and use an approved espresso machine steam wand cleaning solution.

## GENERAL GROUP HEAD CARE

Regular cleaning and backflushing optimizes machine performance and espresso flavor by preventing the buildup of coffee oils. Complete the following steps for each grouphead as part of every backflush cycle or as needed, at least once daily.

### REQUIRED TOOLS

- Cleaning brush
- Flat-head screwdriver

### RECOMMENDED SUPPLIES

- Soft, clean towel

### PROCEDURE

1. Remove portafilter from group head, then use a cleaning brush to scrub the portafilter gasket, loosening oil and coffee grounds.
2. Use a flat-head screwdriver to remove the dispersion screw and shower screen, then rinse with clean water.
  - Ensure that the dispersion screw holes remain clear of coffee grounds, as they may otherwise damage internal parts of the group head.
3. Use a damp towel to wipe oil and grounds from the face and sides of the dispersion block, as well as the portafilter body.
4. Return the clean dispersion screw and shower screen to the group head.
  - Failure to reinstall the dispersion screw and shower screen before next use may cause the group head to clog. Do not attempt to brew espresso or backflush the group head before the dispersion screw and shower screen have been correctly installed.
5. Rinse the portafilter with hot water, then insert the portafilter basket and lock it in the group head.





## BACKFLUSH THE GROUP HEADS

Through the Barista Dashboard, Slayer Steam automates backflush cycles for each group head. Backflush with an approved espresso machine cleaning powder at least once daily. Complete the “Fast Clean” procedure as needed.

To maximize efficiency and lengthen the life of wearable parts, keep on hand two (2) complete sets of shower screens, dispersion screws, portafilter baskets, and portafilter springs. Alternate between sets for each full backflush cycle.

### INCLUDED PARTS

- Blind portafilter insert
- Replacement portafilter

### REQUIRED TOOLS

- Cleaning brush
- Flat-head screwdriver

### RECOMMENDED PARTS & SUPPLIES

- Replacement shower screens, one (1) per group head
- Replacement dispersion screws, one (1) per group head
- Replacement portafilter baskets, one (1) per group head
- Replacement portafilter springs, one (1) per group head
- Approved espresso machine cleaning powder
- 1 liter (or larger) heat-tolerant container
- Soft, clean towel

### PROCEDURE

1. Complete “General Group Cleaning” steps 1-3 on page 42. Set aside shower screens and dispersion screws.
2. Prepare a solution of hot water and approved espresso machine cleaning powder in a 1 liter (or larger) heat-tolerant container.

3. Remove portafilter baskets and portafilter springs from all portafilter bodies.
4. Add all shower screens, dispersion screws, portafilter baskets, portafilter springs, and portafilter bodies to prepared solution. Soak for a minimum of 20 minutes, then rinse thoroughly with clean water. Meanwhile, complete remaining steps.
  - Do not submerge portafilter handles in solution
  - or fading will occur.
5. Use a flat-head screwdriver to install a second set of shower screens and dispersion screws, then complete the following steps for each group head.
6. Install a blind insert in a replacement portafilter, add cleaning powder, and lock it in the group head.
7. Press and release the jog wheel on the Barista Dashboard™ to activate the menu.
8. Rotate the jog wheel clockwise until the “Group Cleaning” setting appears.
9. Press and release the jog wheel to enter the “Group Cleaning” setting. The option to select a cleaning program will be presented.
10. Rotate the jog wheel to cycle between cleaning programs:
  - All (all group heads)
  - Gp1 (leftmost group head)
  - Gp2 (on 2-group, right group head; on 3-group, middle group head)
  - Gp3 (rightmost group head; 3-group only)
11. Press and release the jog wheel to select and initiate a cleaning program. A countdown will begin at the group head(s) running the cleaning program. The cleaning program is complete when a buzz sounds and the shot light pulses.
12. Follow the prompt on the screen to remove the portafilter(s) from the group head(s), then press and release the jog wheel to continue a purging cycle. The purging cycle is complete when the shot light pulses, after approximately thirty (30) seconds.
13. Reassemble the portafilter, inserting the portafilter spring and portafilter basket, then lock it in the group head.
14. Repeat steps 6-13 for each group head, as needed.



## Basic Backflushing Steps

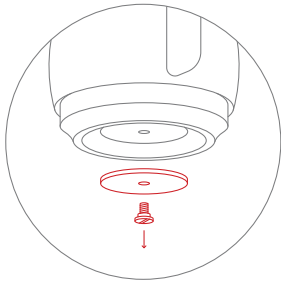

1

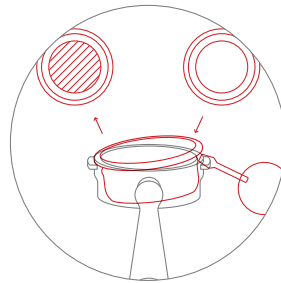

2

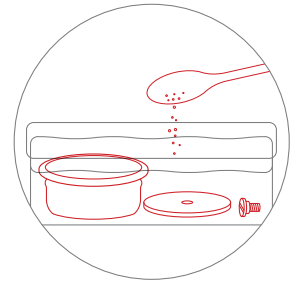

3

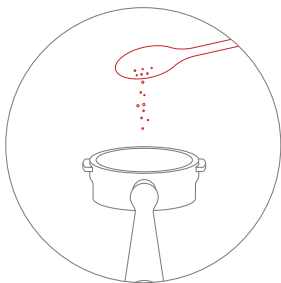

4

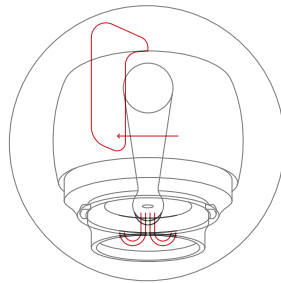

5

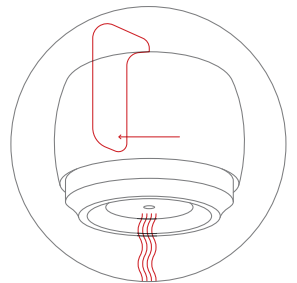

6



7

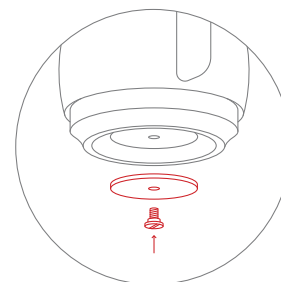

8

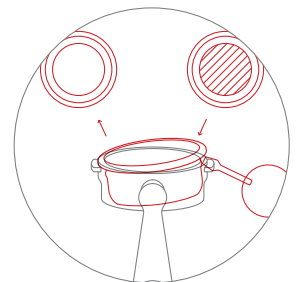

9



## FAST CLEAN

Designed to be done without the use of detergent after the busy portion of the day, at the shift change or when changing out the coffees in the hopper. Leave the screen, screw in place. Complete the following steps for each group head whenever your machine requires minor cleaning.

### INCLUDED PARTS

- Blind portafilter insert

### REQUIRED TOOLS

- Group brush or non-fiber towel

### RECOMMENDED SUPPLIES

- Soft, clean towel

### PROCEDURE

1. Remove portafilter from group head, then use a cleaning brush to scrub the portafilter gasket, loosening oil and coffee grounds.
2. Replace portafilter basket with a blind insert and lock it in the group head.
3. Press and release the menu button above the group head to activate the menu.
4. Rotate the menu button counterclockwise to the "Fast Clean" setting.
5. Press and release the menu button to enter the "Fast Clean" setting. The option to select a cleaning program will be presented.
6. Press and release the menu button to select and initiate Fast Clean.
7. Follow the prompt on the screen to remove the portafilter from the group head, then press and release the menu button to continue.
8. Remove the blind insert from the portafilter and use a damp towel to wipe oil and grounds from portafilter body.
9. Rinse the portafilter with hot water, then insert the portafilter basket and lock it in the group head.
10. Repeat all steps for each group head, as needed. This feature is available per group and intuitively placed last on the menu for counter clockwise turn to, quick activation.



Make  
Coffee  
Better