

99-00 Civic EK

K-Series Swap Conversion Wiring Harness V 4.0 Installation Manual

Below you will find tips on how to install your new Hybrid Racing K-Series Conversion wiring harness.

*This harness may not be legal for highway use. Hybrid Racing is not responsible for any direct or indirect, actual or incidental expense attributed to the use of any performance parts sold by Hybrid Racing LLC. Purchasers agree to all of the terms of this agreement upon the purchase of parts. More information can be found at www.hybrid-racing.com.

Harness Features:

- 100% brand new connectors and pins.
- Integrates your K-series engine harness into your chassis harness and ECU.
- Nylon braided sleeving for safety and cleanliness.
- Oxygen sensor relay
- Lifetime Hybrid Racing tech support at support.hybrid-racing.com

Package Contents:

- Conversion wiring harness.
- Connectors.
- Zip Ties.
- Flyer with link to install guide.
- HR fresh Louisiana air.

Recommend Tools:

- Wire Strippers
- Wire Snips
- Extra Zip Ties
- Solder & Soldering Iron
- Heat shrinkable tubing
- Electrical tape (This is **NOT** an acceptable material to cover exposed wire core)
- Complete socket set & ratchet
- Razor blade, knife or scissors.
- Applicable chassis wiring manual (for trouble shooting)
- Voltmeter (for trouble shooting)

Important!! Please read the entire install guide twice before starting your installation. No, really it's a good idea to read it twice before you begin so everything goes smooth ;)



Introduction & Installation Notes

A little bit of K-series information to make sure you have the right parts before you get started!

While the Hybrid Racing Conversion Wiring Harness is 99% plug-n-play, there are a few wires that need to be connected after the harness has been installed into the car. Because it involves electricity, there is always the risk of damaging electronic devices, such as fuse boxes, ECU's and sensors among other things. Hybrid Racing strongly urges the installer of this product to become familiar with wiring and common wiring procedures before attempting to install this product.

If you are unsure of something, or have any questions regarding this product or its installation please feel free to create a support ticket at support.hybrid-racing.com or email us at support@hybrid-racing.com. Remember its easier and cheaper to email us than it is to damage something and have to replace it.

This wiring harness is designed to integrate a K-series engine into the chassis specified on the first page of the install guide, it serves no other function. It allows the engine, ECU and the chassis to communicate together. Without it, the car will not function.

Each engine wiring harness requires the use of a charging harness. You must have a charge harness installed or your car will not crank and run properly. This charge harness connects the alternator and starter directly to the battery and fuse box. ****All charging harnesses are NOT the same****. To avoid using the wrong charge harness use the charge harness from the same chassis that your motor and engine harness came from.

I. Engine Harness Selection

Below is a list of engine harnesses that are **COMPATIBLE** with the HR conversion harness:

- **K20A (JDM 01-05 DC5 Type R)**
This engine wiring harness is made for RHD cars and is shorter than the LHD versions. Depending on how it is routed, it may be necessary to extend the end of the harness so that it reaches into the cabin. It also does NOT have an oil pressure switch connector.
- **K20A2 (USDM 02-04 DC5 Type S)**
This is the most commonly used engine wiring harness. It is the best length and works with both a 5spd and 6spd transmissions.
- **K20A3 (USDM 02-05 EP3 & 02-04 DC5 Base *5spd only)**
This engine wiring harnesses is for 5spd transmissions and will NOT have the connector for the reverse lock out solenoid on the transmission. This is not necessary but if you want to have this function you will need a 6speed engine harness and ECU.

These engine harnesses **ARE NOT** compatible with this conversion harness:

- **K20Z1 (USDM 05-06 DC5 Type S)**
This harness does NOT support the 05-06 RSX KPRO.
- **K20Z3 (USDM 06+ FG Civic Si)**
Has Drive-By-Wire and different ECU connectors.
- **Any K24 harness**
(any year, 5spd or auto)

If you have a harnesses that is not compatible, please obtain one of the compatible engine harnesses before continuing with the installation. If you connect this conversion harness to the wrong engine harness, you can damage the ECU, engine sensors and any wiring ***This is VERY important* if you are unsure email us at support@hybrid-racing.com with a picture of your parts and we will help you figure it out.**

II. K-series ECU Options

Ranked in order of Hybrid Racings preference. For questions on all of the options you can create a support ticket at [support.hybrid-racing.com](mailto:support@hybrid-racing.com) or email us at support@hybrid-racing.com

1. Hondata Kpro

If you are utilizing a Kpro you will need to follow the steps outlined in this install guide to set everything up properly.

ECUs that can be Kpro'd and used with the hybrid racing harness.

PRB with code number A01-A12 and 305 02-04 RSX manual
PND 02-04 Base RSX manual
PNF 02-04 Civic Si manual
PRC 02-04 JDM Integra Type R manual
PPA 02-04 CRV manual
PRD 02-04 CTR manual

ECUs that will not work with the hybrid racing harness

PRA 02-04 Civic Type R (technically possible to have Kpro'd but will not have a wide-band)
PRB A13-A16 05-06 RSX

2. US SPEC Stock ECU's with an HR immobilizer removal unit. You can see this unit on the Hybrid Racing website.

All US spec K-series ECU have a built in immobilizer system. If you want to use a stock ECU you will need to purchase the HR immobilizer removal box. If you have a stock ECU and no HR immobilizer removal box your ECU will not turn on the fuel pump and it will not send a signal to your coil packs. You can use the HR immobilizer box with the following ECU's

PRB with code number A01-A12 and 305 02-04 RSX manual
PND 02-04 Base RSX manual
PNF 02-04 Civic Si manual
PPA 02-04 CRV manual

Please use the ECU that is most suitable for your engine. For example, if you have a K20A2 from an 02-04 RSX it is best if you use a K20A2 PRB ECU!

No other ECU's will work with the immobilizer box and the Hybrid Racing harness.

3. JDM TYPE R PRC ECU.

If you have access to a JDM Type R ecu with the code PRC you do not need to utilize the HR immobilizer removal box. This ECU does not have the same type of immobilizer. You will still need to ground one wire to kick your fuel pump on as outlined later in the install guide.

4. AEM EMS

If you are utilizing an AEM EMS you will need to defer to there installation manual.

5. Other

There very well may be more options if you have questions you can create a support ticket at [support.hybrid-racing.com](mailto:support@hybrid-racing.com) or email us at support@hybrid-racing.com

Getting to know your conversion harness.

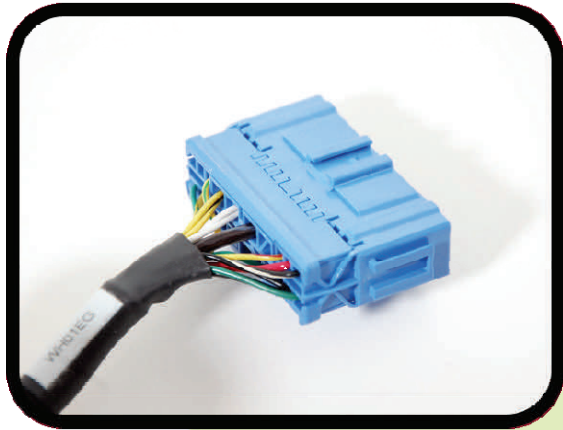

1. This is your C302 connector plug and it connects to your K-series engine harness.

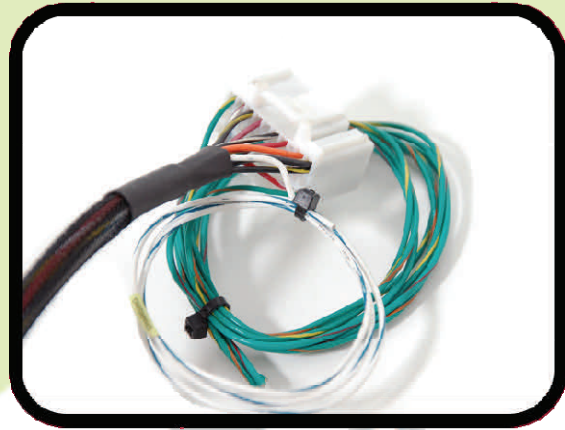

2. This is your E plug connector and it plugs directly into your K-series ECU.



3. This is the C131 connector and it connects under your dash on the passenger side.



4. This is your C101.1 connector and connects under your driver side dash.

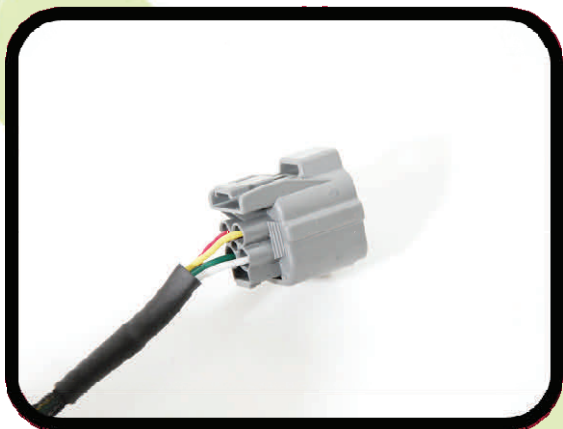

5. This is the primary connector plugs into the k-series wideband oxygen sensor

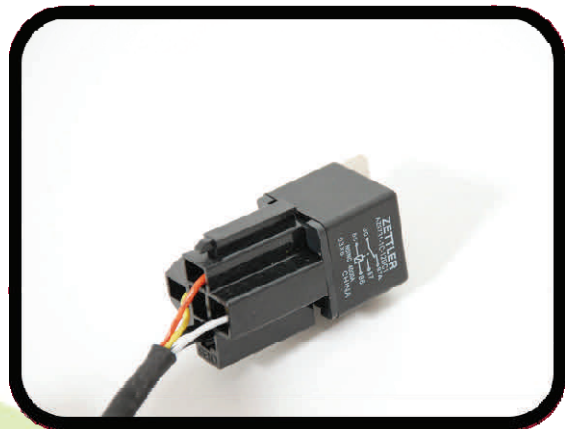

6. This is the oxygen sensor relay. Now that you are familiar with the connectors head to the next page.

Quick Overview

- 1. Run stock K-series engine harness through fire wall.**
- 2. Install conversion harness and ECU under dash.**
- 3. Connect 6 wires from conversion harness.**
- 4. Plug in all connectors and secure everything on passenger side.**
- 5. Run conversion harness to driver side.**
- 6. Route/Connect 3 wires into engine bay on driver side.**
- 7. Route Oxygen sensors.**
- 8. Setup Kpro.**
- 9. Connect battery and confirm charge harness is in place.**
- 10. Finished.**

Install Guide



STEP 1: Remove the battery, and battery tray. Once all of these things are out of the way you should be staring at a Grommet on your firewall held in with 2 10mm bolts. This is where your OEM engine harness entered the cabin.



STEP 2: Remove the OEM grommet from your K-series engine harness as well as from your stock D/B series engine harness. You are going to use the one from your old engine on the new K-series harness.



STEP 3: Using the stock grommet from your OEM D/B series engine harness run your engine harness connectors through the firewall. Secure the grommet back into the firewall and use a little electrical tape to wrap the grommet to the K-series engine harness. Once this is done you can reinstall your fuse box and battery tray. We recommend you leave the battery disconnected until everything else is complete.



Install Guide



STEP 4: Grab your ECU and HR conversion harness and move inside the car. Pull back the carpet, kick panel and remove the stock ECU. You should now have your K-series engine harness, the STOCK K-series ECU, STOCK OEM ECU connectors and the HR conversion harness ready to go.

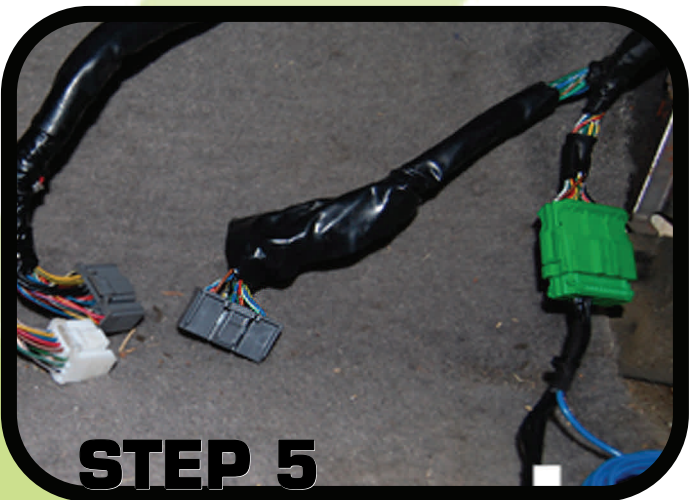

STEP 5: Locate the factory A plug that remains in the car under the dash on the passenger side. This should be a grey connector with 32 pins and is located next to a GREEN CONNECTOR.

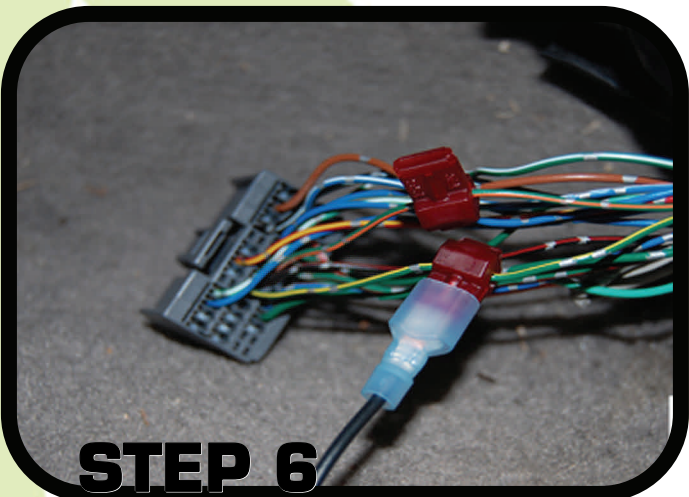

STEP 6: Locate the six wires that run out of the white E plug connector. Go ahead and cut the zip ties holding them together and prepare to connect them to the A plug following the guide in the next step.

STEP 7: 6 Wires from HR Harness

Find and locate the six wires that come off of the Hybrid Racing conversion harness at the ECU E PLUG and connect them using the following GUIDE.

CONNECT THE SIX WIRES AS OUTLINED BELOW:

- ⇒ Connect **E1** a GRN/YEL wire on the HR conversion harness to **A16** a GRN/YEL wire on the STOCK CIVIC ECU CONNECTOR A. This wire controls the FUEL PUMP. *FOR Type R ECU disregard E1 a GRN/YEL wire on the HR conversion harness and GROUND A16 a GRN/YEL wire on the STOCK CIVIC ECU CONNECTOR A.
- ⇒ Connect **E15** a GRN/RED wire on the HR conversion harness to **A30** a GRN/RED wire on the STOCK CIVIC ECU CONNECTOR A. This wire controls the ELD.
- ⇒ Connect **E23** a BLU/YEL wire on the HR conversion harness to **A21** a LTBLU or BLU/YEL wire on the STOCK CIVIC CONNECTOR A. This wire controls the DATA LINK CONNECTOR.
- ⇒ Connect **E26** a BLU wire on the HR conversion harness to **A19** a BLU wire on the STOCK CIVIC CONNECTOR A. This wire controls the TACHOMETER.
- ⇒ Connect **E29** a BRN wire on the HR conversion harness to **A10** a BRN wire on the STOCK CIVIC CONNECTOR A. This wire controls the SCS DATA LINK CONNECTOR
- ⇒ Connect **E31** a GRN/ORN wire on the HR conversion harness to **A18** a GRN/ORN wire on the STOCK CIVIC CONNECTOR A. This wire controls the CHECK ENGINE LIGHT.

HR Harness Connector E

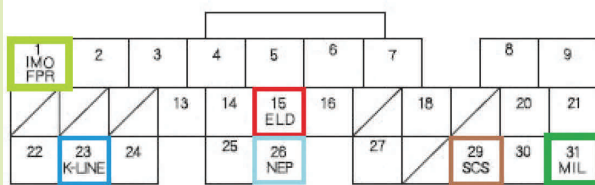

STOCK CIVIC Connector A

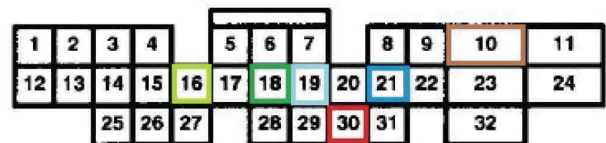

This is an example of how to connect the wires. However soldering is highly recommended as it creates a better connection.

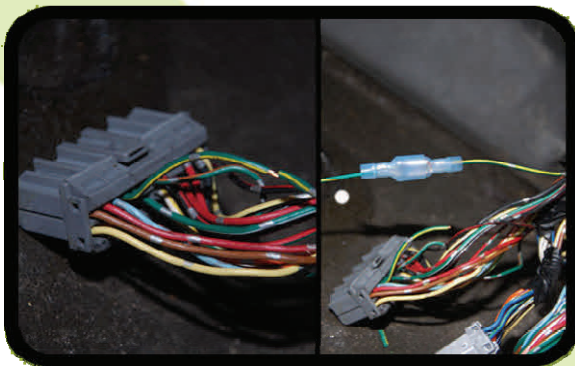

Step 8: Connecting Wire Labeled Charging Light

K-SERIES ECU CONNECTOR B

1	2	3	4	5		6	7	
8	9	10	11	12	13	14	15	16
17	18	19		20	21	22	23	24

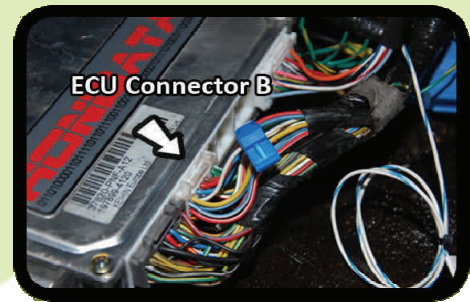

- Connect the wire labeled charging light to B10 a WHT/BLU wire located on K-series ECU CONNECTOR B using the supplied "T" taps DO NOT CUT. This wire controls the battery light on the gauge cluster.

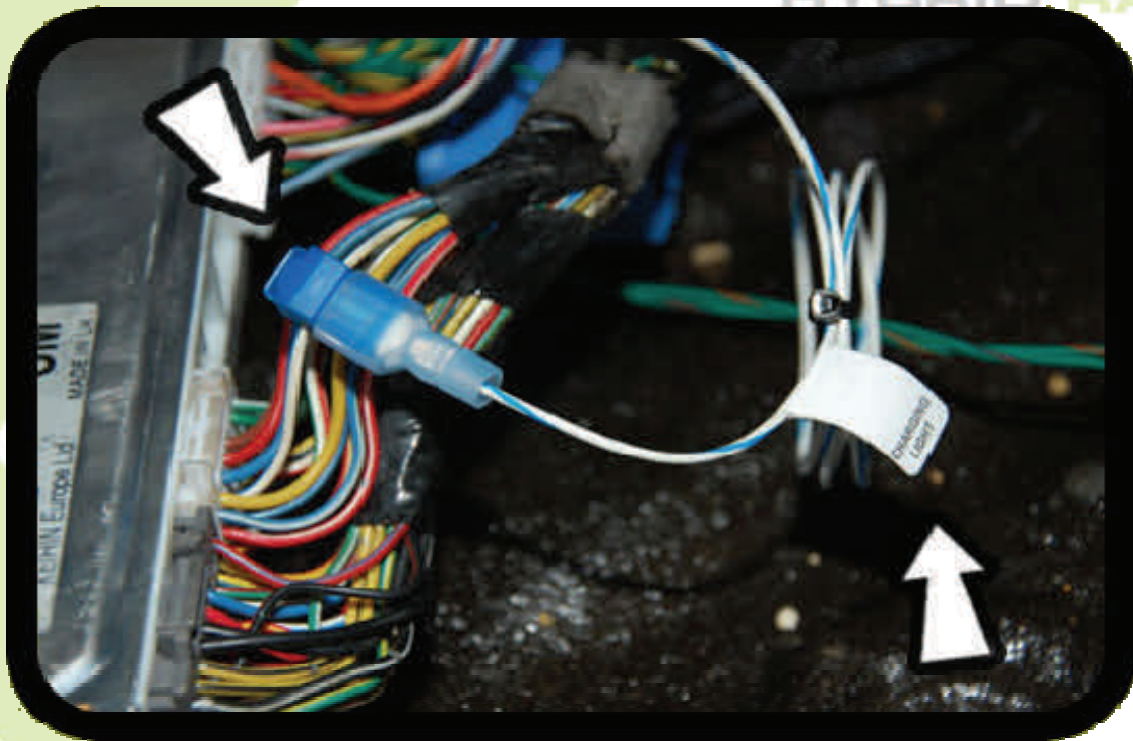

HYBRID RACING

Install Guide

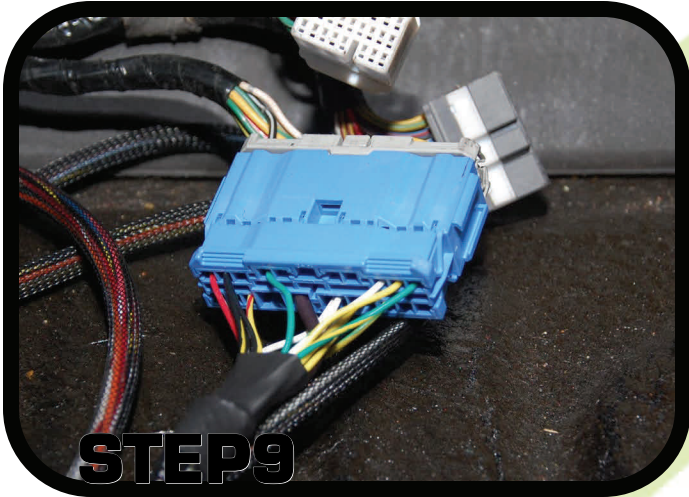

STEP 9: Plug the blue C302 connector from the HR harness into the grey C101 connector from the K-series engine harness AND connect the GREEN C131 Connector on the HR Harness to the GREEN C131 connector on the chassis harness.



STEP 10: Plug the K-series engine harness into the K-series ECU. Plug the white E plug connector from the Hybrid Racing harness into the ECU.



STEP 11: Go ahead and secure the DLC, Oxygen Sensor Relay and mount the ECU. You are now done on the passenger side.

HYBRID RACING

Install Guide

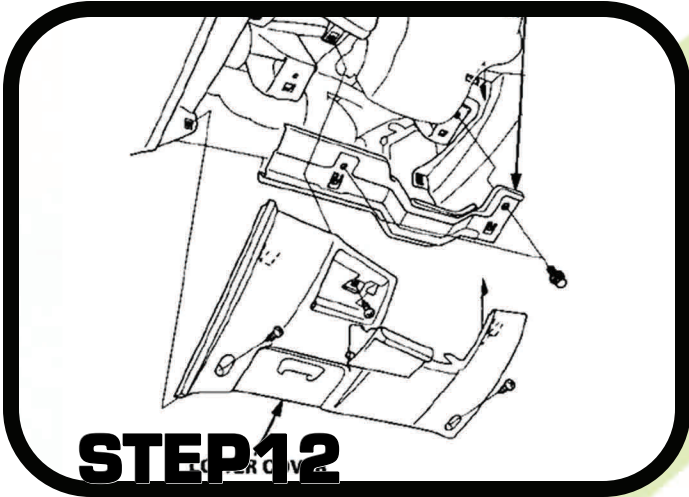

STEP 12: Now that everything on the passenger side is complete go ahead and move to the driver side and remove the lower dash panels so you can gain access to where C101 on the Hybrid Racing harness plugs in.



STEP 13: Route the C101.1 Grey connector on the Hybrid Racing harness to the driver side of your chassis. You can use the supplied zip ties to secure it nicely under the dash.

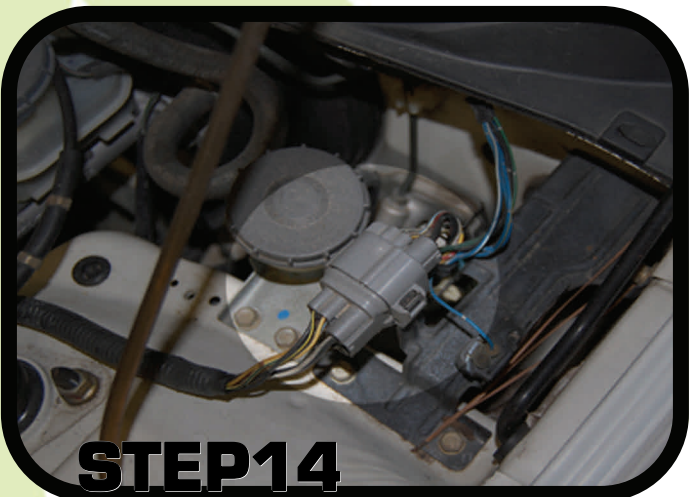

STEP 14: Locate the Grey 10 pin connector in your engine bay. Go ahead and push this connector inside your firewall and connect it to the HR conversion harness.



Install Guide



STEP 15: Connect the C101 connector to the HR harness and cut the zip tie on the bundle of wires. Go ahead and secure the connectors with zip ties and move to the next step.



STEP 16: Route the three loose wires through the grommet located on the driver side firewall. Once the wires are in the engine bay follow the instructions on the remaining pages to connect them. (NOTE: You can also pull the large engine harness connector inside the cabin to clean things up.)



STEP 17: Locate the GRN/WHT wire labeled **FAN SWITCH**. If you are using a Hondata KPRO, the connection of the fan switch is NOT necessary. It is only necessary if you want to have the OEM sensor switch turn the fans on and off. If you would like to have KPRO turn the fan on and off based off a temperature you can skip the fan switch install steps.



Install Guide

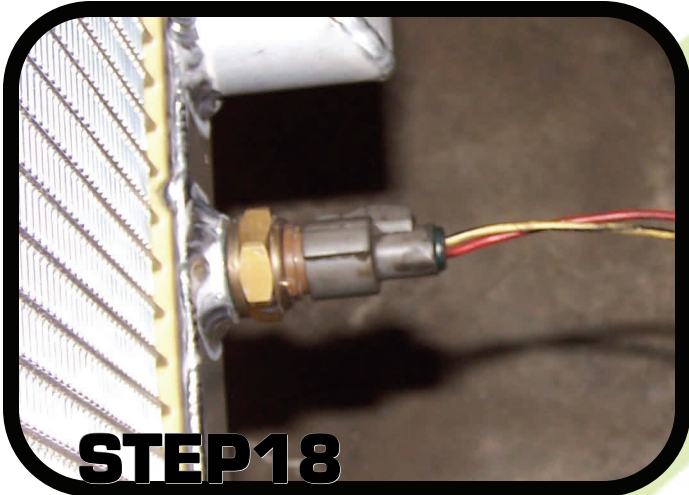

STEP 18: Connect the GRN/WHT wire on the HR conversion harness to ONE wire on the fan switch sensor connector. The other wire on the fan switch sensor connector gets grounded to the chassis. You can locate this connector on your OEM STOCK engine harness, you will need to cut and remove it. Make sure to leave at least 1in of wire to make your connections.



STEP 18: Locate the YEL/GRN wire labeled **COOLANT TEMP** on the HR conversion harness and connect it to the coolant temp sensor connector. You can locate this connector on your OEM STOCK engine harness, you will need to cut and remove it. Make sure to leave at least 1in of wire to make your connec-

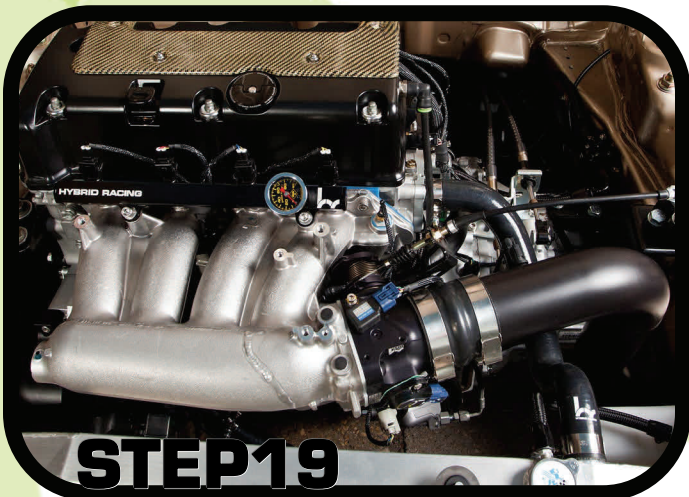

STEP 19: If you have not already done so go ahead and install your charge harness and reconnect your battery.

If you are running a Kpro move to step 20 if not congrats you are done. We have included an FAQ if you run into problems. If you find that you still need help please email us at support@hybrid-racing.com or go to support.hybrid-racing.com and create a support ticket.

Thanks for choosing HR!

STEP 20: Primary A/F Ratio Sensor

Run the connector under the car. You can use one of the small holes already located in your chassis or if you can not find one you can drill a small hole on the top of the tunnel under the radio location. Drop the connector through the floor and plug it into your Oxygen sensor. The below information is useful information for making sure you have the correct sensor.

One of, if not the most important sensors on the K series motor is the A/F ratio sensor. This sensor is located in the factory exhaust down pipe, closest to the motor. This is often called the “primary o2 sensor” or “wideband o2 sensor.”

You **MUST** have this sensor connected properly for the engine to run correctly. Without it, you will have a CEL and will suffer from sluggish performance and terrible fuel economy. There are exceptions to this, like having the car tuned in open loop or running an aftermarket WB (innovative, AEM ect) sensor installed into the harness.

*Note: Some chassis may have a hole in the floor pan of the car that the AFR sensor connector can go through. If your chassis does not have this, you can drill a hole in the floor to run the harness to the sensor in the exhaust.

The **ONLY** OEM style AFR sensors that are applicable are:

- 2002-2004 RSX Type R: OEM Part Number 36531-PRB-A01- Replacement Denso Part Number 13680
- 2001-2006 Integra Type R (JDM)

Sensors that **ARE NOT** compatible for Primary application are:

- 2005-2006 RSX Type S
- 2002-2006 RSX BASE
- 2003-2005 Civic Si (EP3, & UK CTR)
- 2006+ Civic Si
- Any K24 sensor
- Secondary Sensors

International user notes:

The European Civic Type R K20A engines use a narrowband o2 sensor and is NOT compatible with this conversion harness. We accept no responsibility for users that wish to rewire the harness to work with a narrowband ECU, engine wiring harness and sensor. If you would like to change the UK engine harness to work with the US/JDM spec wideband AFR sensor & ECU, please refer to the trouble shooting section at the beginning of this guide.



STEP 21: Secondary Oxygen Sensor

If you are running a KPRO ECU you can SKIP THIS STEP.

You will need to source this connector from your OEM engine harness make sure to leave 2-3in of wire for you to make all of your connections.

Unlike the primary AFR sensor, the secondary o2 sensor is not necessary in most cases. If you are using the Hondata KPRO you can disable this sensor and you do not need to connect it. If you are using a "SWAPECU-K," this may not be necessary to connect either. Check to make sure the sensor has been disabled before continuing.

Secondary o2 sensor compatibility:

- 2002-2004 RSX Type S (& Base 5spd)
- 2001-2006 Integra Type R & Type S
- 2002-2005 Civic Si EP3

Sensors that ARE NOT compatible:

- 2005-2006 RSX Type S
- 2006+ Civic Si

Hybrid Racing Harness	RSX Secondary O2
PINK	Grey
WHT/RED	Black
BLK/WHT	White
BLK/ORN	White

For a guide on how to disable the secondary o2 sensor in the KPRO software, please go to the Hondata KPRO setup section of the guide.

PINK PIN 1
WHT/RED PIN 2
BLK/WHT PIN 3
BLK/ORN PIN 4



STEP 22: Hondata KPRO Setup Guide

This section will help you properly set up your Hondata KPRO to crank your car. While there are thousands of things the KPRO can do, we are going to briefly outline the few necessary steps to get your car up and running.

Before you begin

The Hondata K-manager software is **only** compatible with Windows based operating systems. Windows XP, Vista and Windows7 are all compatible with the K-manager software. You will need to have the ECU installed in the car, the conversion harness **MUST** be fully installed, and you must be connected to the ECU via USB in order to continue.

Step 1. Installing and connecting to the ECU.

At this point, the conversion harness should be completely installed. The battery should be installed and the car should turn on under its own power. Check all fuses and connections before plugging in the ECU then continue.

- Open the K manager software on your Windows based PC.

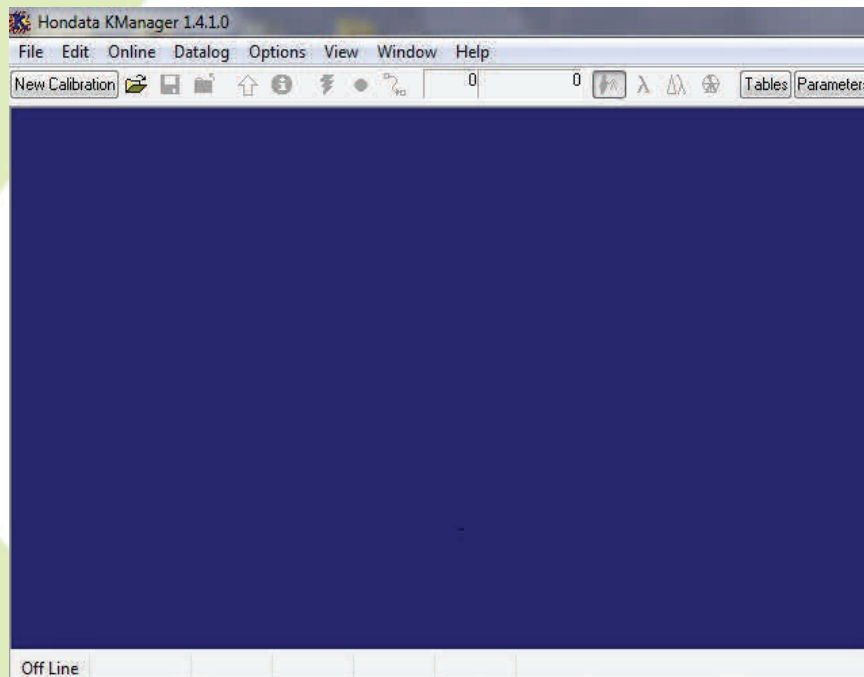

- The bottom corner of the screen will say, **“OFF LINE.”**

STEP22: Hondata KPRO Setup Guide page 2

- Connect to the ECU via the supplied USB cord.
- Once the ECU and PC are connected, the bottom left hand corner of the screen should read **“ON LINE, IGNITION OFF.”**
- If it does not read online ignition on, please update your USB driver, change USB port, change PC or use a different USB cord.

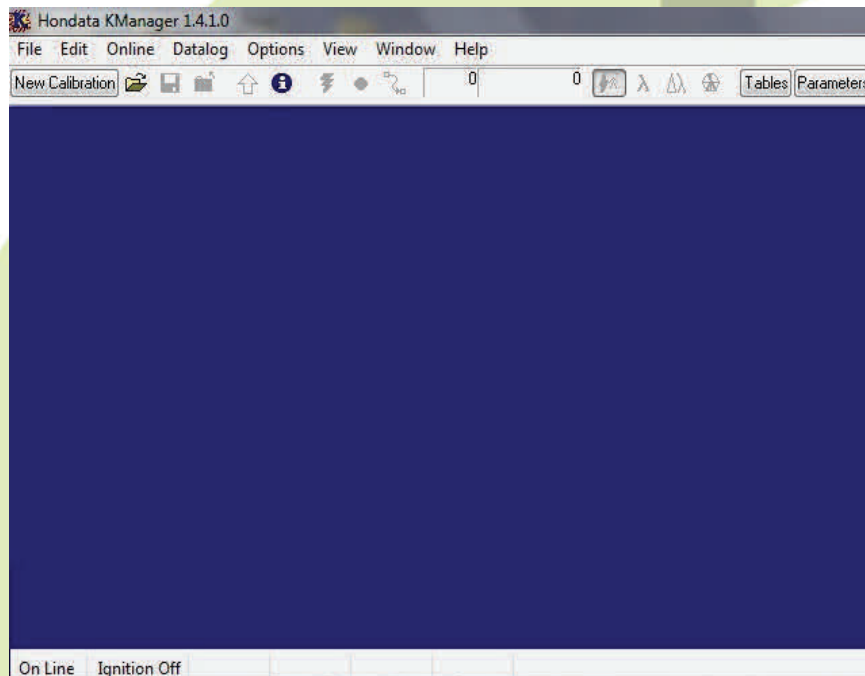

Step 2. Opening a calibration

- Turn the ignition to the ON position and check for connectivity at the bottom left hand corner of the K manager software.

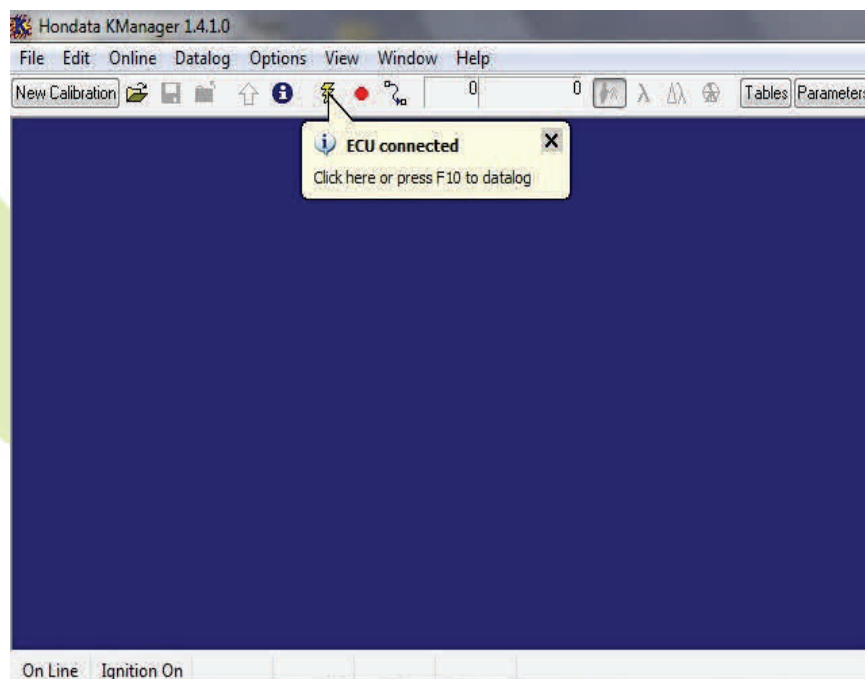

STEP22: Hondata KPRO Setup Guide page 3

- Once the ECU is connected to the PC, click on new calibration at the top left hand corner of the screen.

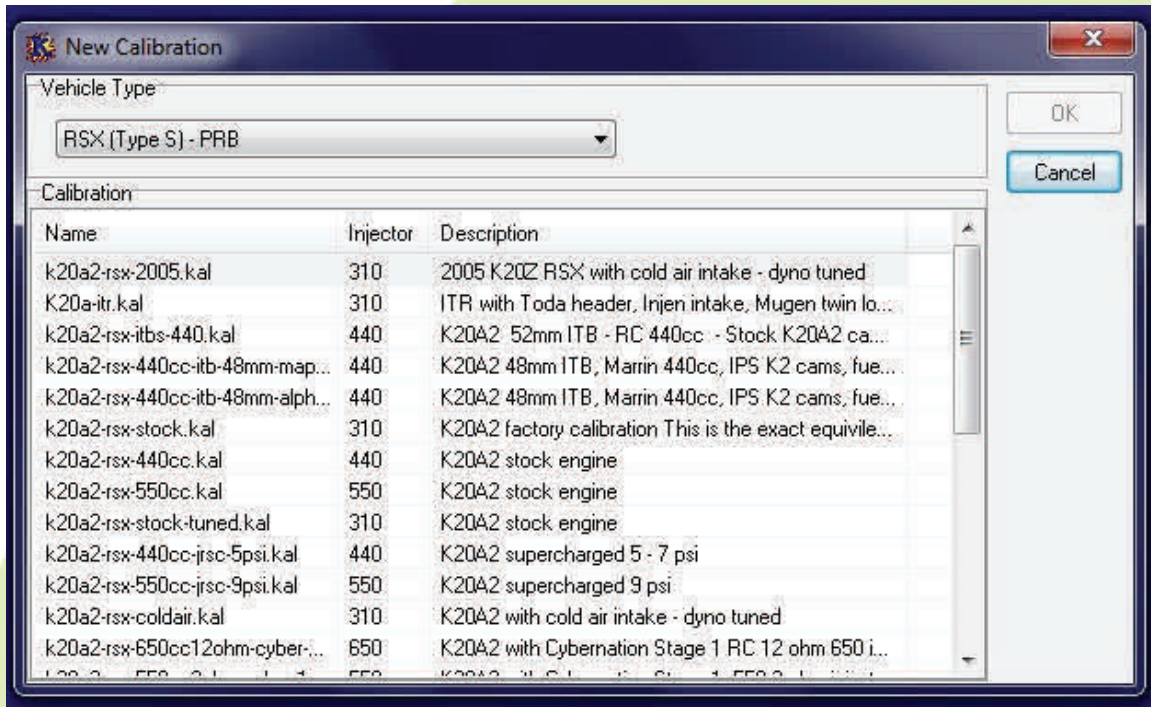

- What engine setup you have will determine what map you upload at this point. For the purpose of this guide, we will upload a stock calibration to a vehicle equipped with a K20A2 swap.

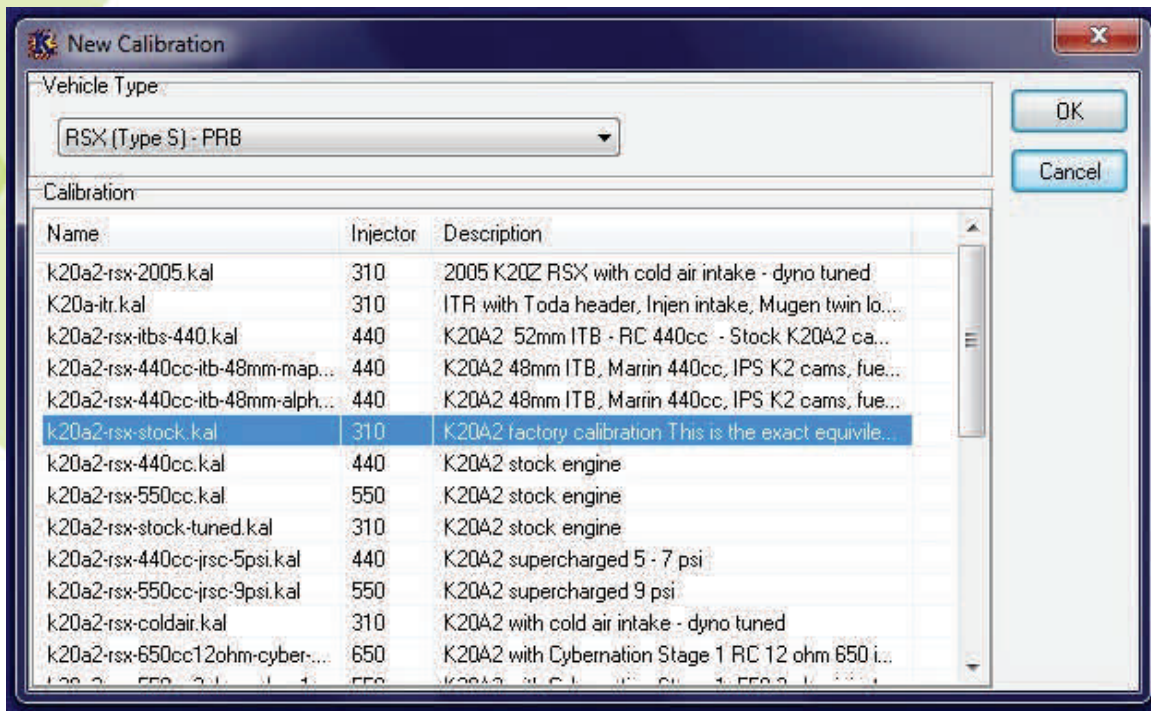

- Once you have selected the proper map, click the **OK** button and the box will disappear.

STEP22: Hondata KPRO Setup Guide page 4

Step 3. Making changes to a calibration

- Once a calibration has been opened, you can now edit the values and settings. Since we are focused on uploading a stock calibration, we will not cover the steps on how to tune the car. For more information on functions not listed, please refer to the Hondata software help guide.
- 1) Find and click the PARAMETERS tab at the top of the screen.
 - 2) Locate and click the MISC tab.

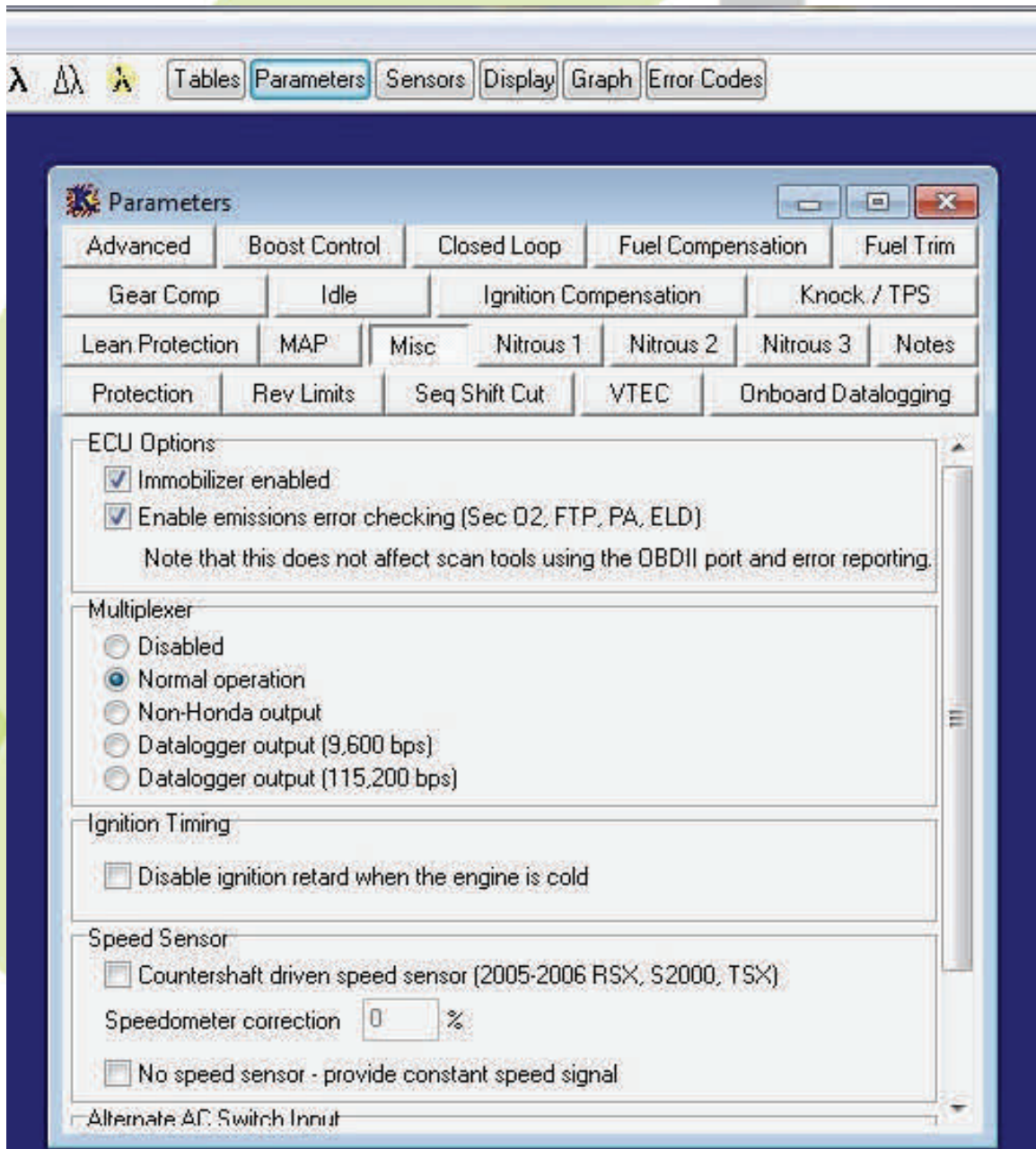

STEP22: Hondata KPRO Setup Guide page 5

- 3) Disable the Immobilizer
- 4) Disable Emissions error checking (this turns off the secondary o2 sensor, and other unnecessary sensors)
- 5) Disable the Multiplexer

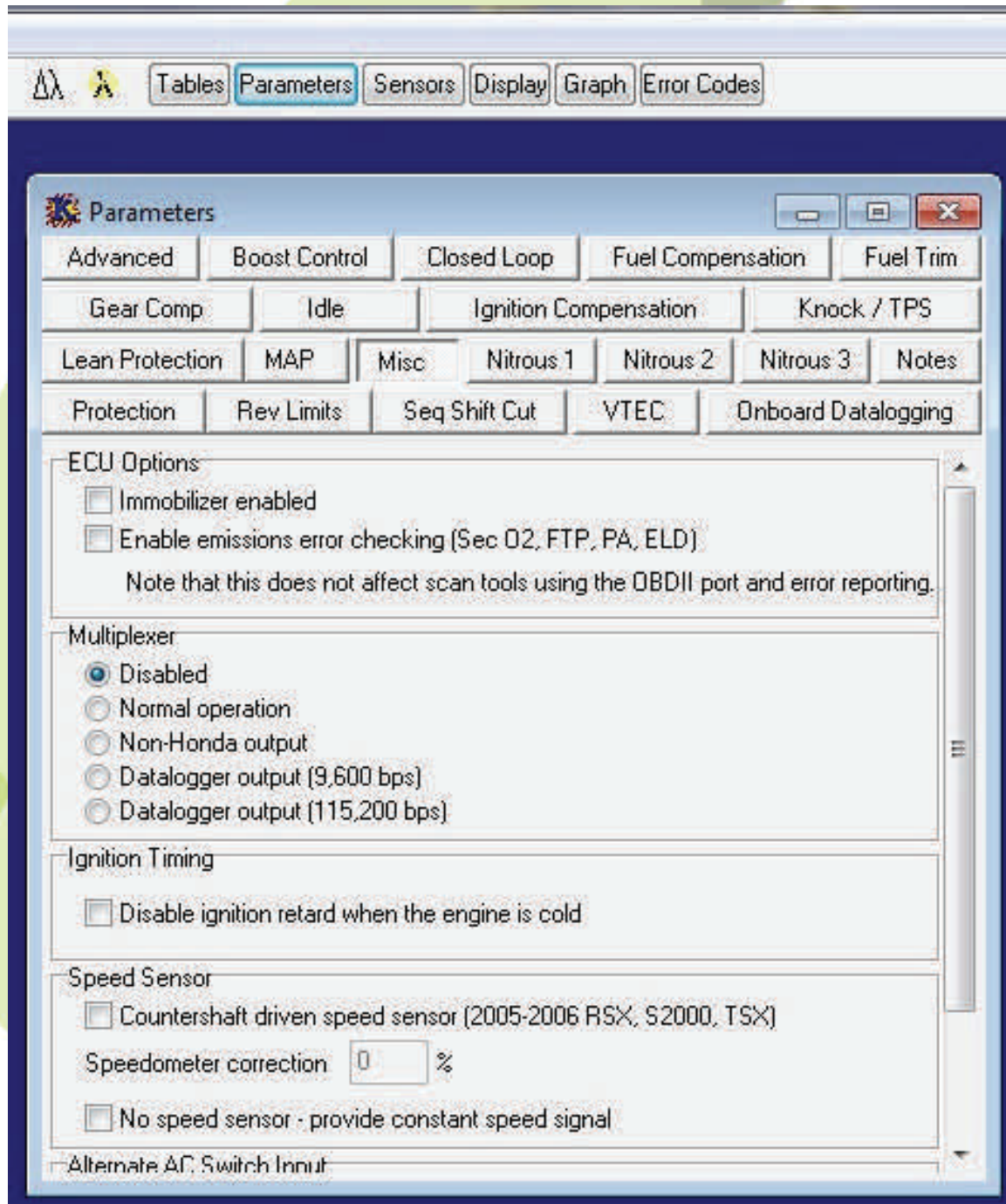

STEP22: Hondata KPRO Setup Guide page 6

Radiator Fan Control Setup

Now that you have made the necessary changes to the ECU to allow the car to start, you can now edit the fan (if you choose to do so.)

This step IS NOT NECESSARY If you have your fan wired to a switch, or if you are using the OEM fan switch, disregard this step! This is only for those wishing to allow KPRO to turn the fan on by a set temperature.

- 1) Locate and click the **Protection** tab.
- 2) Under the Overheating Protection heading, you may edit the temperature at which the cooling fan will turn on. The factory setting is 204*f, if you are running an OEM, or half size radiator, setting the temperature lower to around 185*f may help cool the car better.

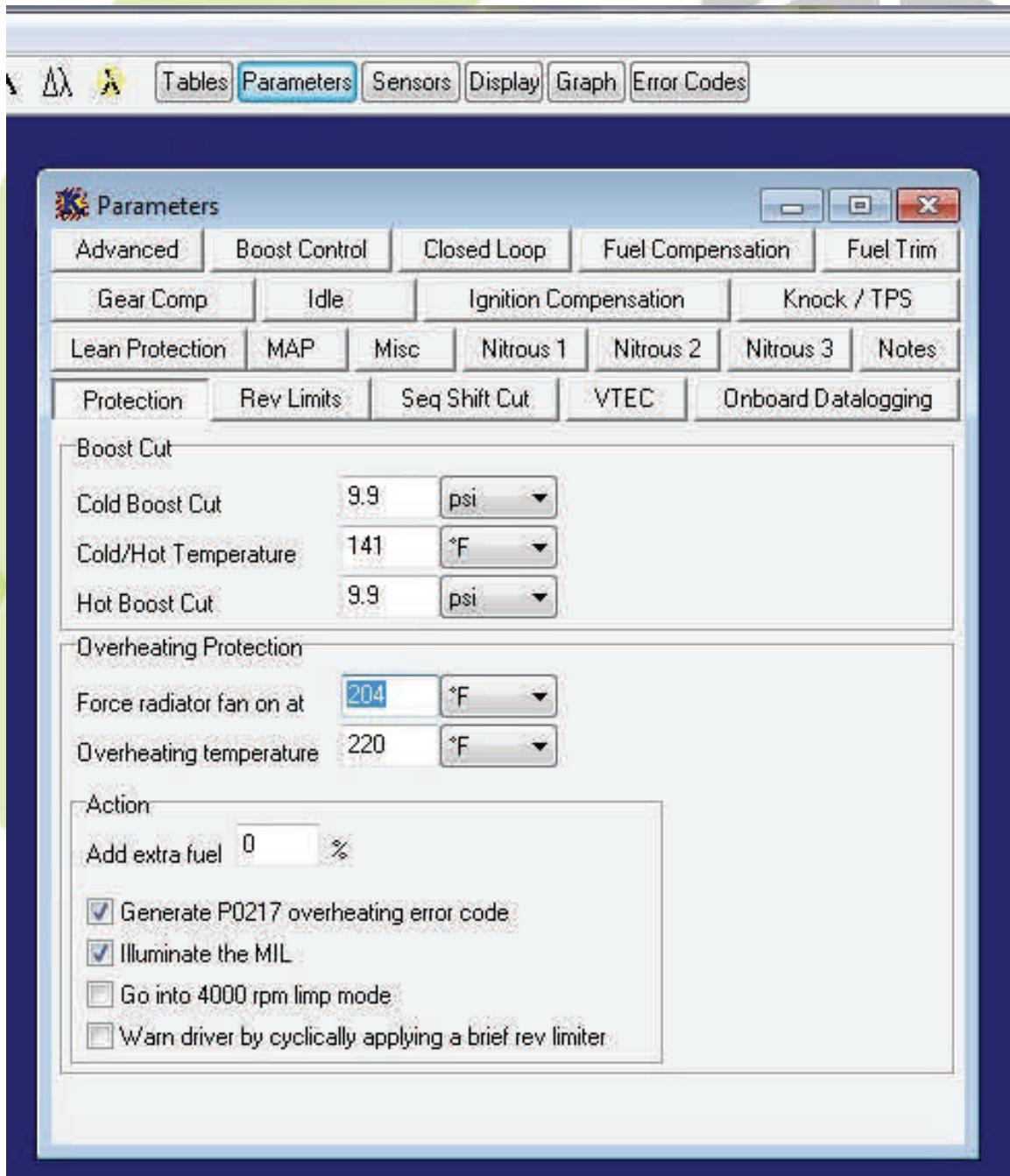

STEP22: Hondata KPRO Setup Guide page 7

Step 4: Uploading changes to the ECU

- 1) Once you are finished editing the ECU settings, you are now ready to upload the changes to the ECU.
- 2) Locate the UPLOAD button, located near the top left corner of the screen.

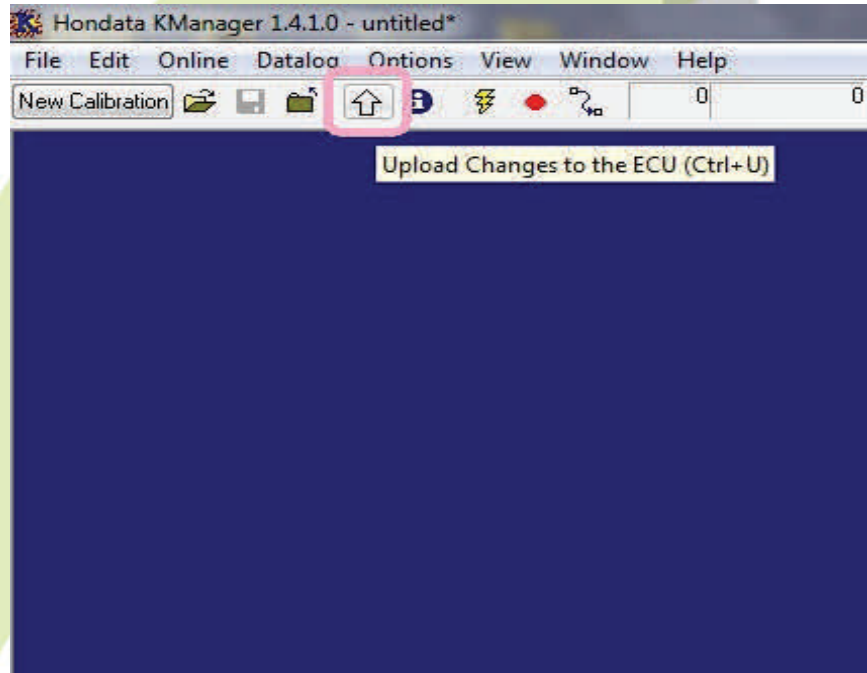

- 3) Click the UP arrow and the changes will be reflashed to the ECU.

**It is important to note that the fuel pump will turn on when the changes are uploaded. Once the upload is finished, it will prime again. If you do not hear the fuel pump turn on when you upload changes, please check the fuel pump control wires on the conversion harness.

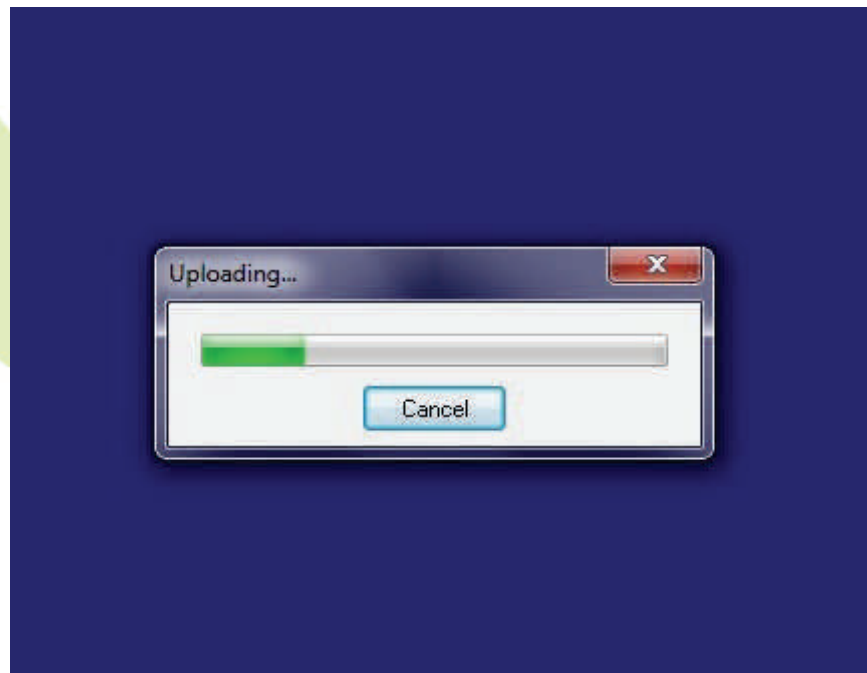

STEP 22: Hondata KPRO Setup Guide page 8

Step 5: Data logging & Error codes

- 1) The K Manager software can data log and display sensors in real time.
- 2) To datalog, find the and click the LIGHTNING BOLT button near the top left hand corner of the screen.

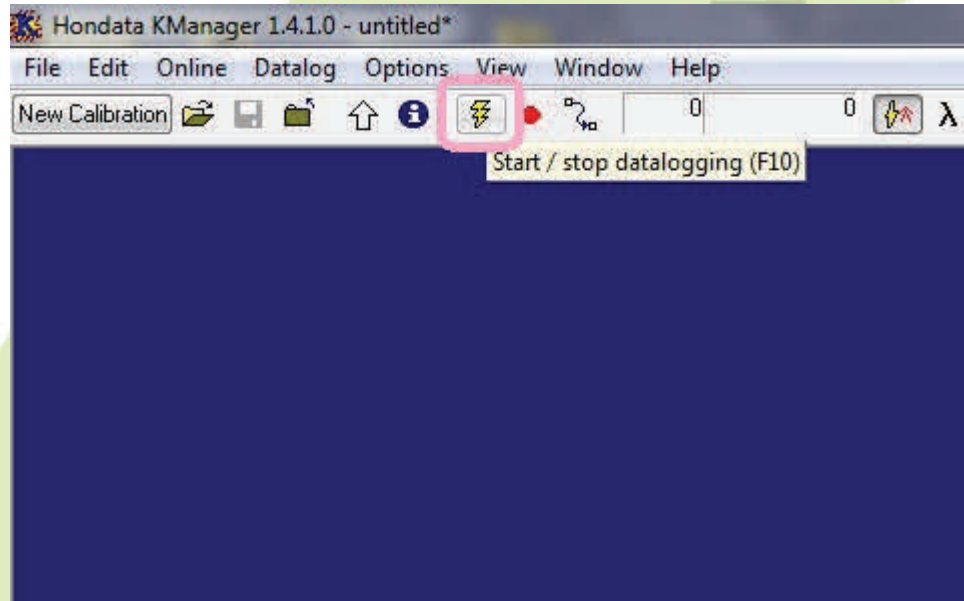

- 3) Once you click the datalog button, you will be notified if there are any errors with the system.
- 4) Find and click the ERROR CODES tab near the top right of the window. If you have any error codes a small box will pop up.

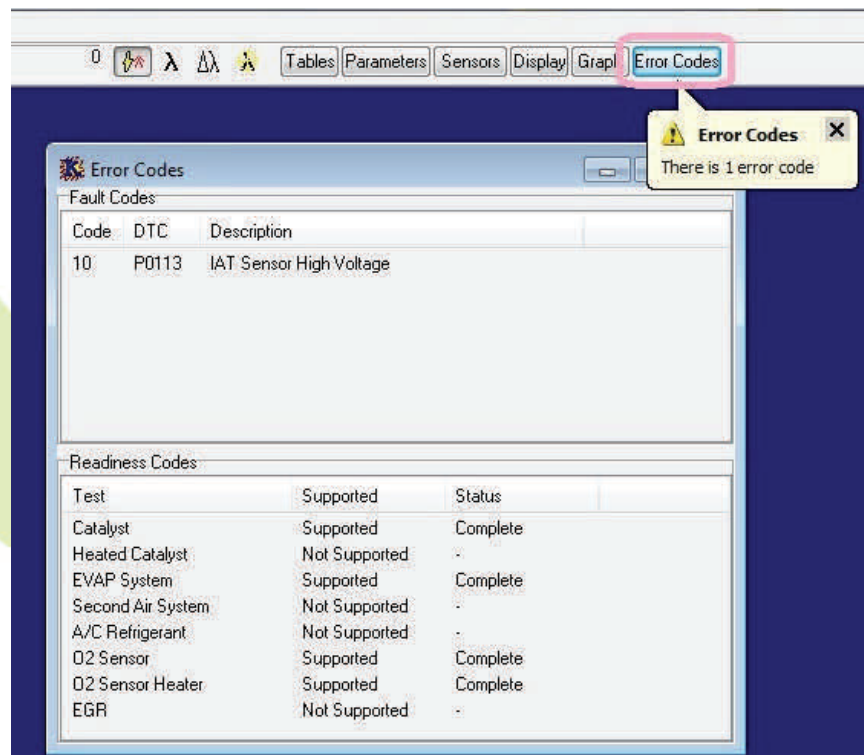

STEP 22: Hondata KPRO Setup Guide page 9

- 1) The error codes will tell you what is going on with the system.
- 2) Once the errors have been fixed, or to check if they have been fixed, you will need to clear the DTCs.
- 3) Find the ONLINE tab in the upper left hand corner of the screen.
- 4) Click CLEAR DTCs.

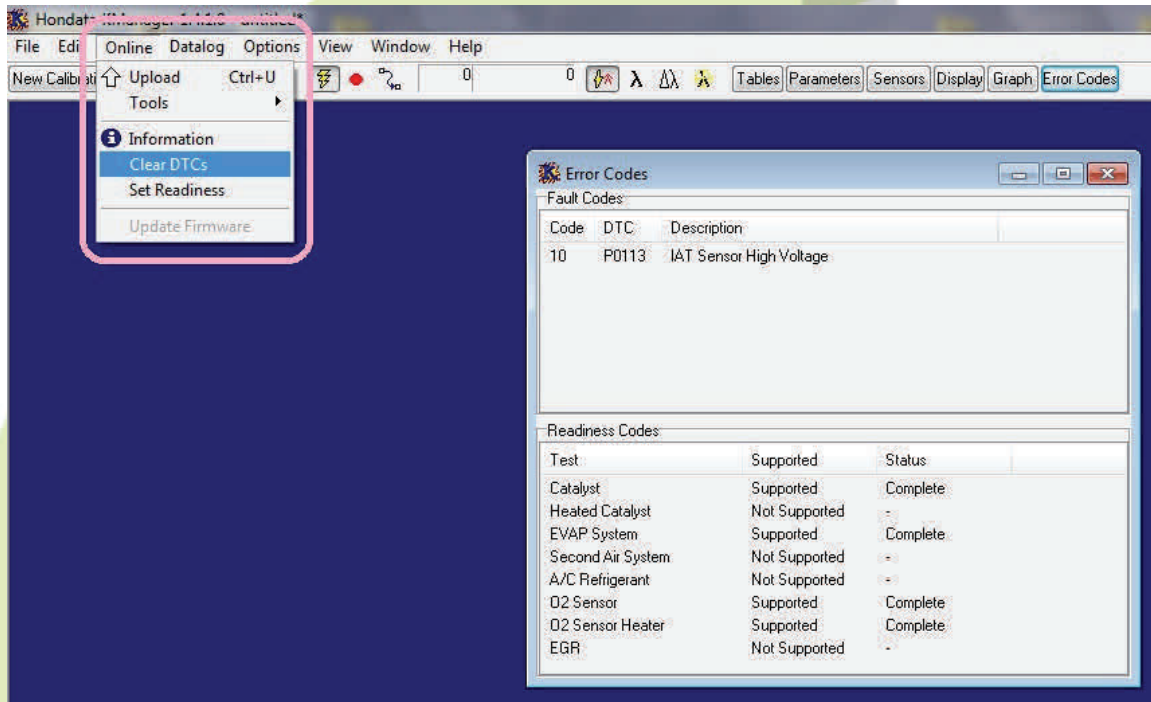

- 5) Once you clear the DTCs the error codes box will be empty if the error has been fixed. If the code still remains, please continue to try and fix the errors.

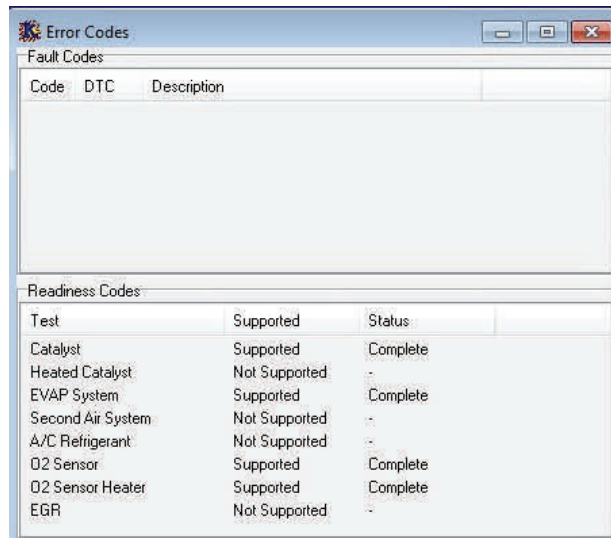

Trouble Shooting and FAQ's

As stated in the introduction section, this harness requires the use and handling of electricity and electrical components. When trouble shooting or dealing with electrical wires, assume every wire has power and the potential to cause a short or fire. If you are not familiar or comfortable with wiring, please involve the necessary professionals to trouble shoot a problem. **User error is one of the leading reasons why electrical problems occur.**

Below you will find some frequently asked questions and trouble shooting tips please read over them so you are aware of potential problems that might come up during your installation.

Tools needed to trouble shoot:

- **Digital Multi-meter**
- **Appropriate wiring manuals and guides**
- **Wire snips and strippers**
- **Electrical tap**
- **Friend or another set of hands**

“My fuel pump doesn't come on!?”

How the circuit works!

The fuel pump is controlled by the ECU. With the immobilizer disabled, the ECU will output the ground signal through E1, into the OE chassis wiring that you connect and into the Main relay. This will in turn switch the fuel pump section of the relay over, sending 12v to your fuel pump turning it on.

WHAT IF WE ACTUALLY INCLUDE THE SCHEMATIC FOR THE EG MAIN RELAY AND DC MAIN RELAY HERE OR AS APPENDIX AT THE END OF THE DOCUMENT.

In order to make the fuel pump come on, you have to check a few things:

If you have a KPRO:

- 1) Make sure the wire coming out of E1 connected to the appropriate place. Look over page(s) 8 for the proper connections.
- 2) Make sure you have the Immobilizer disabled in the KPRO software. Look over the “Hondata Setup Guide” for more information.
- 3) If you have disabled the Immobilizer in KPRO and you know the connection is correct and solid, check for Ground at E1 when you turn the key to the ON position. The ECU will output a Ground for a few seconds then shut off. If you have no Ground at E1 as mentioned above it is highly likely that you have a damaged ECU.
- 4) To confirm this you can install the ECU into another running car and redo the above test. If you do not have access to another chassis or another ECU you will need to contact HONDATA at 310-782-8278 to have the ECU diagnosed. There is generally a \$150 charge for diagnostics by HONDATA.

If you DO NOT have a KPRO:

- 1) No KPRO means the ECU isn't going to be grounding the fuel pump section of the main relay. In order to make it come on, you have to ground that part of the relay yourself.
- 2) Make sure you have the fuel pump wires on your OEM ECU A connector grounded to the frame properly **as outlined in section 7,8 and 9 below.**
- 3) If you have them grounded and it does not come on, check the main relay for damages or replace it with a known good unit.



Trouble Shooting & FAQ's cont'd

"My car doesn't crank when I turn the key on!?"

How the circuit works!

Your engine has a starter that gets its power from the battery. The motor has to be grounded in order for the starter to engage. If you do not have grounds on the engine, the starter won't do anything.

WE SHOULD INCLUDE WHAT WIRES THEY NEED TO CHECK FOR THE STARTER SIGNAL WIRE HERE. WE MIGHT ALSO WANT TO INCLUDE A SCHEMATIC FOR THEM TO REVIEW.

- 1) Make sure you have the proper engine grounds. You need a total of (at least) 3. Review our ground kit if need be.
- 2) Check all of your fuses. There is a fuse box under the dash and in the engine bay, make sure they are all good.
- 3) If all of your grounds and fuses are good, check the ignition switch and necessary wiring. You can also check the clutch pedal switch and starter relays for activity.

"I get a P0600 when I check for error codes!?"

How it works!

DC5 and all later OBD2 B cars have what Honda calls a "Multiplexor." The device is located inside of the DC5 fuse box and allows sensors to send multiple digital signals through the same wire. Since this unit is NOT in the EG/DC/EK it does not work.

****Important information****

- You will get a P0600 code with a JDM K20A ECU
- Hondata KPRO allows for the "Multiplexor" to be disabled
- Hybrid Racings immobilizer removal box will disable P0600

- 1) This stored error code WILL NOT affect performance, however it cannot be erased with the stock ECU.
- 2) It will be present if you connect a data port scanner to it, you will not be able to pass OBD2 port emission scans with this code.

"My fans don't kick on!?"

How the circuit works!

You must connect your radiator fans to the OEM wiring inside of the engine bay. **If you do not do this, they will not work.** The fans get power from the fan relay inside of the fuse box, and the fan relay gets power from the fuse box and a ground from the fan sensor switch (or KPRO.) If you want to wire your fans to a switch, feel free, however make sure you understand how the circuit works and how much amperage is required to run them.

IF THEY ARE RUNNING A RHI THEY SHOULD MAKE SURE THAT IT IS GROUNDED. MAKE SURE THAT THE RADIATOR IS GROUNDED. WE SHOULD INCLUDE A SCHEMATIC FOR THIS AS WELL.

- 1) Make sure the fans are connected to the OEM fan control wires in the engine bay.
- 2) Ensure the wire labeled "FAN SWITCH" is connected on the conversion harness.
- 3) Ensure the other wire coming out of the fan switch is grounded to the frame.
- 4) If you are controlling the fan VIA KPRO, make sure the value is set to the appropriate temperature.
- 5) If the fan(s) still fail to turn on, trouble shoot the fan relay inside of the fuse box and check all connections to the fans themselves.

Trouble Shooting & FAQ's cont'd

"My coolant gauge doesn't work!?"

How the circuit works!

The EG/DC gauge cluster doesn't understand what the K20 coolant temp sensor is saying. In order for the OEM gauge cluster assembly to work, the OEM sensor needs to be installed in the coolant system.

****Important information****

The coolant temp sensor can NOT be used in the lower radiator hose. Cool coolant flows through the lower hose on it's way to the thermostat. If the sensor is installed in the lower portion of the hose, it will NOT read correctly. (Because it is reading from COLD coolant)

- 1) Make sure you have the sensor located in an appropriate place. (i.e. HR swap radiator, or water neck housing adapter)
- 2) Make sure the conversion harness wire labeled "COOLANT TEMP" is connected to the sensor.
- 3) If installed into the HR swap radiator, make sure the radiator is grounded.
- 4) If installed into the water neck housing adapter, make sure the engine has proper grounds.
- 5) If the gauge fails to work, ground the wire on the HR conversion harness and see if the gauge goes all the way to "HOT." If not, contact HR for further trouble shooting.
- 6) If the gauge shoots to "HOT" replace with a known good coolant temp sensor.

HYBRID RACING

"My speedometer doesn't work!?"

How the circuit works!

The K series speed sensor is located on the transmission case and gets its power and ground from the engine wiring harness. When the car moves, the speed sensor gear spins, outputting a pulse. That pulse is transmitted through the engine wiring harness to the ECU and gauge cluster assy. Our conversion harness takes that signal and brings it to the gauge cluster.

If you have a K20Z1 or K20Z3 transmission you MUST use the HR speedo converter. Otherwise you speedo will not work and VTEC will not be functional.

"My car runs, but idle surges!?"

How it works!

On the bottom of the throttle body there is an idle air control valve (IACV) which lets air into the engine to idle the car up when the engine is cold. In some cases, the valve can get stuck open or closed which will result in an idle surge. The surge can be small or large depending on how the valve is positioned. This will account for nearly all idle surge problems the K motor can have.

- Locate and unbolt the throttle body
- Remove the bottom screws that hold the IACV to the throttle body housing
- Separate the idle valve (black plastic piece) from the metal housing
- Clean the valve until it spins freely by hand.
- Reinstall and connect the coolant hoses

Trouble Shooting & FAQ's cont'd

"I have a P1166, or P0134 and my A/F sensor doesn't work!?"

How it works!

K series motors are extremely affected by the A/F ratio sensor, if the primary A/F sensor is not connected, it will affect performance and fuel economy. These error codes are related to the primary o2 sensor and are common when the sensor is either not present, connected improperly or if the proper sensor is not present.

****Important information****

Only the sensors that will work properly for this function will come from the 2002-2004 RSX Type S, or 01-05 JDM DC5 Type R. NO OTHER OEM SENSOR WILL WORK.

- 1) Make sure you have the correct o2 sensor installed into your exhaust system. *Running open headers CAN affect how the o2 sensor reads. Please install at least 12" of pipe after the o2 sensor.*
- 2) Check and insure the o2 sensors are connected to the proper wire on the HR conversion harness.
- 3) If the o2 sensor is connected and still fails to read, and the error codes remain, remove the sensor and install it into a car that has a working o2. If the sensor gives the error code in that car, replace or change the sensor. If no error code is present, call us for more trouble shooting tips.

If your o2 sensor reads, but reads incorrectly, (i.e. lean readings, ect) please call us for other trouble shooting tips.

"My car turns over, but doesn't crank and run!?"

How it works!

Engines need three basic things to have them run. 1) Compression, 2) Fuel, and 3) Air.

Start by checking the 3 basic functions first.

- 1) Remove the spark plugs for inspection.
 - If the plugs are wet with gas, we can assume the fuel injectors are firing.
 - If they are dry, assume fuel injectors are NOT firing.
- 2) Ground the spark plug tip to the valve cover and install it into a coil pack. Have someone turn the car over. Check for spark.
 - If yes for fuel and spark, check timing or compression.
 - If no spark or fuel, check ECU. (
 - If fuel and no spark, check ECU. (make sure to load a map in KPRO and connect conversion harness wires properly.)
 - If spark and no fuel, check ECU. (common with JDM Type R computers)
- 3) The ECU controls the fuel and the coils. If you have a JDM Type R computer, you must ground the fuel pump relay. This is outlined on pages 9-13 of this guide.

95% of cranking issues is related to the ECU. Please make sure you have everything connected and you have all of the necessary immobilizer removal functions in place to continue.

If problems still exist, please contact us for further trouble shooting tips.

If you have any questions or comments, please email info@hybrid-racing.com
or call us at 225-932-9588

Legal Disclaimer

Users assume all cost and risk associated with these or any other items purchased from Hybrid Racing LLC.

Parts sold or manufactured by Hybrid Racing LLC may not meet legal requirements for use on public roads. People thinking about purchasing product(s) from Hybrid Racing LLC should check with their local and state authorities for legality. It is the user's responsibility to know and comply with all local and federal laws and regulations. Use or installation of Hybrid Racing LLC products may affect user insurance and/or vehicle warranty coverage. It is the user's sole responsibility for consequences that may occur due to having the product installed in his/her vehicle.

Hybrid Racing LLC assumes no legal responsibilities and/or liabilities, whether to user's vehicle, engine, person(s), and/or property(s), that result from the use of, or servicing of a vehicle of which a Hybrid Racing LLC product has been installed/attempted to be installed, or to any other vehicle(s) and/or person(s), regardless of whether or not this product has any involvement directly or indirectly and/or liability, and/or whether or not proper installation has been carried forth.

All engines, engine parts and electrical components are for OFF ROAD USE ONLY/
RACING
VEHICLES ONLY. They are not for or to be used on public roads in the USA.

Acquisition of a Hybrid Racing LLC product will act as an acknowledgement of the legal disclaimer stated herein.

Hybrid Racing LLC reserves the right to change this disclaimer at any time without any prior consent or notification.

Should you need to contact us our details are as follows:
Hybrid Racing LLC, 12231 Industriplex Suite B, Baton Rouge, LA 70809
www.hybrid-racing.com