

## Montageanleitung

# SiSi

# Massivholzbett

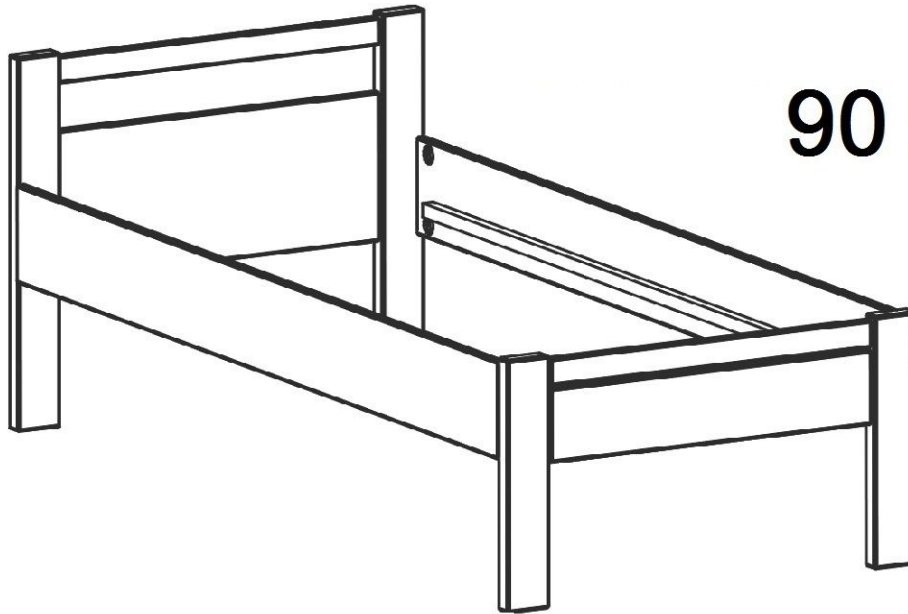

## 90 x 200 cm

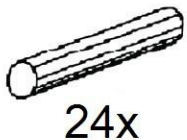

24x



16x



16x



16x



16x



16x

Zur Verbindung der Seitenteile mit dem Kopf- und Fußteil sowie für die Befestigung des Mittelholms am Kopf- und Fußteil.

**Wichtiger Hinweis**  
Important information  
Belangrijke informatie  
Information importante

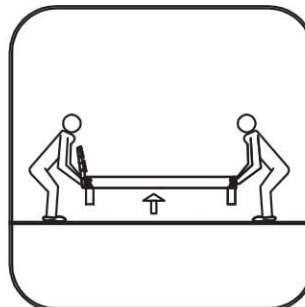

Bett nicht verschieben.  
Nur angehoben verstellen.  
Move not only raises  
bed adjusted.  
Bed niet verschuiven,  
men moet het bed ophe-  
verplaatsen.  
Ne pas ousser le lit,  
il faut le porter pour deplace

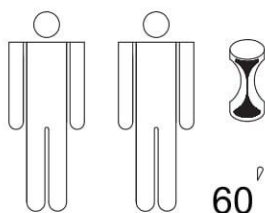

60<sup>p</sup>





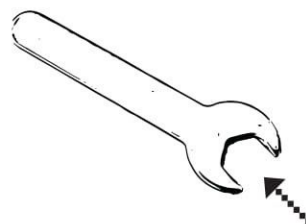



Bitte keinen elektrischen  
Schrauber verwenden!

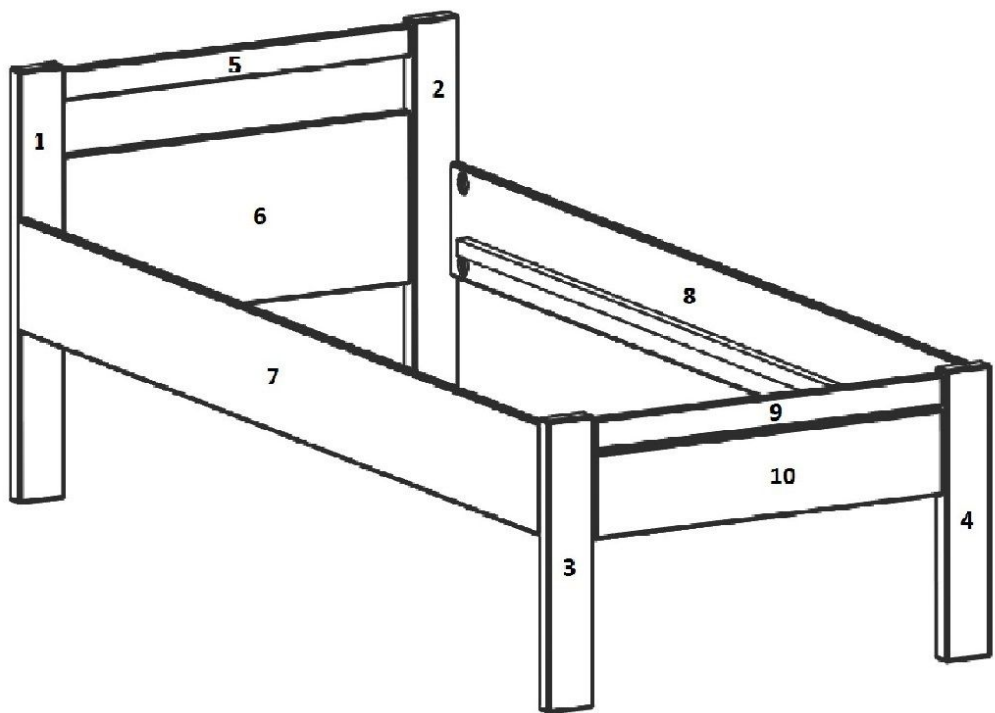



Benötigtes Montagewerkzeug im Lieferumfang

# 1



- A 
- B 
- C 
- D 
- E 
- F 

A  x16  
D  x24



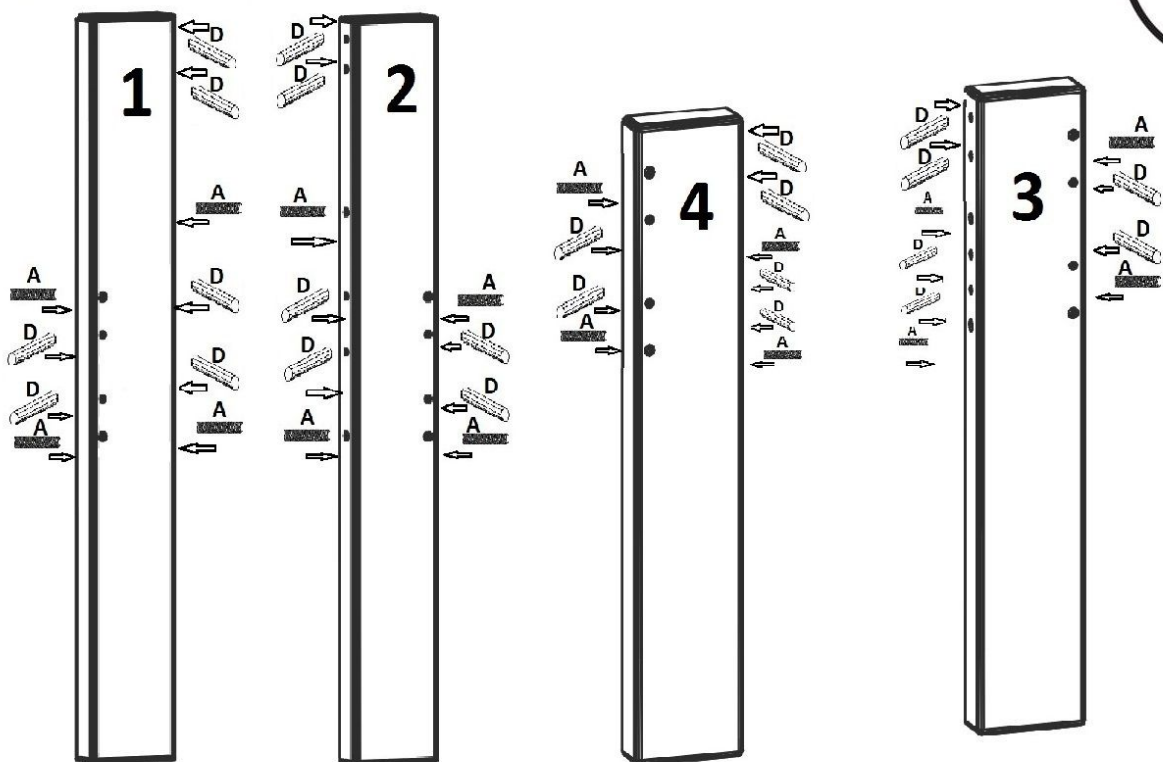

# 2

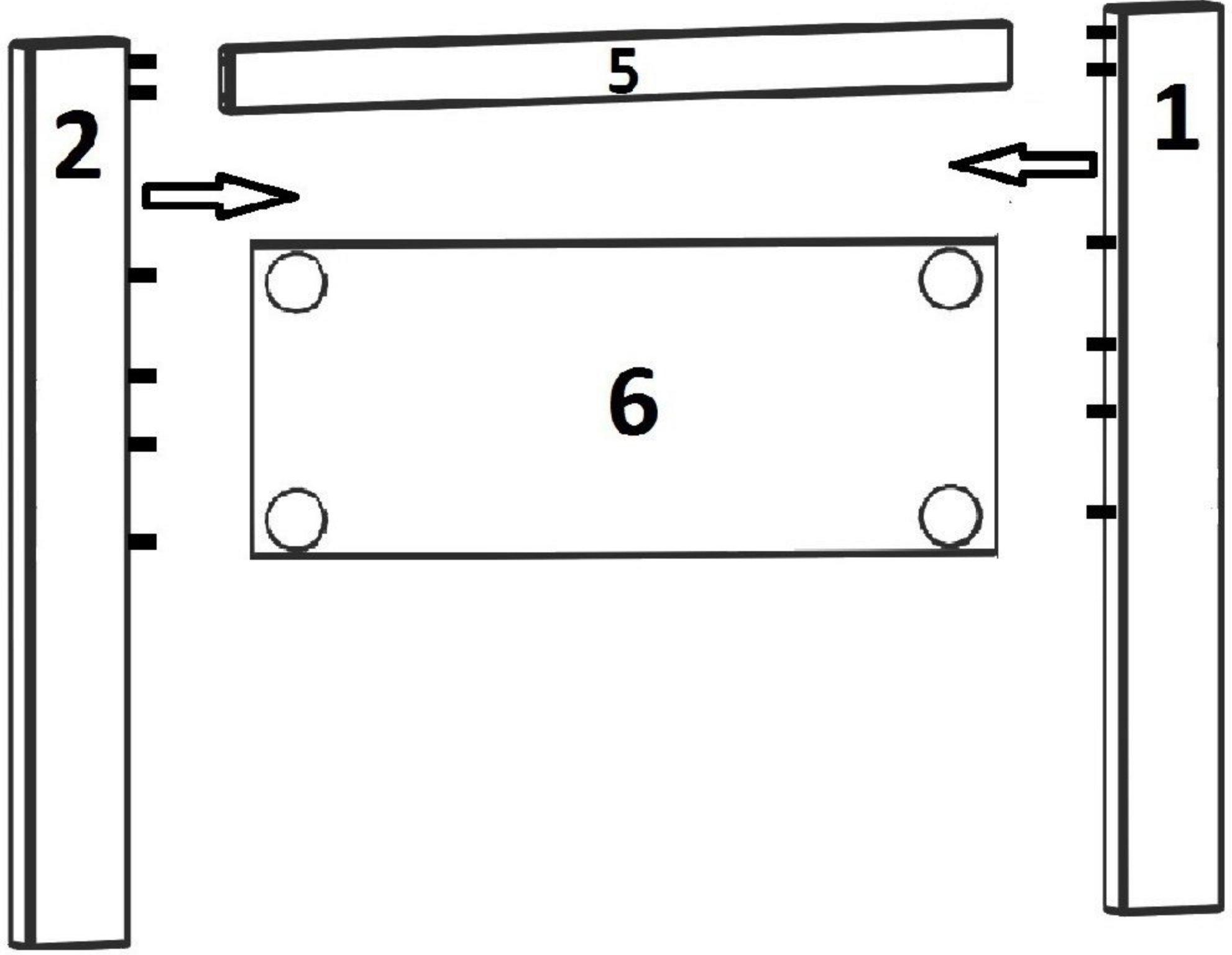

3



4

- B  x 4
- C  x 4
- E  x 4
- F  x 4

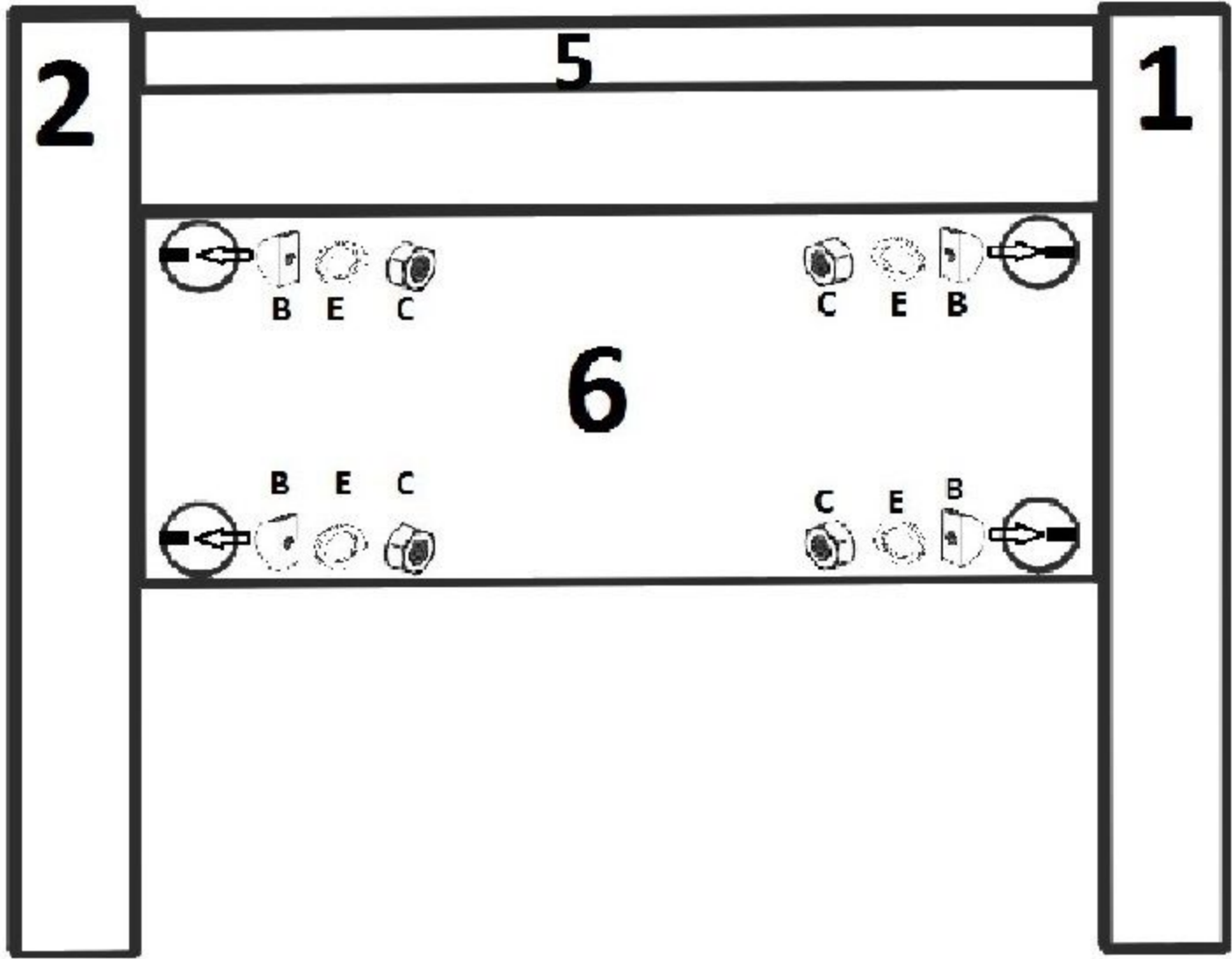
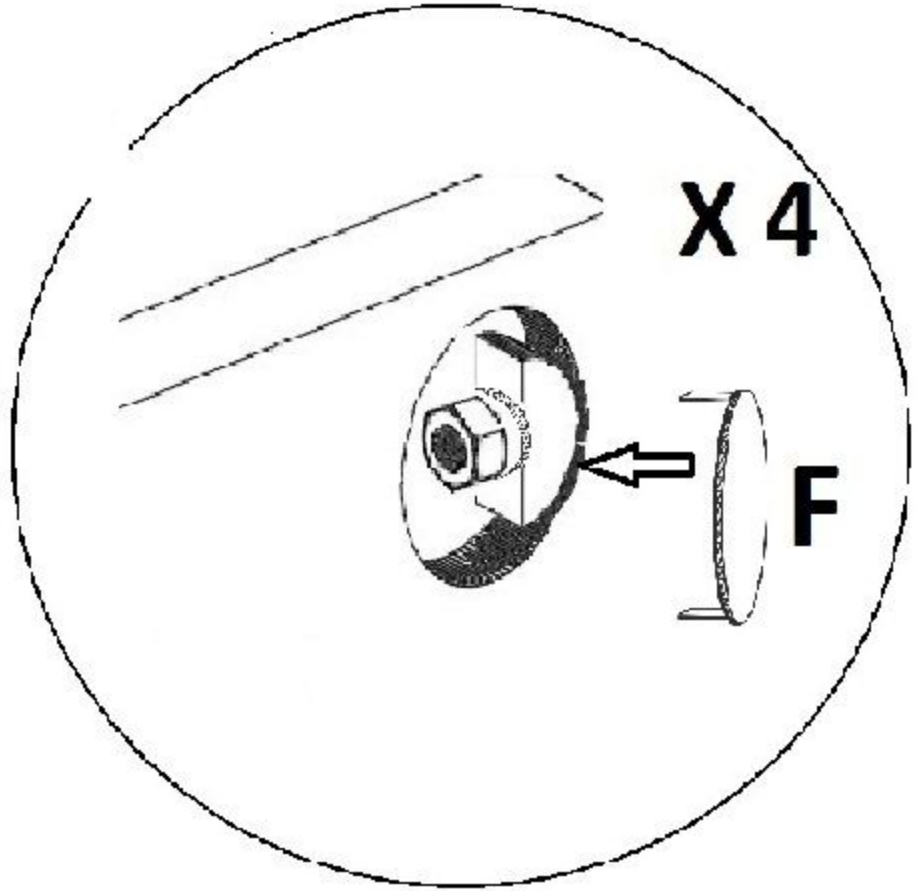
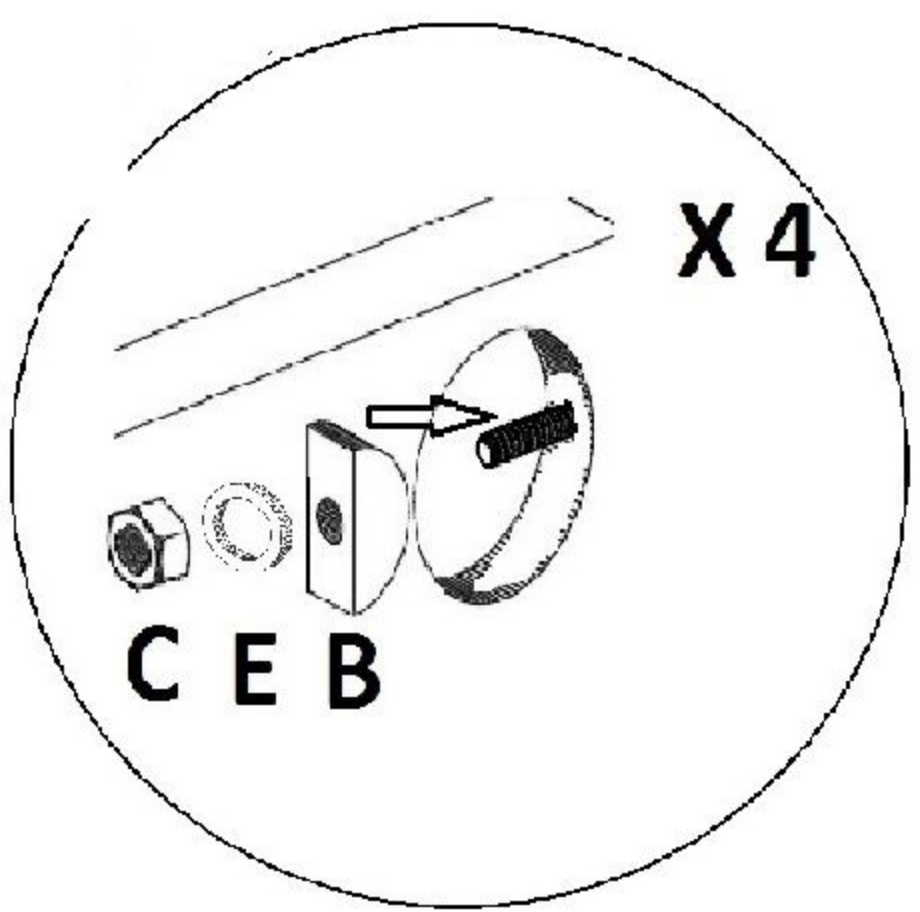



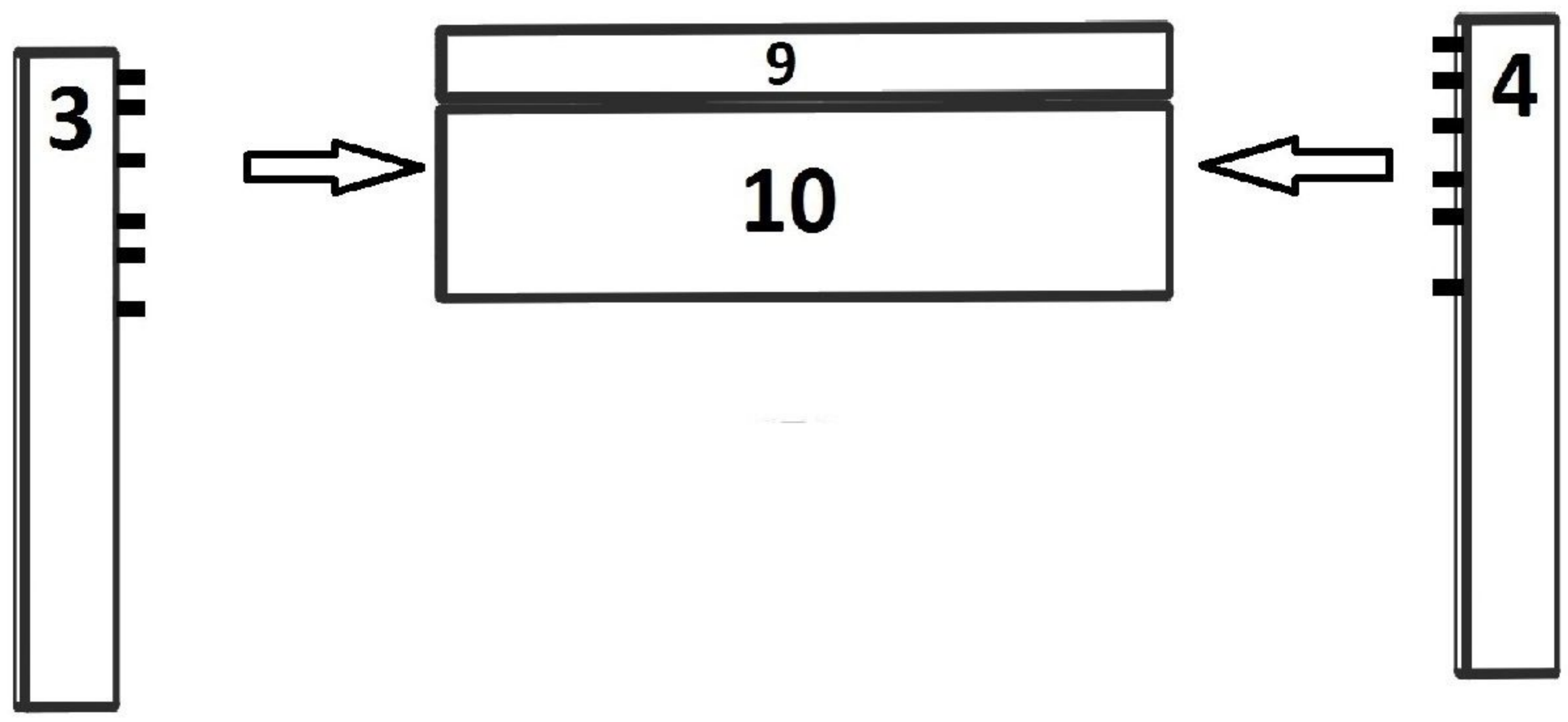

5

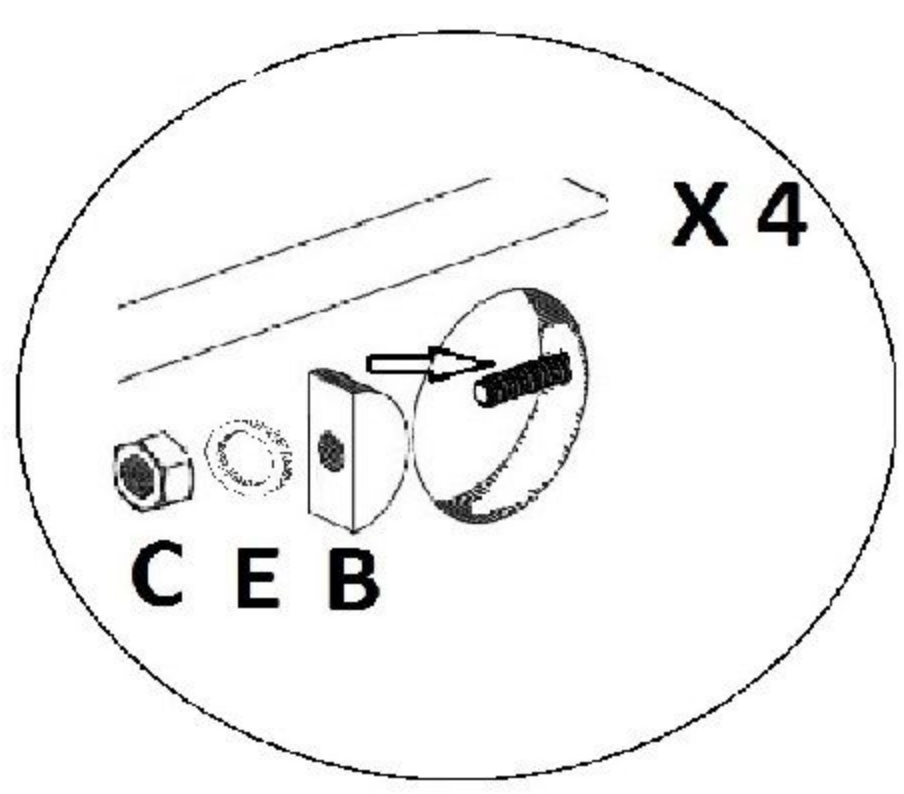

6



- B**  x 4
- C**  x 4
- E**  x 4
- F**  x 4

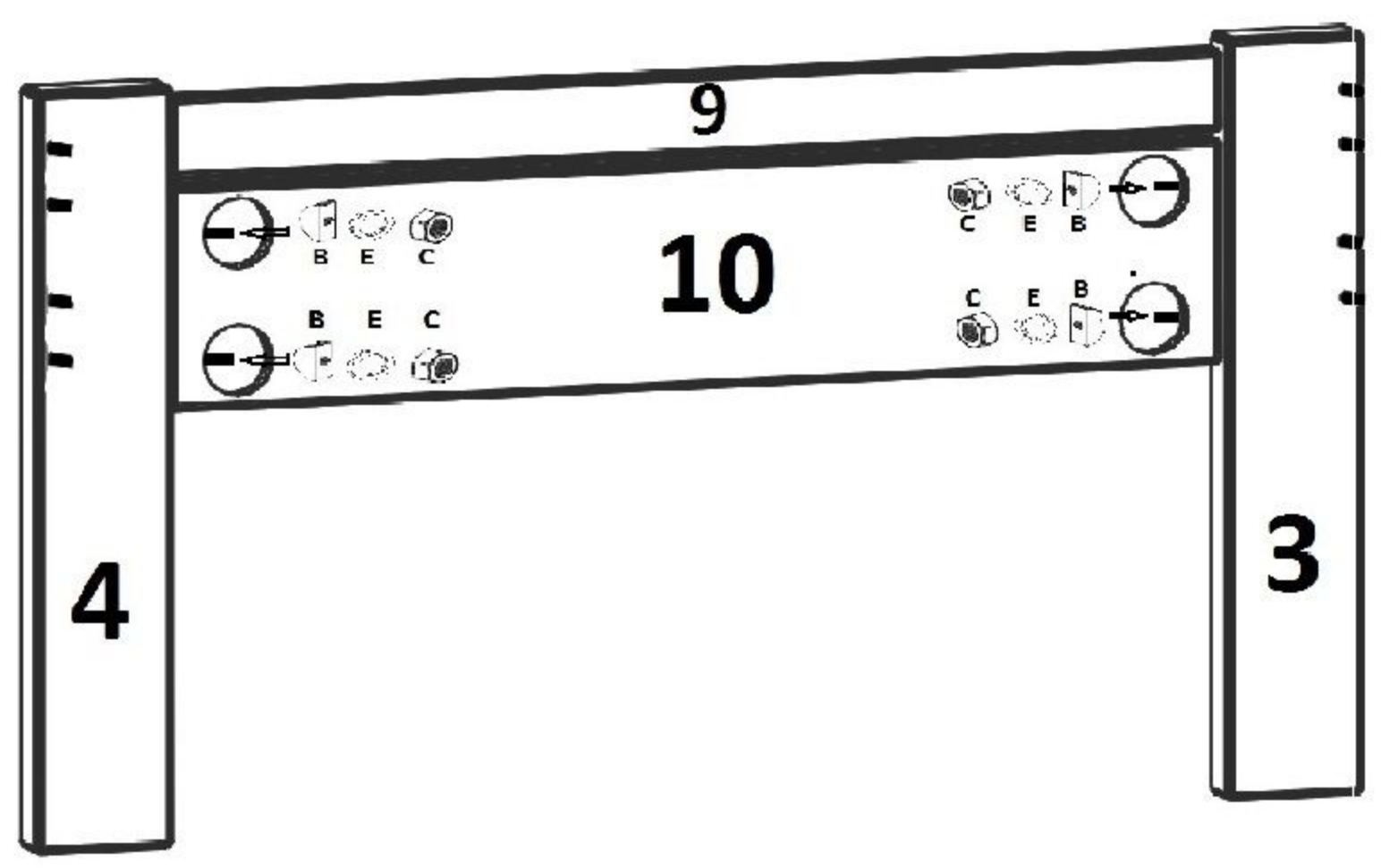
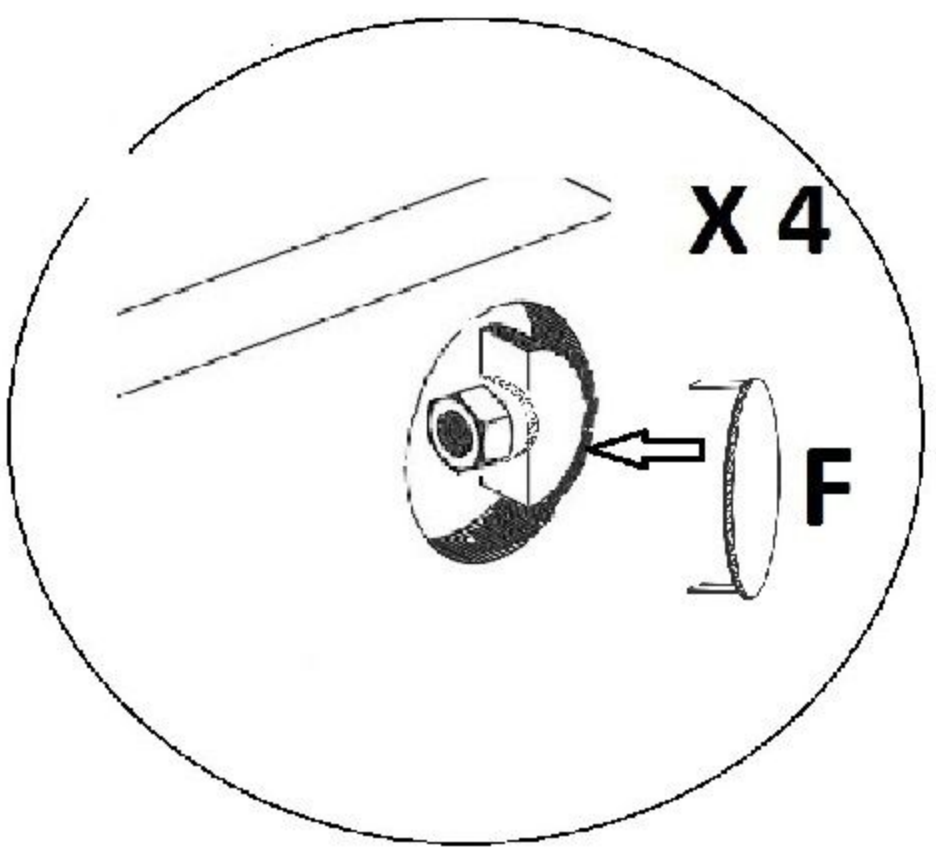



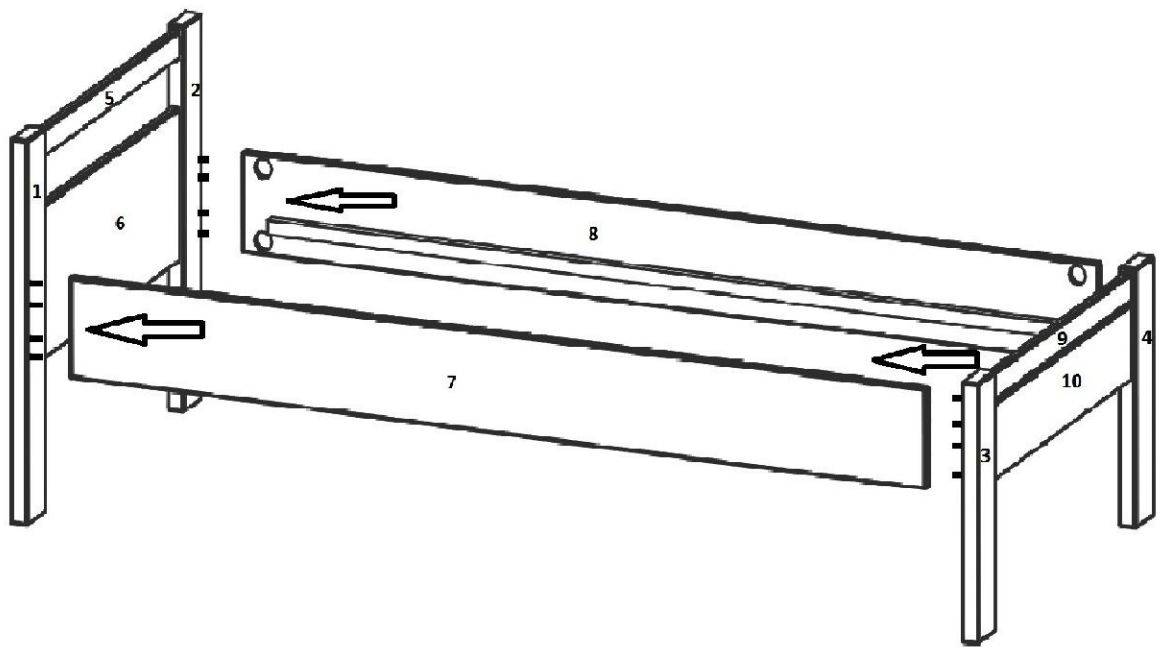

# 7

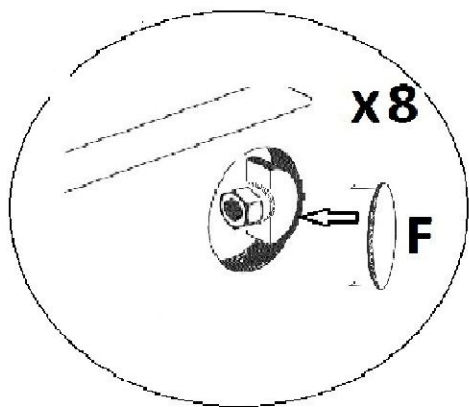
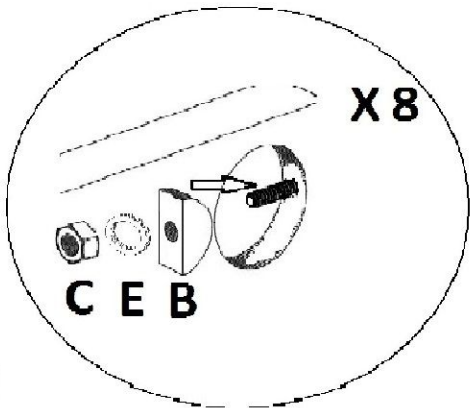

# 8



- B**  x 8
- C**  x 8
- E**  x 8
- F**  x 8

