

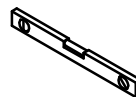

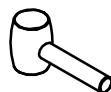

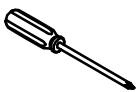

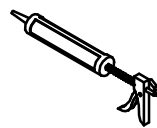

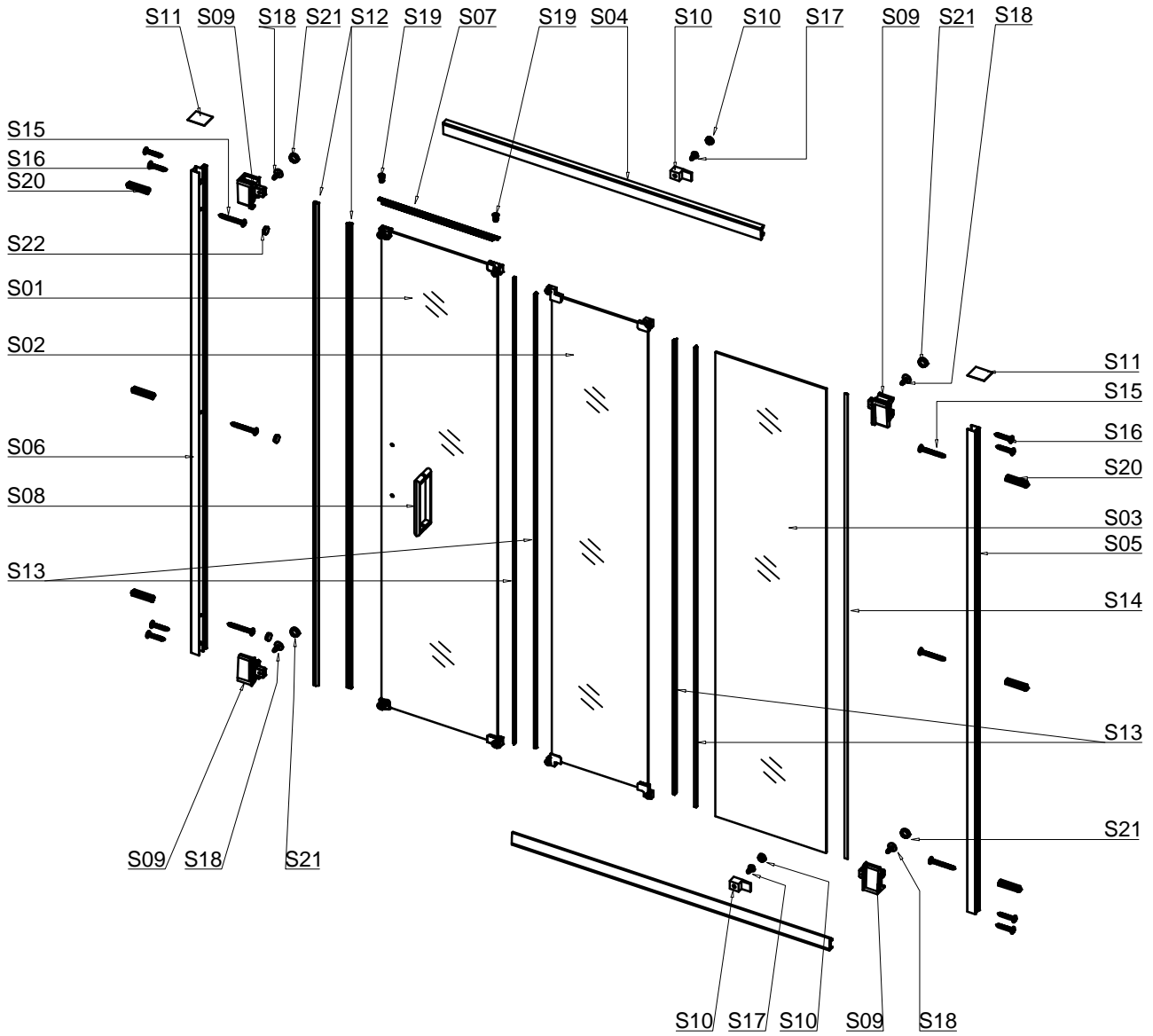
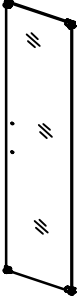

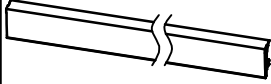



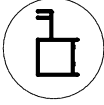



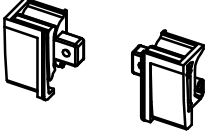
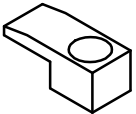



ATSL series

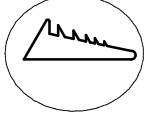
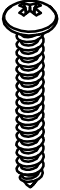
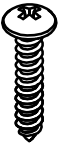

S01 1PC 	S02 1PC 	S03 1PC 	S04 2PC  	S05 1PC  
S06 1PC  	S07 1PC  	S08 1PC 	S09 4PC 	S10 2PC 
S11 1PC 	S12 2PC  	S13 4PC  	S14 1PC 3.0mm  	S15 8PC ST3.9x40 
S16 8PC ST3.9x20 	S17 2PC ST3.9x8 	S18 4PC ST3.9x12 	S19 2PC M3.9x8 	S20 8PC Ø6 
S21 7PC 10mm 	S22 2PC 8mm 			

R

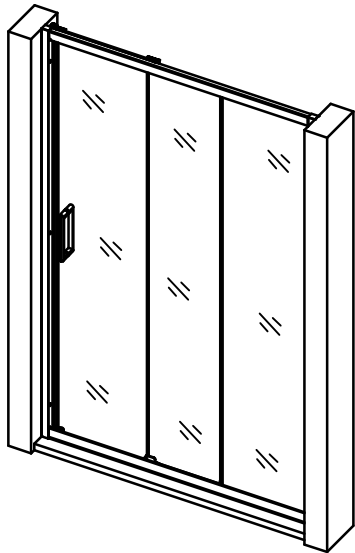

L

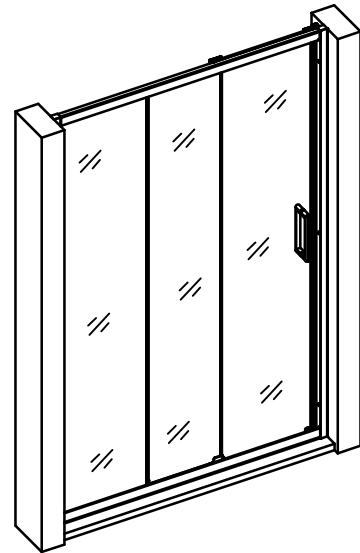

1

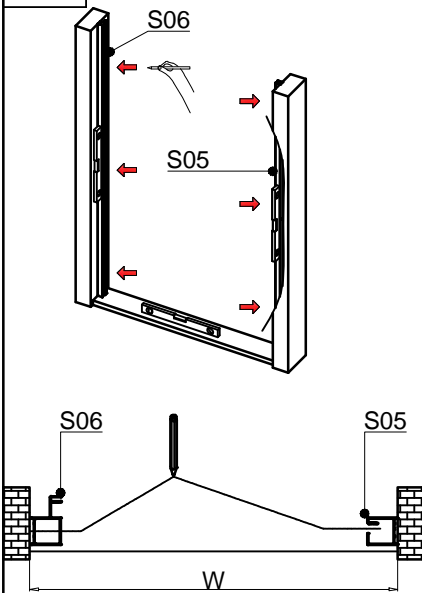

1.1

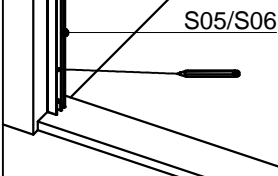

1.2

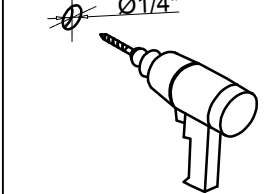

1.3

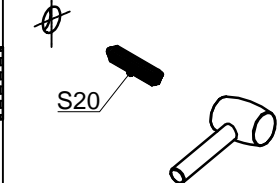

2

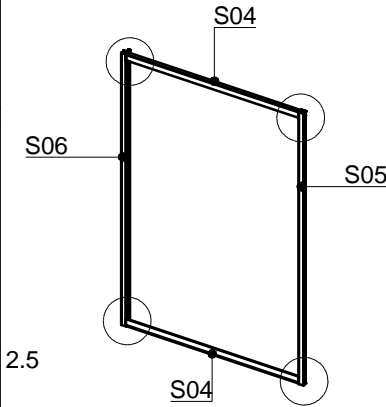

2.1

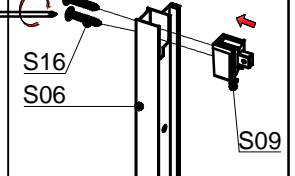

2.2

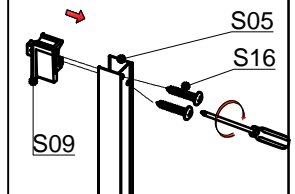

2.3

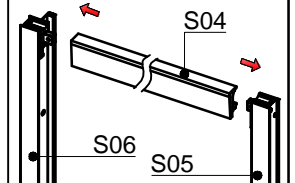

3

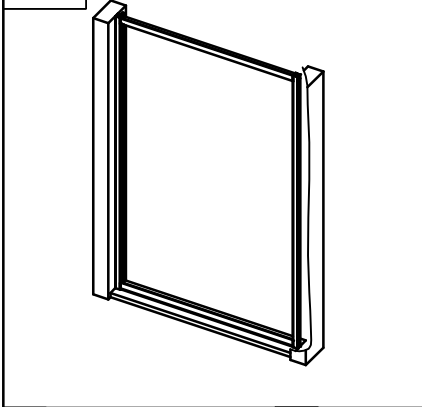

3.1

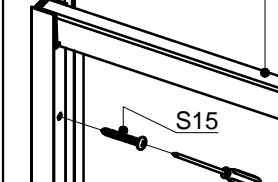

3.2

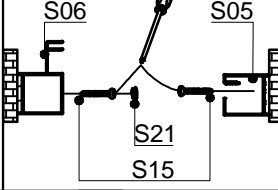

4

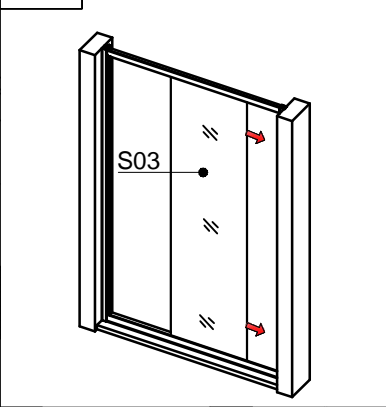

4.1

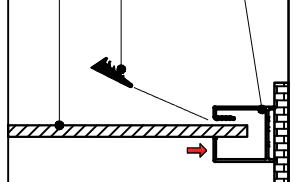

4.2

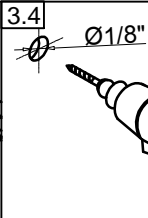
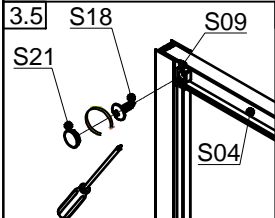
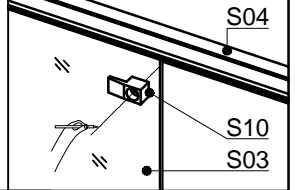

3.3

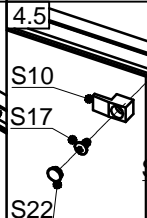
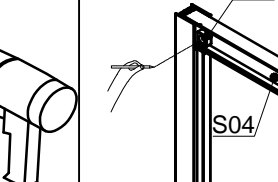

4.4

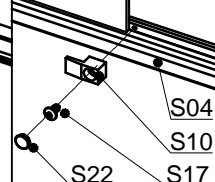

4.3

