

AFSL-C SERIES

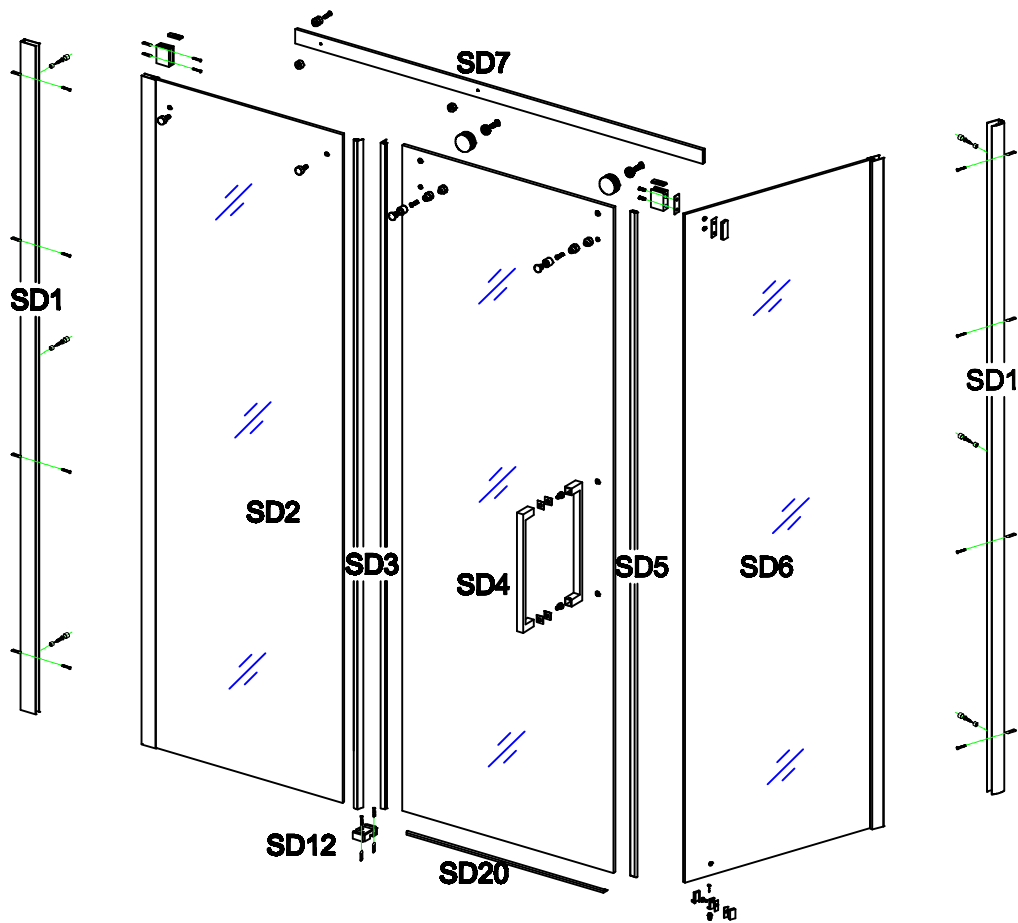

<p>SD10</p> <p>30 ST4</p> <p>8X</p>	<p>SD11</p> <p>10 ST4</p> <p>6X</p>	<p>SD12</p> <p>20 ST4</p> <p>3X</p>	<p>SD13</p> <p>11X</p>	<p>SD14</p> <p>6X</p>
<p>SD15</p> <p>2X</p>	<p>SD16</p> <p>2X</p>	<p>SD17</p> <p>2X</p>	<p>SD18</p> <p>2X</p>	<p>SD19</p> <p>2X</p>
<p>SD20</p> <p>1X</p>	<p>SD21</p> <p>1X</p>	<p>SD22</p> <p>1X</p>	<p>SD23</p> <p>1X</p>	

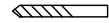
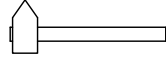
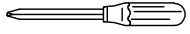
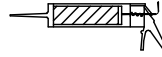
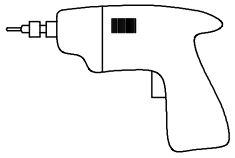

Ø6

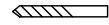

Ø3.2

L

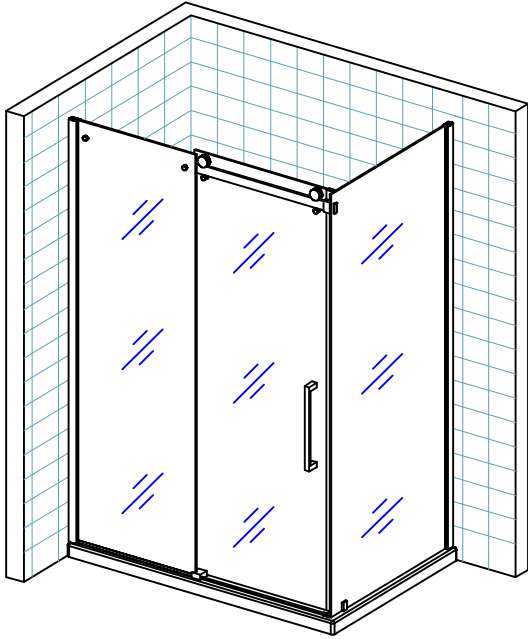

R

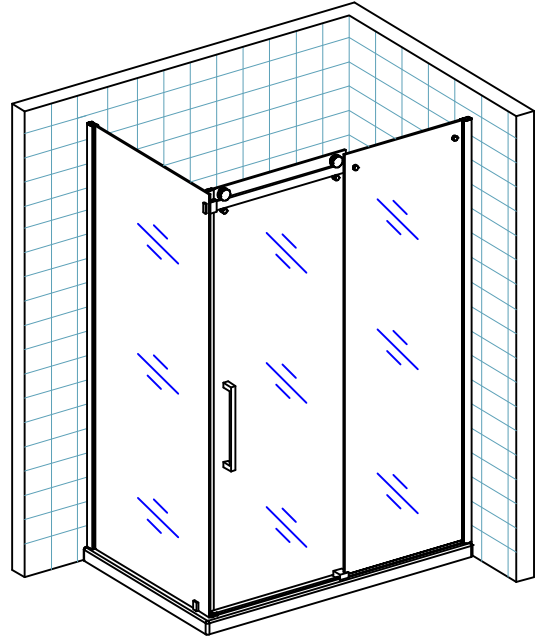

1

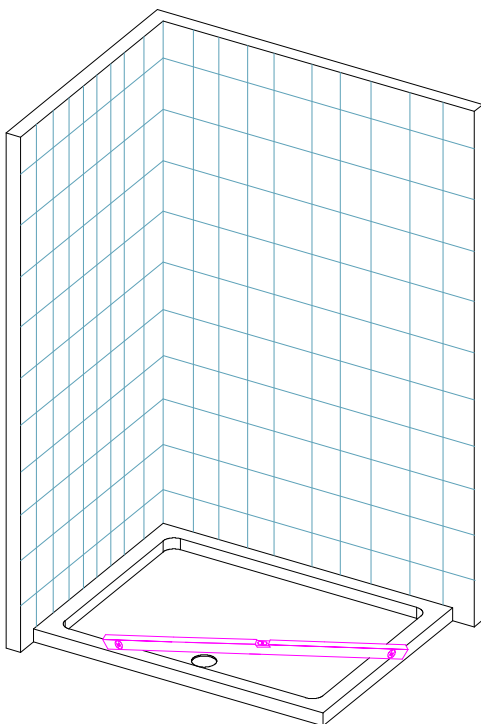

2

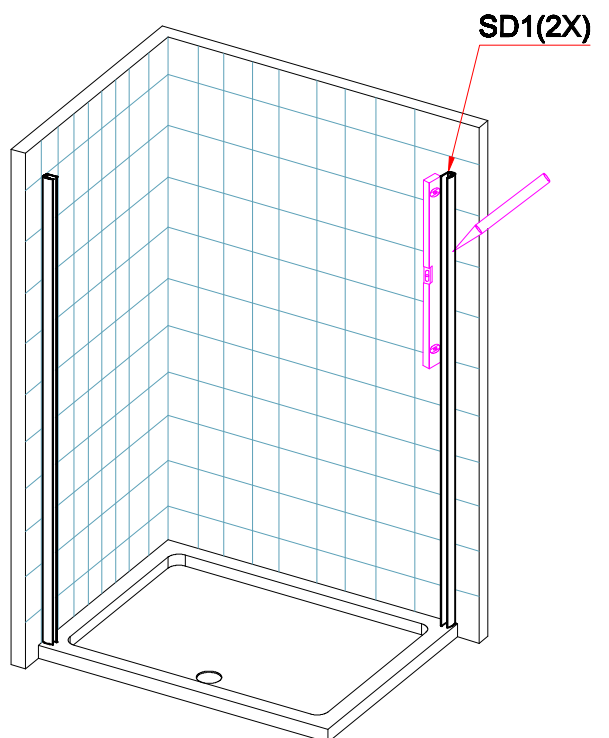

3

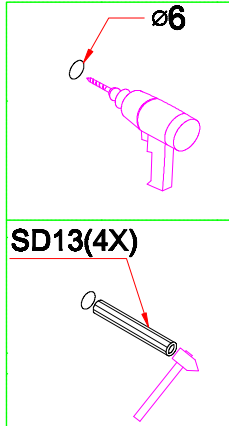
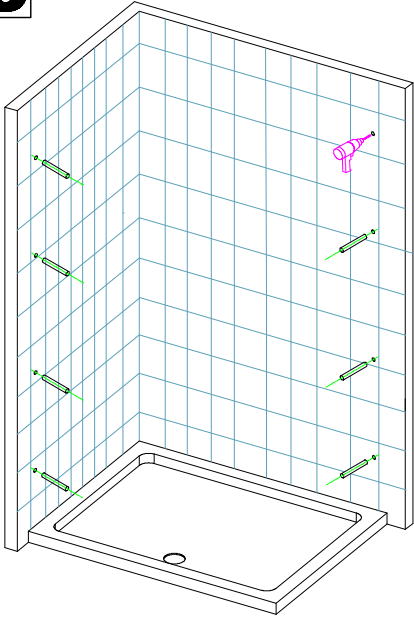

4

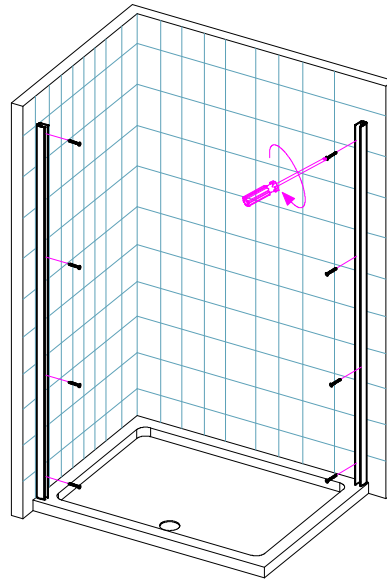

5

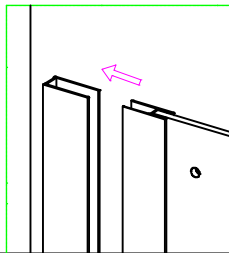
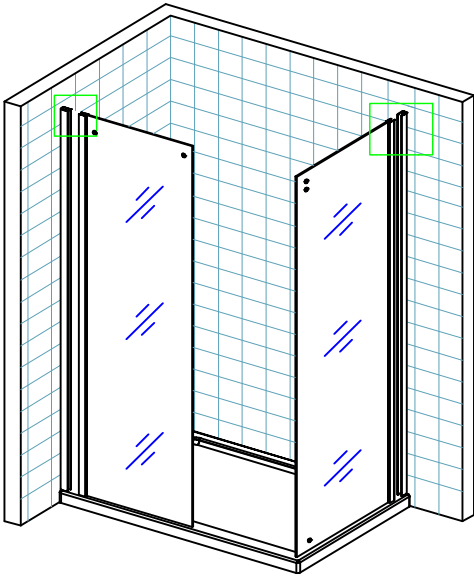

6

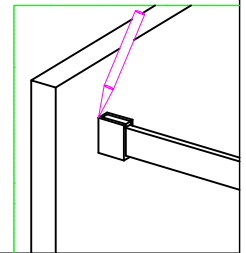
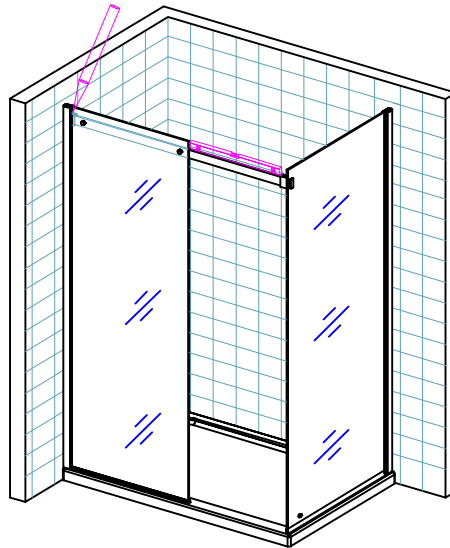

7

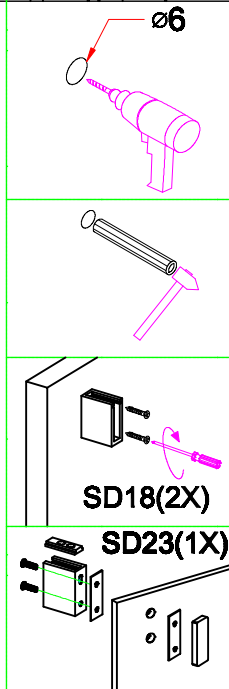
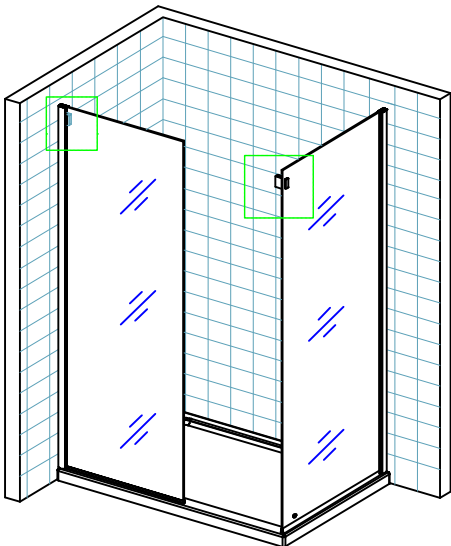

8

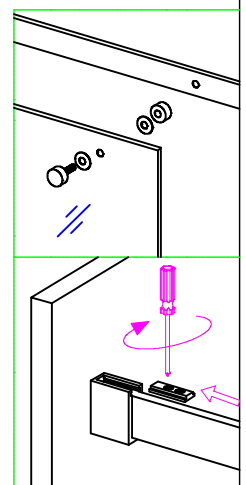
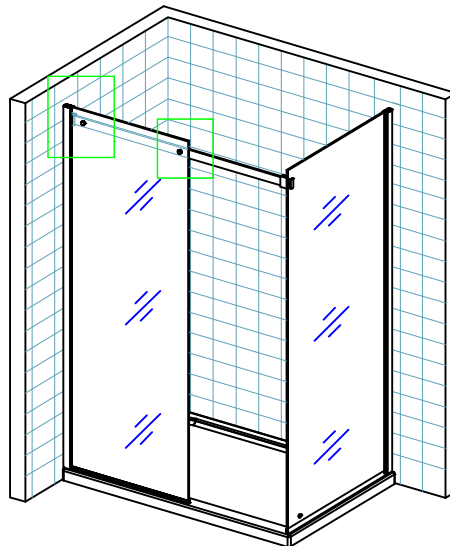

9

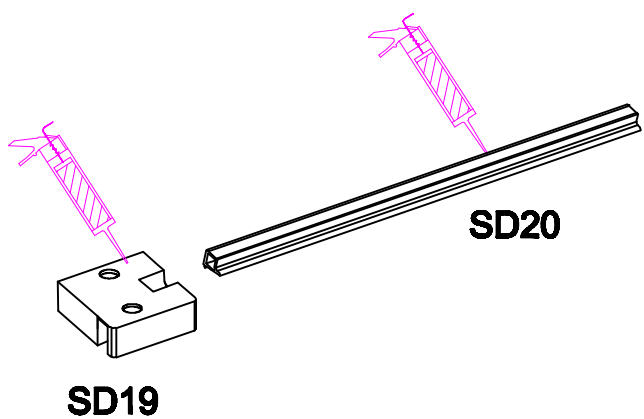

10

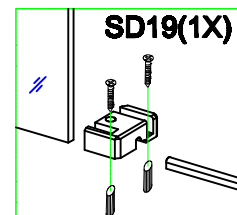
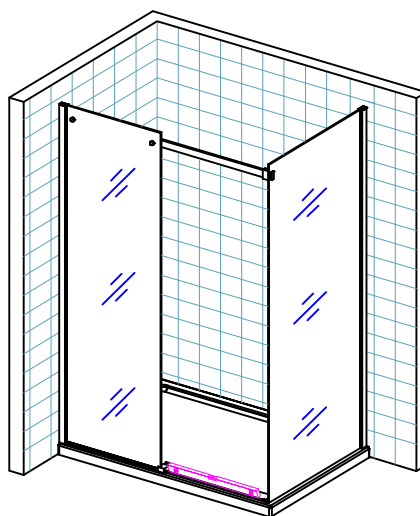

11

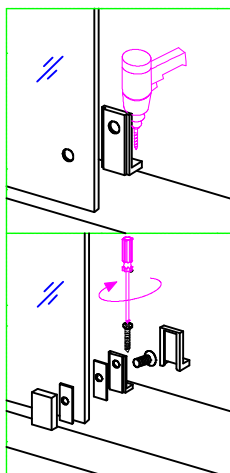
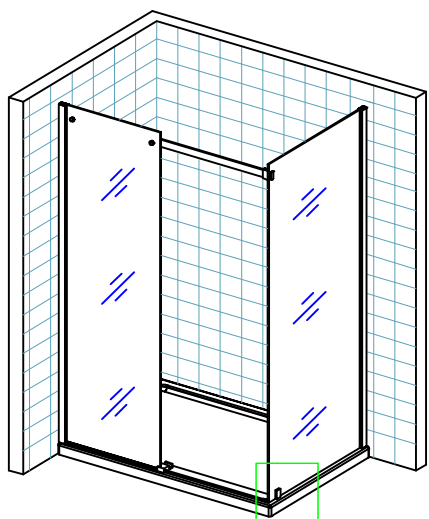

12

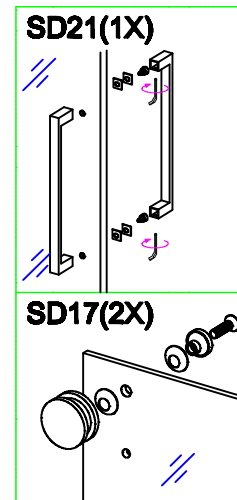
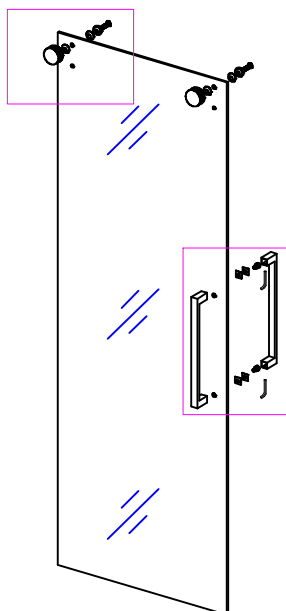

13

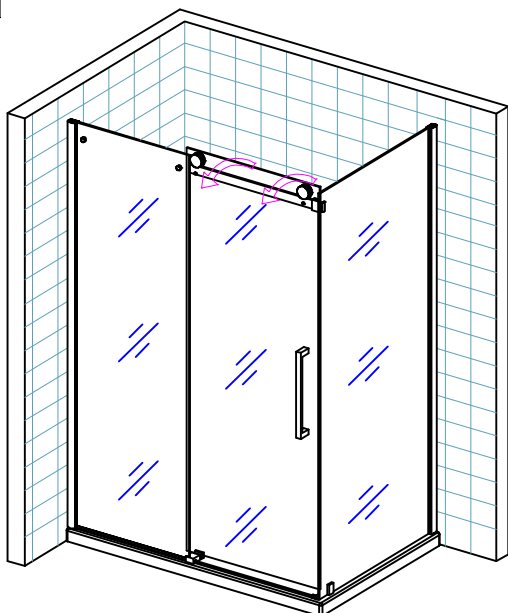

14

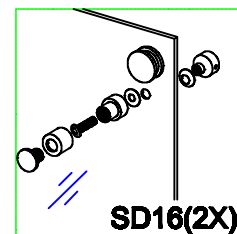
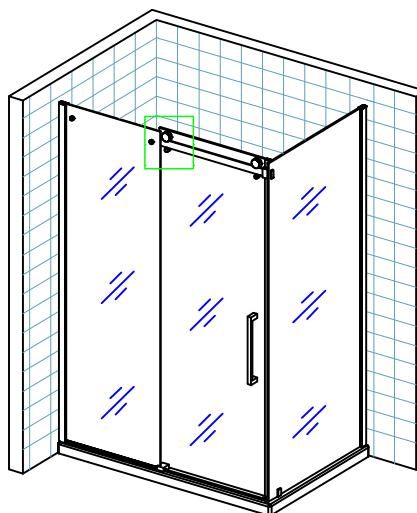

15

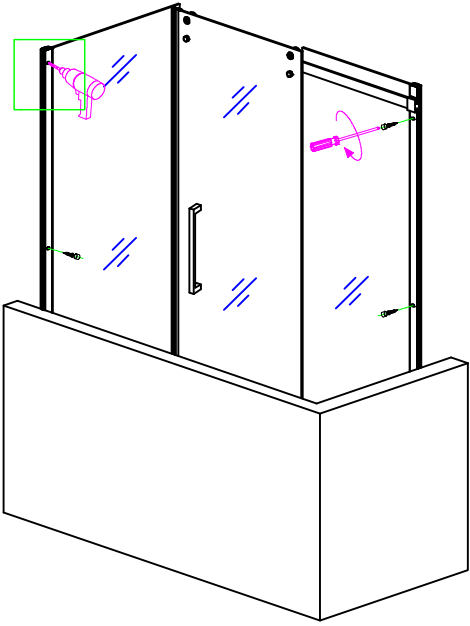

16

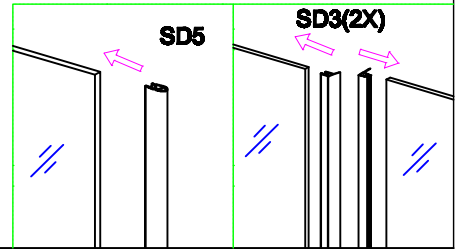
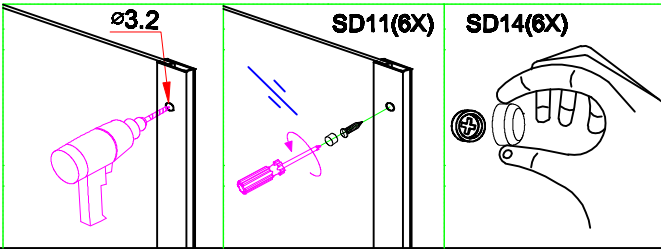
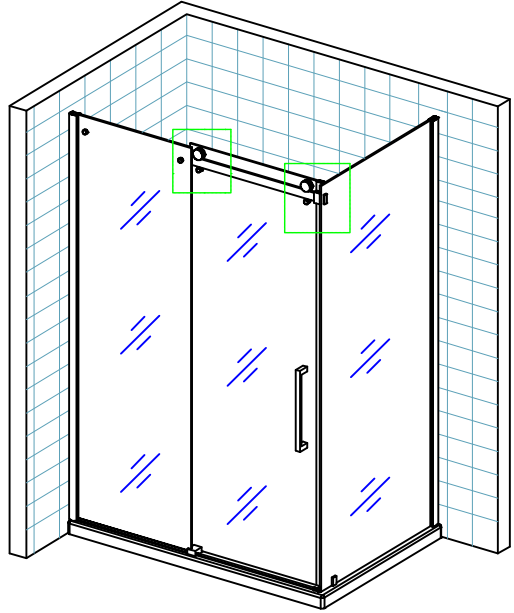

17

