

**1** Attach GPS Mount and remove the protective film from mount and camera lens

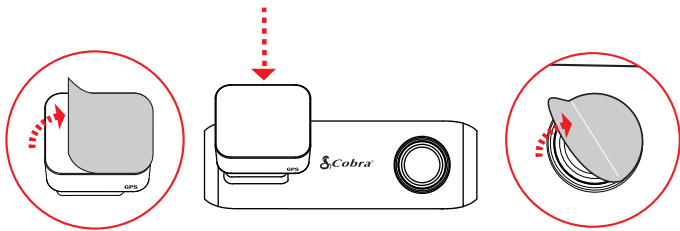

**2** Attach Camera Assembly to Windshield

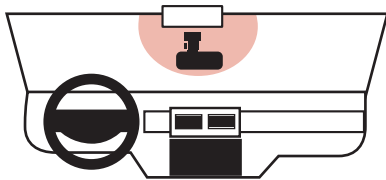

**3** Connect to GPS Mount

To 12V Power Source

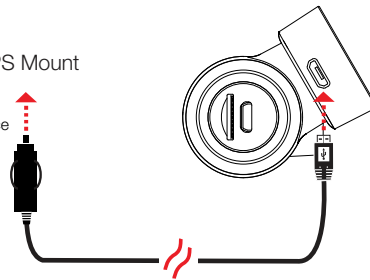

**4** Camera automatically turns on and begins recording

Blue LED indicator lights when camera is powered up

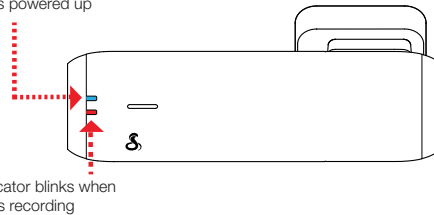

**5** View the camera's videos and adjust settings using the Drive Smarter App

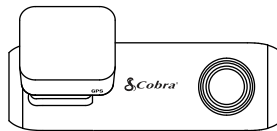

- Adjust Volume
- Change Language
- Change Resolution
- Format SD Card
- Update Firmware
- ...and more!

**Cobra**<sup>®</sup>

**SC 100**  
DASH CAM



**QUICK START GUIDE**

Scan QR Code For  
Additional Languages:



# THANK YOU!

## For purchasing the new COBRA® SC 100

View, edit and share from your smartphone or desktop.  
Share & receive real-time driver alerts.  
Download today!  
drivesmarter.com/downloads



Full manual available at: [www.cobra.com](http://www.cobra.com)



FCC ID: BB0SC100, IC: 906A-SC100. THIS DEVICE COMPLIES WITH PART 15 OF THE FCC RULES. OPERATION IS SUBJECT TO THE FOLLOWING TWO CONDITIONS: (1) THIS DEVICE MAY NOT CAUSE HARMFUL INTERFERENCE, AND (2) THIS DEVICE MUST ACCEPT ANY INTERFERENCE RECEIVED INCLUDING INTERFERENCE THAT MAY CAUSE UNDESIRABLE OPERATION.

FCC NOTE: Modifications not expressly approved by the manufacturer could void the user's FCC granted authority to operate the equipment.

Cobra® and the snake design are registered trademarks of Cobra Electronics Corporation, USA. Cobra Electronics Corporation™ is a trademark of Cobra Electronics Corporation, USA. Other trademarks and trade names are those of their respective owners.

## SC 100 Features

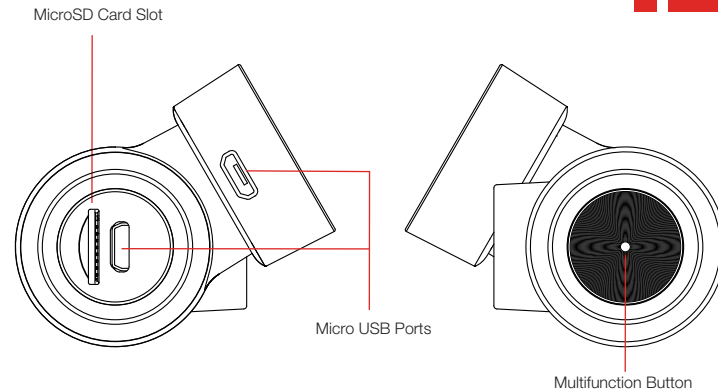
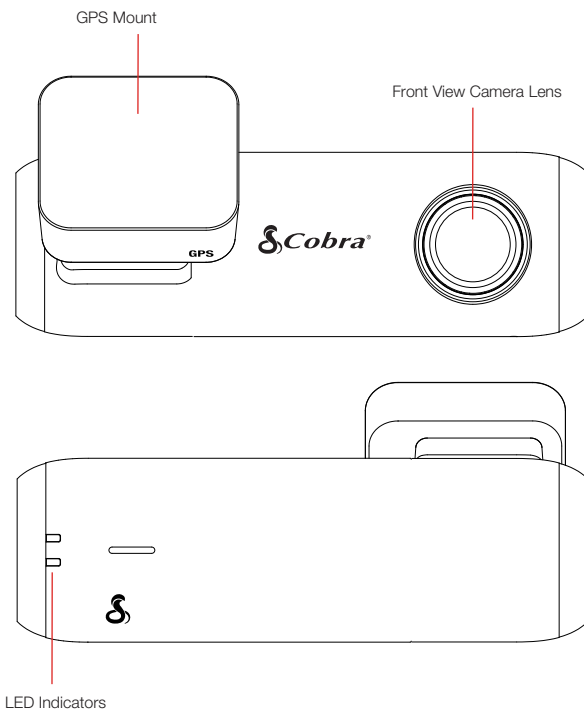

Button Press	Camera Action
Press and Hold 3 seconds	Power on/off
Short Press (Not Recording)	Begin Recording
Short Press (During Recording)	Lock Video
2x Short Press	Take Photo
Press and Hold 10 seconds	Reset

