

HOLDUP CORNER BOX

Instruction Sheet

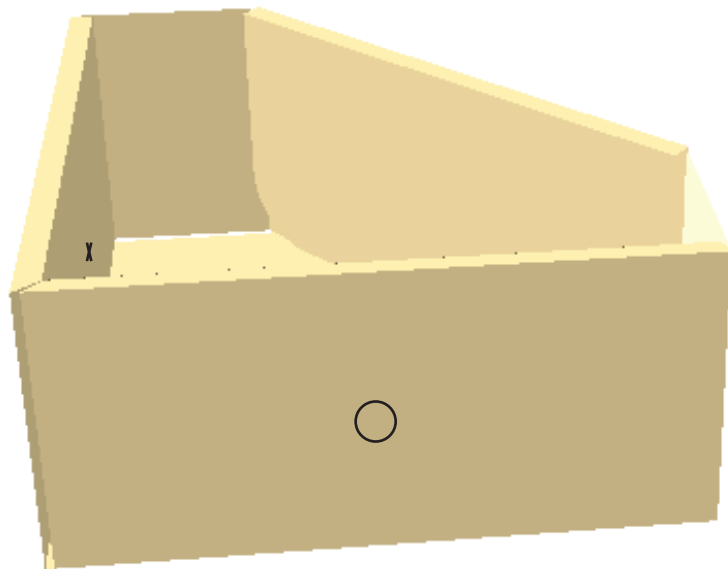

CONTENT

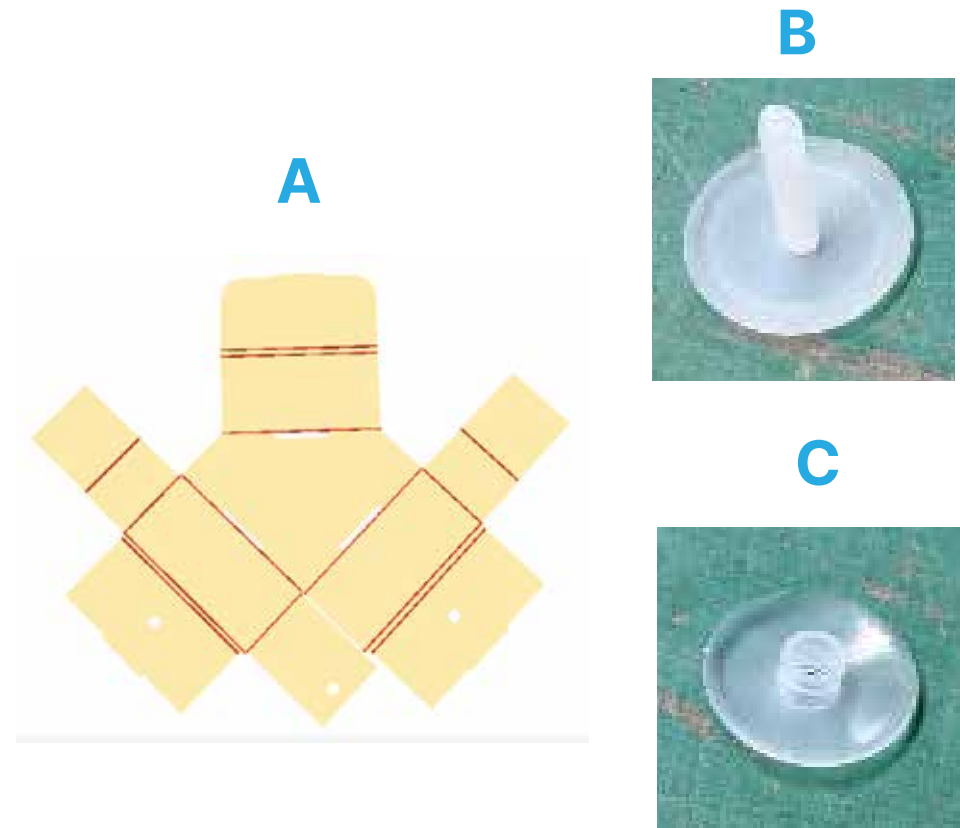

1

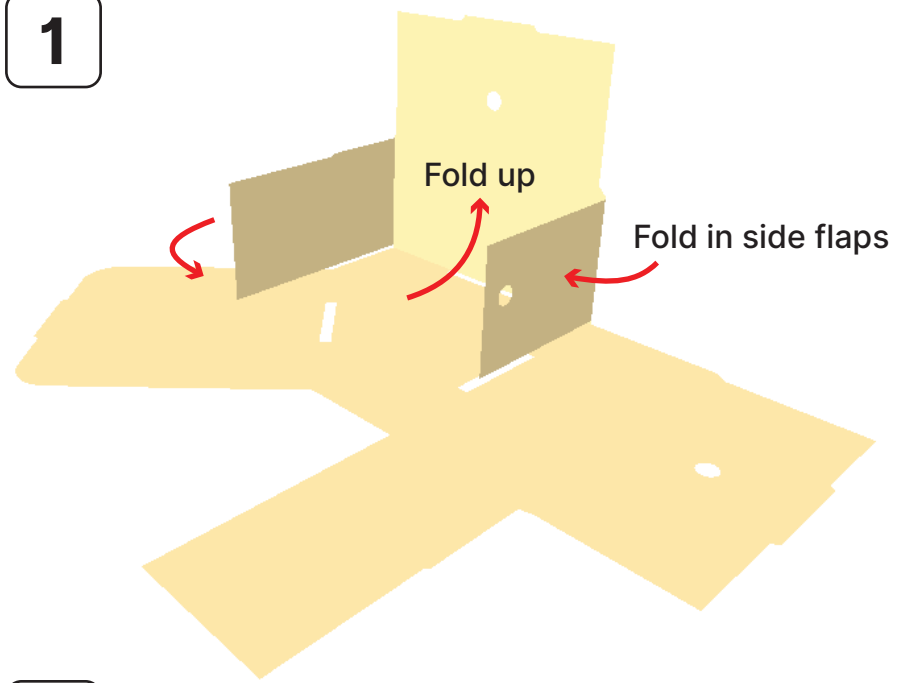

2

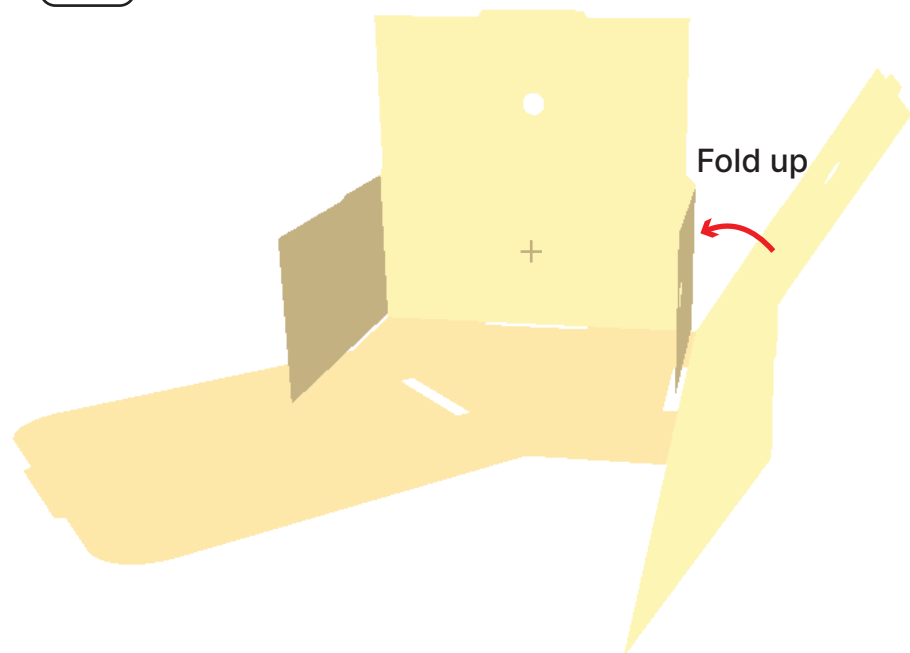

3

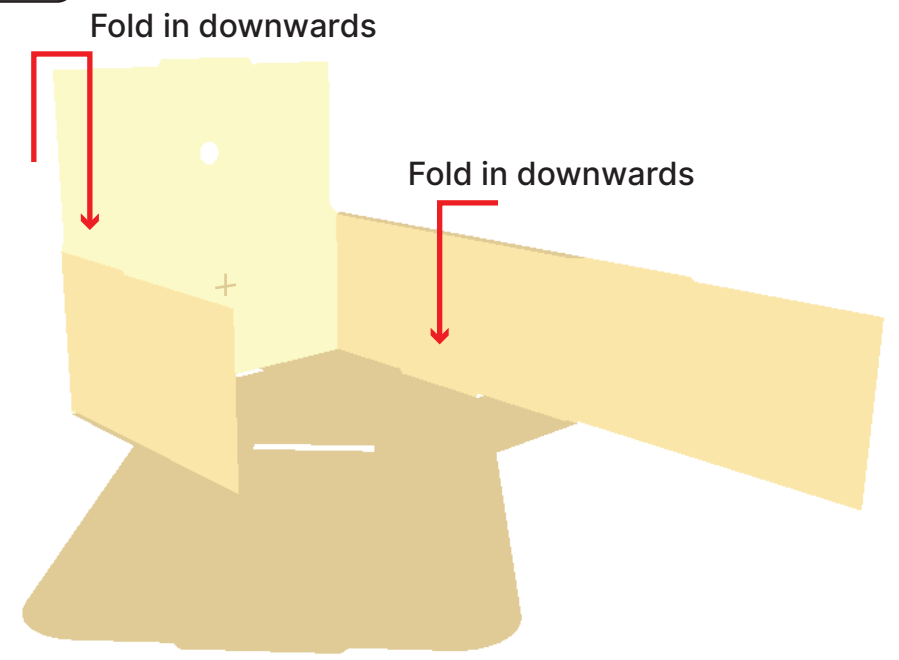

4

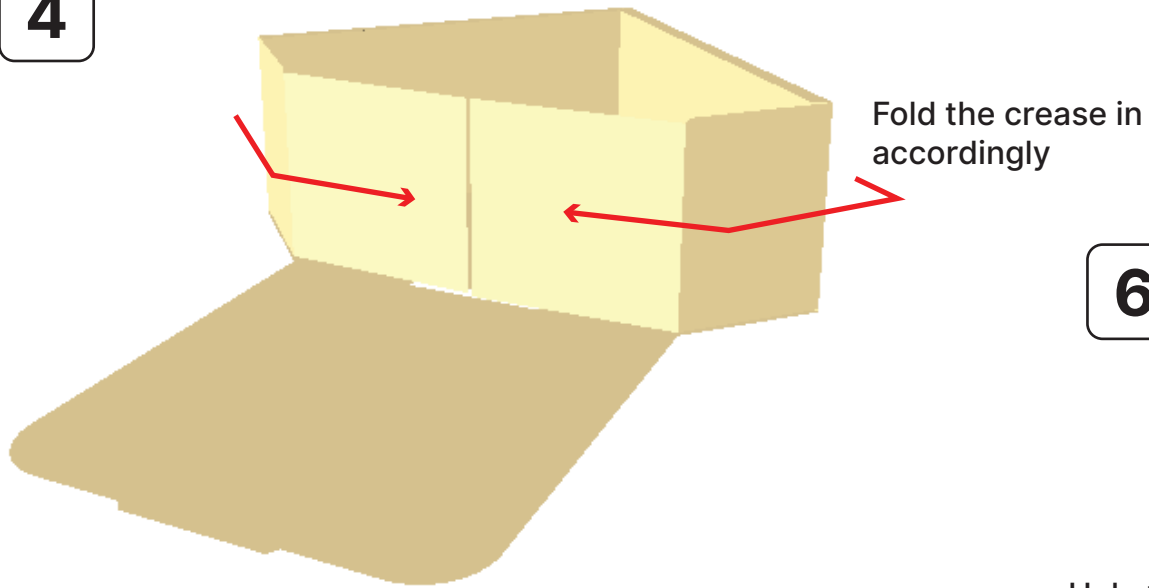

6

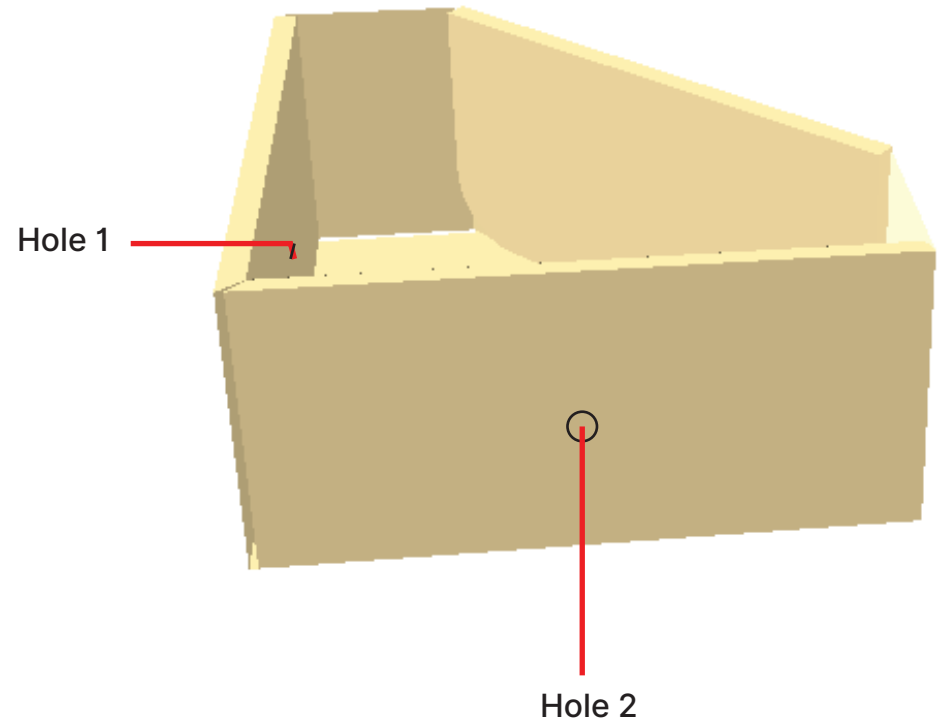

5

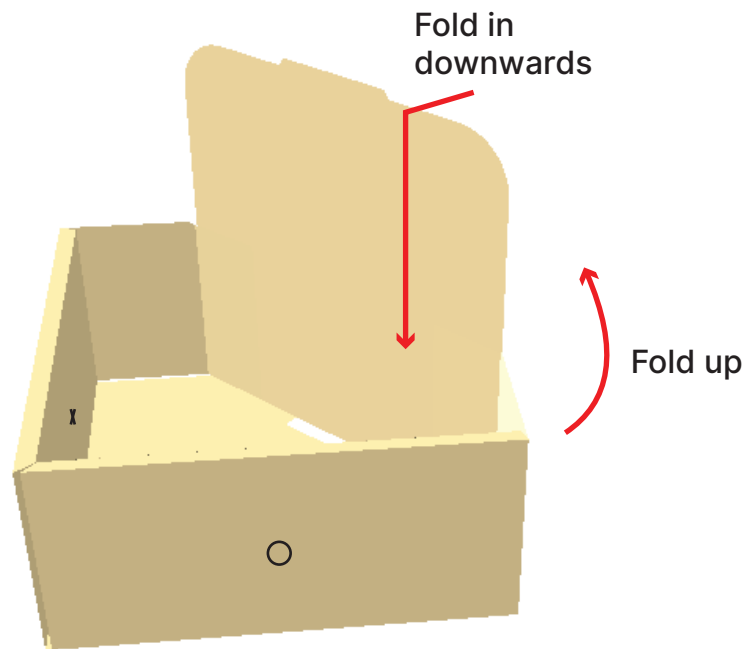

HOW TO CONNECT THE HOLDER TO YOUR DIVIDER

B



C



1

This is the template given.



2

Place template at your desired position & mark the position of the hole.



3

Use a screwdriver to create a hole through the marked position.



4

Place Part B into the hole of the holder.

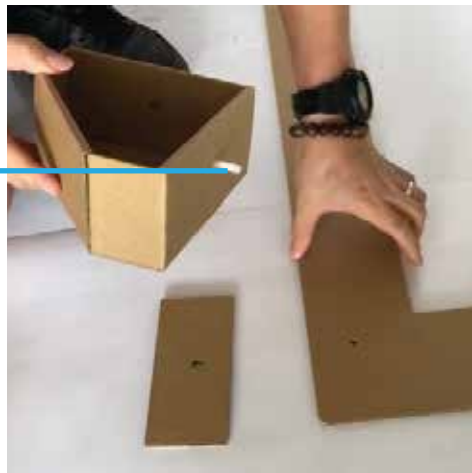

5

Push Part B through the divider's hole.

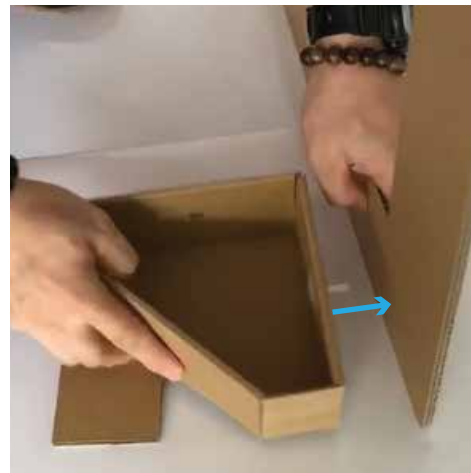

6

Last but not least, secure everything in place with Part C.

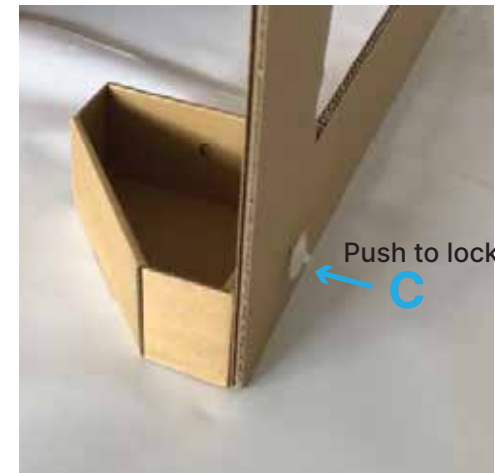

B