

SARAH ELLISON.

ZEPHYR 3.5 SEATER SOFA ASSEMBLY INSTRUCTIONS

Thank you for purchasing the Sarah Ellison Zephyr 3.5 seater sofa. This document lists the contents included in your delivery. Please take the time to identify the hardware, as well as the individual components of this product. As you unpack and prepare for assembly, place the contents on a carpeted or padded area to protect them from damage.

HARDWARE

5 Legs

TOOLS REQUIRED

None

PEOPLE REQUIRED FOR ASSEMBLY

A minimum of two people are required to assemble this product

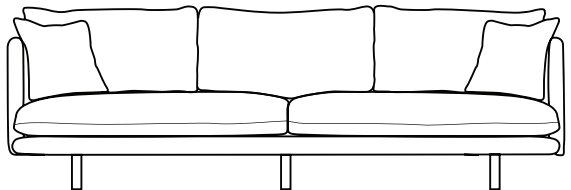

ESTIMATED TIME OF ASSEMBLY

15 minutes

CUSTOMER SERVICE

For Australian customer service contact : info@sarahellison.com.au

For any international customer service inquires please contact the retailer of purchase.

SARAH ELLISON.

STEP 1

Open box carefully, ensuring the blade of the knife does not come into contact with the product.

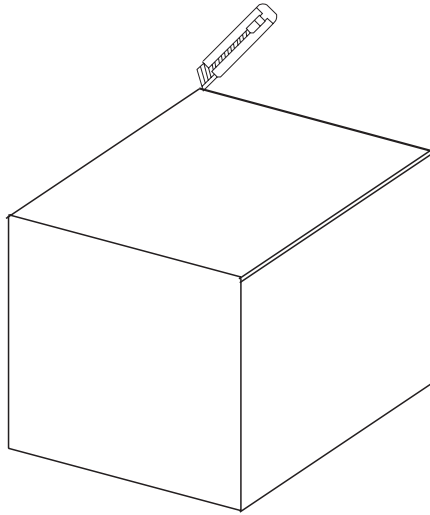

STEP 2

Remove packaging and lift the product up out of box and gently place on ground.

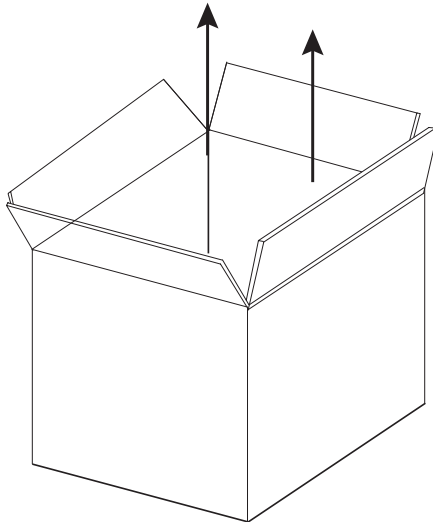

SARAH ELLISON.

STEP 3

Screw each leg clockwise into the base until tight.

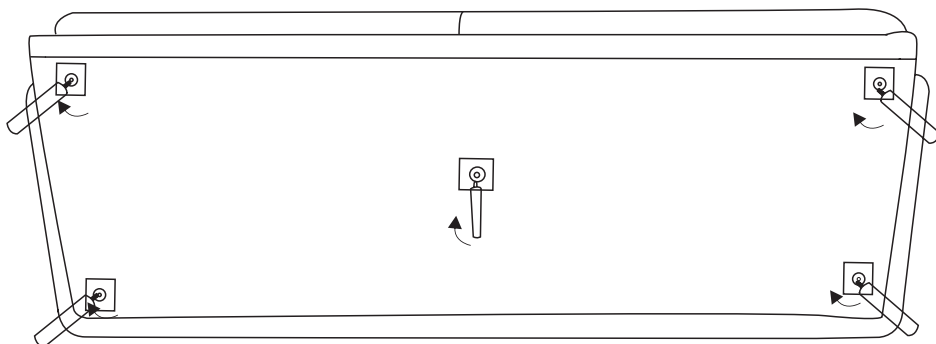

STEP 4

Position your sofa in your room and don't forget to recycle the packaging where possible.

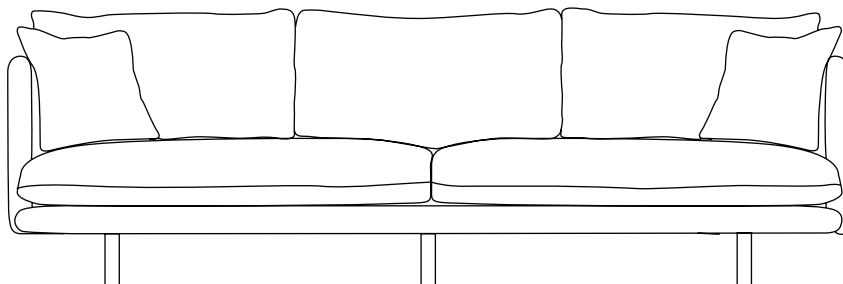

CARE INSTRUCTIONS

With a little care you can prolong the life of your furniture. The following information is only intended as a general guideline. Please follow the instructions to ensure maximum longevity of your Sarah Ellison furniture.

- Vacuum textiles regularly with an upholstery attachment to remove dust and dirt.
- Place textiles out of direct sunlight to help prevent fading. Dark colors and cotton fabrics are particularly susceptible to sun.
- Have upholstered items professionally cleaned annually. Rotate, turn and fluff cushions periodically to promote uniform wear.
- Feather and down cushions have excellent recovery, but much like down comforters or pillows, need to be fluffed frequently to restore their loft. Some feather loss is normal. Vacuuming with an upholstery attachment between the fabric casings and cushions will help prevent feathers from poking through the fabric.
- In some cases, spot cleaning can cause a ring or fading. It is best to have the entire piece or cushion casing cleaned by a professional upholstery cleaning service to ensure uniform results.
- If you decide to spot clean on your own, check the standard cleaning codes to determine the correct type of product to use.
- Blot spills immediately with a clean, dry white cloth. Always blot from the outer edges inward to reduce the chance of a stain ring. Avoid hot water, which can set a stain.

S E.