



medical  
sales &  
service

GENERAL SURGERY



**DTR Medical**<sup>®</sup>



YOUR STERILE SINGLE-USE SOLUTION  
WITHOUT COMPROMISE

# INNOVATION • QUALITY • SERVICE



## Matching reusable standards

### Save Time - Reprocessing

- First time sharpness
- Instrument damage/blockage is limited



## Suitable for high risk procedures

### Save Lives - Contamination

- Cross-infection is eliminated
- Risk is avoided



## Cost effective

### Save Money – Increase Productivity

- Theatre and clinic time IS REDUCED
- Diminished re-processing, repairs and replacement

YOUR STERILE SINGLE-USE SOLUTION

## Contents

|   |       |
|---|-------|
| <b>Forceps</b>  | 4-7   |
| <b>Clamps</b>   | 7     |
| <b>Needle Holders</b><br><i>Including Mayo-Hegar, Kilner &amp; Crilewood Needle Holders</i> | 8     |
| <b>Scissors</b><br><i>Including Metzenbaum, Stevens Tenotomy &amp; Reynolds Scissors</i>    | 8-10  |
| <b>Suture Packs</b>   | 11-14 |
| <b>Curettes</b>   | 15    |
| <b>Bipolar Forceps</b><br><i>Including Bayonet Bipolar Forceps</i>                          | 15-17 |
| <b>Micro Needle Electrodes</b>  | 18    |
| <b>Clamp Covers</b>   | 19    |
| <b>Silicone Slings</b>  | 19    |
| <b>General &amp; Vascular</b>   | 20    |
| <b>Heparin Flushing Needle</b>  | 20    |
| <b>Vascular Booties</b>   | 20    |
| <b>Tibbs Arterial Cannula</b>   | 21    |
| <b>Retractors</b>   | 22    |
| <b>Vasectomy Set, VNUS Closure &amp; Phlebectomy Hooks</b>                                  | 22-23 |
| <b>Suction Handles</b><br><i>Including Frazier, Micro, Poole &amp; Long Suction</i>         | 24-27 |
| <b>Tip Shields</b>  | 27    |
| <b>Tubing Products</b>  | 28-31 |
| <b>Others</b>   | 32    |
| <b>Scope Warmer</b>   | 32    |

# Forceps

- Effective locking ratchet and robust grip

## CRILE AND MOSQUITO FORCEPS

|           |  |          |
|-----------|--|----------|
| CFS2001-D | Crile Artery Forceps 140mm Straight, double packed       | 20 units |
| CFC2001-D | Crile Artery Forceps 140mm Curved on Flat, double packed | 20 units |
| MQT5001-S | Mosquito Forceps 125mm Straight, single packed           | 50 units |
| MQC2012   | Micro Mosquito Forceps 120mm Curved, double packed       | 20 units |
| MQC2025-D | Mosquito Forceps Curved 125mm, double packed             | 20 units |
| MQC2125-D | Mosquito Forceps Curved Toothed 1x2 125mm, double packed | 20 units |



## KOCHER ARTERY FORCEPS

|           |  |          |
|-----------|--|----------|
| KAF2014-D | Kocher Artery Forceps 140mm, double packed | 20 units |
|-----------|--|----------|



**NEW**

- Effective at clamping off bleeding from blood vessels

## KOCHER-OCHSNER FORCEPS

|         |  |          |
|---------|--|----------|
| KOF2181 | Kocher-Ochsner 1x2 Toothed Forceps Straight 185mm, double packed | 20 units |
|---------|--|----------|



## SPENCER WELLS FORCEPS

|         |  |          |
|---------|--|----------|
| SWF2010 | Spencer Wells Artery Forceps 120mm Straight, double packed | 20 units |
| SWF2015 | Spencer Wells Artery Forceps 150mm Straight, double packed | 20 units |
| SWF2018 | Spencer Wells Artery Forceps 180mm Straight, double packed | 20 units |
| SWF2020 | Spencer Wells Artery Forceps 200mm Straight, double packed | 20 units |

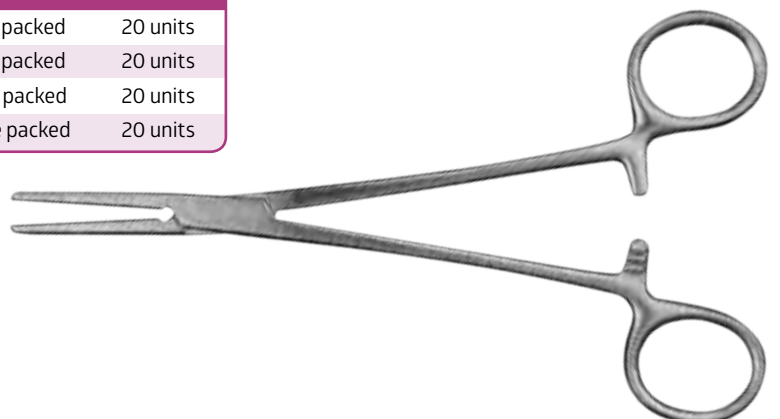

## STRASSBURG FORCEPS

SFT2015-D Strassburg Forceps Toothed 1x2 150mm, double packed 20 units

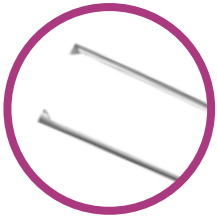

## NEW RANGE

### ADSON AND McINDOE FORCEPS

|           |  |          |
|-----------|--|----------|
| ADS5001-S | Adson Non-Toothed Forceps 120mm, single packed                       | 50 units |
| ATS5001-S | Adson Toothed Forceps 120mm, single packed                           | 50 units |
| ATP2012-D | Adson Forceps 1x2 with plateau 120mm, double packed                  | 20 units |
| ATP2015-D | Adson Forceps 1x2 with plateau 150mm, double packed                  | 20 units |
| ATS2012F  | Fine Tip Adson Toothed Forceps 1x2 with plateau 120mm, double packed | 50 units |
| MDF5001-S | McIndoe Dissecting Forceps 150mm, Non-Toothed, single packed         | 50 units |



Adson Toothed

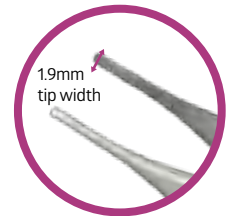

Adson Non-Toothed



We also do Adson Bipolar Forceps see p15

Adson Toothed Forceps 120mm



Adson Forceps 150mm with plateau



Adson Forceps 120mm with plateau



Fine Tip Adson Toothed Forceps

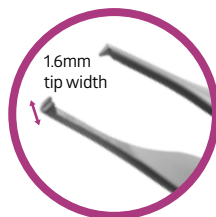

Adson Forceps

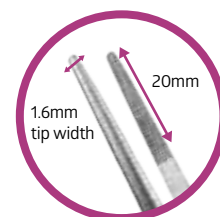

McIndoe Forceps 150mm



# Forceps



TIME

## FINE SUTURE FORCEPS

|           |   |          |
|-----------|---|----------|
| SPF2001-S | Fine Suture Forceps Plain 105mm, single packed    | 20 units |
| SSF2001-S | Fine Suture Forceps Serrated 105mm, single packed | 20 units |
| SPF2001-D | Fine Suture Forceps Plain 105mm, double packed    | 20 units |
| SSF2001-D | Fine Suture Forceps Serrated 105mm, double packed | 20 units |

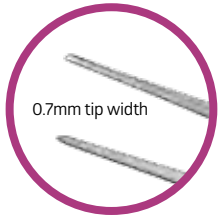

0.7mm tip width

Plain

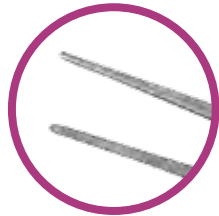

Serrated



Looking for a Fine Suture Pack?  
see p11

## DEBAKEY FORCEPS

|           |  |          |
|-----------|--|----------|
| DAF2016-D | DeBakey Atraumatic Dissecting Forceps 160mm, double packed | 20 units |
|-----------|--|----------|

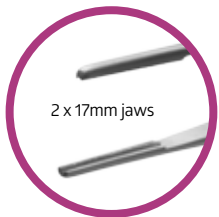

2 x 17mm jaws

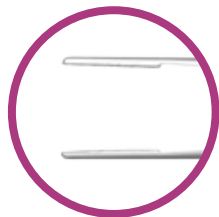

## GILLIES FORCEPS

|           |   |          |
|-----------|---|----------|
| GDF2001-S | Gillies Toothed Dissecting Forceps 160mm, single packed | 20 units |
|-----------|---|----------|

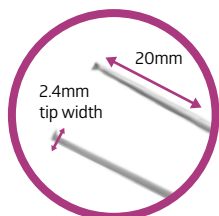

2.4mm  
tip width

20mm



### ALLIS TISSUE FORCEPS

ATF2341 Allis Tissue Forceps 3:4 teeth, 160mm, double packed 20 units

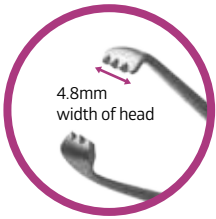

### RAMPLEY SPONGE HOLDER

RSH2181 Rampley Sponge Holders 180mm, double packed 20 units

RSH2241 Rampley Sponge Holders 240mm, double packed 20 units

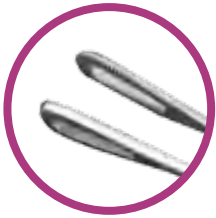

## Clamps

### CLAMPS

BTC2013-D Backhaus Towel Clamp 135mm, double packed 20 units

TCF2051 Tubing Clamps 150mm, double packed 20 units

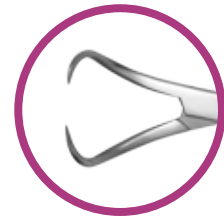
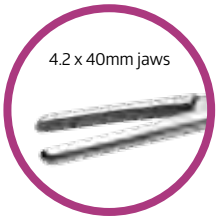

**i** You may also be interested in Silicone Tubing see p28-31

# Needle Holders

## NEEDLE HOLDERS

|            |   |          |
|------------|---|----------|
| MNH2013    | Mayo-Hegar Needle Holder 130mm, double packed             | 20 units |
| MNH2015    | Mayo-Hegar Needle Holder 150mm, double packed             | 20 units |
| MNHG2013-D | Mayo-Hegar Needle Holder with groove 130mm, double packed | 20 units |
| KNH2013    | Kilner Needle Holder 135mm, double packed                 | 20 units |
| CNH2015    | Crilewood Needle Holder 150mm, double packed              | 20 units |
| DNH2018-D  | DeBakey Needle Holder 180mm, double packed                | 20 units |
| HNH2013    | Halsey Needle Holder 130mm, double packed                 | 20 units |
| RNH2015-D  | Ryder Needle Holder 150mm, double packed                  | 20 units |



Mayo with groove, 130 mm



Mayo, 150 mm



Crilewood



Ryder

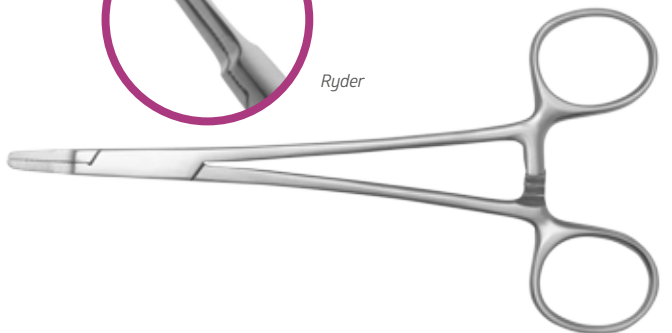

Halsey

# Scissors

£  
COST

- Stainless steel sharp/sharp scissors
- First time sharpness which cut even at the tips

## KILNER SCISSORS

KSS2001-S Kilner Scissors 116mm, single packed 20 units

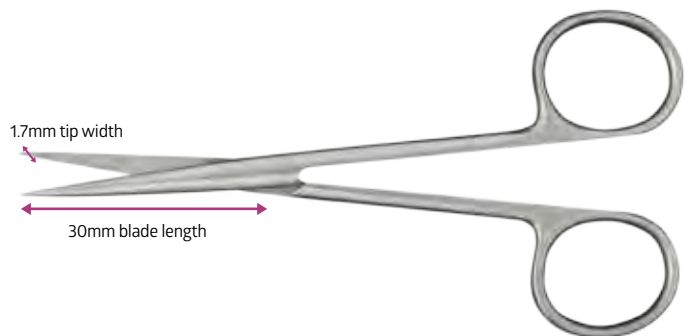

1.7mm tip width

30mm blade length



## IRIS SCISSORS

|           |   |          |
|-----------|---|----------|
| ISS2111-S | Iris Scissors Straight 90mm, single packed  | 20 units |
| ISC2111-S | Iris Scissors Curved 90mm, single packed    | 20 units |
| ISS2110-D | Iris Scissors Straight 110mm, double packed | 20 units |
| ISC2110-D | Iris Scissors Curved 110mm, double packed   | 20 units |

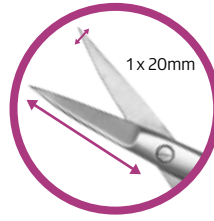

Straight

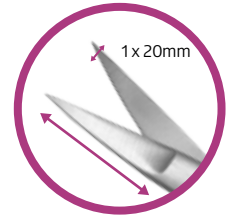

Curved



Curved  
90mm



Iris Scissors Straight 90mm

## STEVENS TENOTOMY SCISSORS

|           |   |          |
|-----------|---|----------|
| TSS2001-S | Stevens Tenotomy Scissors 115mm Straight, single packed | 20 units |
| TSC2001-S | Stevens Tenotomy Scissors 115mm Curved, single packed   | 20 units |
| TSS2001-D | Stevens Tenotomy Scissors 115mm Straight, double packed | 20 units |
| TSC2001-D | Stevens Tenotomy Scissors 115mm Curved, double packed   | 20 units |

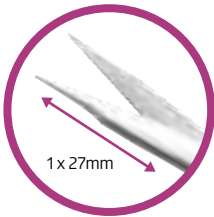

Straight

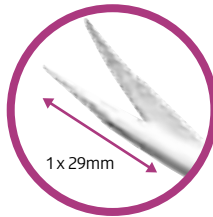

Curved

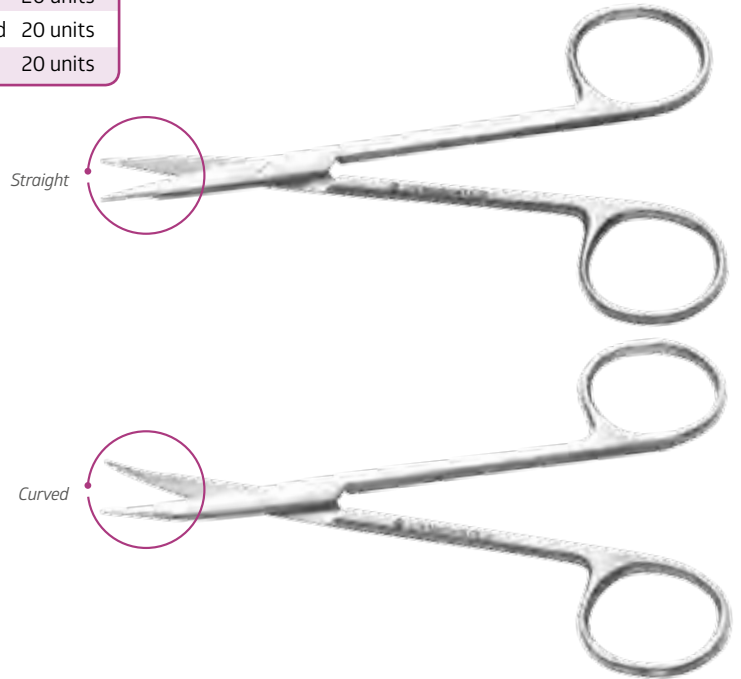

Straight

Curved



We also do Stevens Maxillo Suture packs see table p14



COST

- Both straight options have 0.4mm tip width
- Curved option offers greater flexibility for delicate procedures

## VANNAS SCISSORS

|         |   |          |
|---------|---|----------|
| VSS2081 | Vannas Scissors Straight 85mm, double packed  | 20 units |
| VSS2121 | Vannas Scissors Straight 125mm, double packed | 20 units |
| VSC2081 | Vannas Scissors Curved 85mm, double packed    | 20 units |

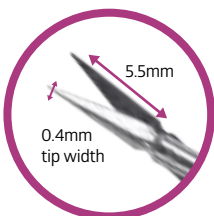

VSS2081

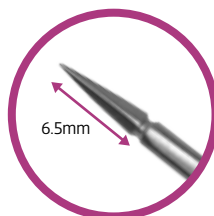

VSS2121

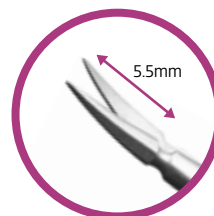

VSC2081



# Scissors

## MAYO SCISSORS

|         |  |          |
|---------|--|----------|
| MSS2141 | Mayo Scissors Straight Bevelled Blade 140mm, double packed | 20 units |
| MSC2141 | Mayo Scissors Curved Bevelled Blade 140mm, double packed   | 20 units |
| MSS2171 | Mayo Scissors Straight Bevelled Blade 170mm, double packed | 20 units |
| MSC2171 | Mayo Scissors Curved Bevelled Blade 170mm, double packed   | 20 units |



*Straight*

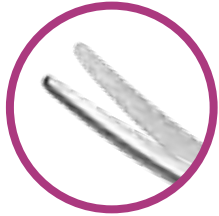

*Curved*



## REYNOLDS SCISSORS

|           |   |          |
|-----------|---|----------|
| RSC2014-D | Reynolds Scissors Curved 145mm, double packed | 20 units |
|-----------|---|----------|



## METZENBAUM SCISSORS

|           |  |          |
|-----------|--|----------|
| ZSC2121-D | Baby Metzenbaum Scissors Curved 120mm, double packed | 20 units |
| ZSC2141-D | Metzenbaum Scissors Curved 145mm, double packed      | 20 units |
| ZSC2161-D | Metzenbaum Scissors Curved 160mm, double packed      | 20 units |
| ZSS2181-D | Metzenbaum Scissors Straight 180mm, double packed    | 20 units |
| ZSC2181-D | Metzenbaum Scissors Curved 180mm, double packed      | 20 units |
| ZSS2201-D | Metzenbaum Scissors Straight 200mm, double packed    | 20 units |
| ZSC2201-D | Metzenbaum Scissors Curved 200mm, double packed      | 20 units |

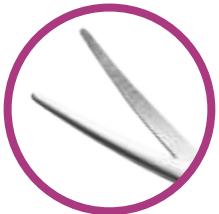

*Metzenbaum Scissors Curved 180mm*



*Metzenbaum Scissors Curved 145mm*

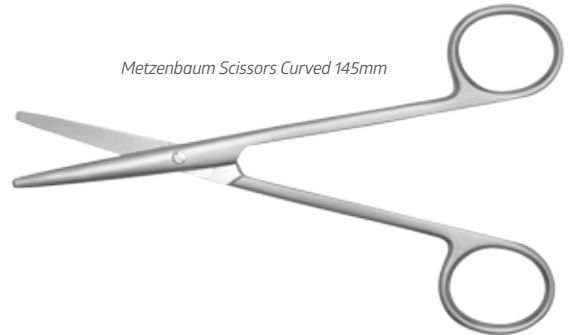







*Metzenbaum Scissors Curved 160mm*







# Suture Packs





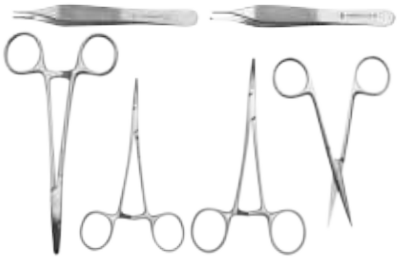

■ Customised and double packed options available

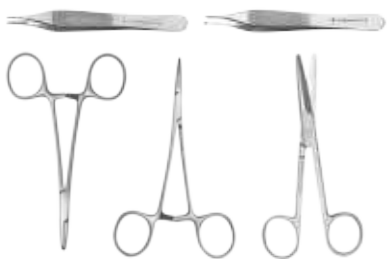
| SUTURE PACKS |   |   |   |
|--------------|---|---|---|
| FSP2002-S    |    | Fine Suture Pack<br>single packed<br>20 units | <ul style="list-style-type: none"> <li>■ Iris Scissors Straight 90mm</li> <li>■ Fine Suture Forceps Serrated 105mm</li> </ul>   |
| SPAI1004     |    | Suture Pack<br>single packed<br>10 units      | <ul style="list-style-type: none"> <li>■ Iris Scissors Curved 90mm</li> <li>■ Adson Toothed Forceps 120mm</li> <li>■ Mayo Hegar Needle Holder 150mm</li> <li>■ No3 Blade Handle</li> </ul>  |
| SPIA2002-S   |   | Suture Pack<br>single packed<br>20 units      | <ul style="list-style-type: none"> <li>■ Adson Non-Toothed Forceps 120mm</li> <li>■ Iris Scissors Curved 90mm</li> </ul>  |
| SPIA2003-S   |  | Suture Pack<br>single packed<br>20 units      | <ul style="list-style-type: none"> <li>■ Iris Scissors Straight 90mm</li> <li>■ Adson Non-Toothed Forceps 120mm</li> <li>■ Mosquito Forceps Straight 125mm</li> </ul>   |
| SPIA1004     |  | Suture Pack<br>single packed<br>10 units      | <ul style="list-style-type: none"> <li>■ Iris Scissors Straight 90mm</li> <li>■ Adson Toothed Forceps 120mm</li> <li>■ McIndoe Dissecting Forceps Non-Toothed 150mm</li> <li>■ Mayo Hegar Needle Holder 150mm</li> </ul>                |
| SPIA1005     |  | Suture Pack<br>single packed<br>10 units      | <ul style="list-style-type: none"> <li>■ Iris Scissors Straight 90mm</li> <li>■ Adson Toothed Forceps 120mm</li> <li>■ Mosquito Forceps Straight 125mm</li> <li>■ Mayo Hegar Needle Holder 130mm</li> <li>■ No3 Blade Handle</li> </ul> |





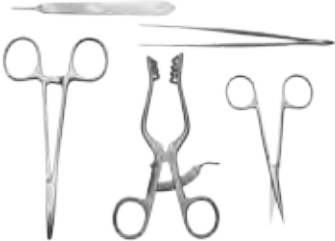

# Suture Packs

| SUTURE PACKS |   |  |   |
|--------------|---|--|---|
| SPKA2002-S   |    | Suture Pack<br>single packed<br>20 units | <ul style="list-style-type: none"> <li>■ Kilner Scissors 120mm</li> <li>■ Adson Non-Toothed Forceps 120mm</li> </ul>  |
| SPKA1004     |    | Suture Pack<br>single packed<br>10 units | <ul style="list-style-type: none"> <li>■ Kilner Scissors 120mm</li> <li>■ Adson Toothed Forceps 120mm</li> <li>■ Mayo Hegar Needle Holder 150mm</li> <li>■ No3 Blade Handle</li> </ul>  |
| SPKA1136     |   | Suture Pack<br>double packed<br>10 units | <ul style="list-style-type: none"> <li>■ Kilner Scissors 120mm</li> <li>■ Adson Toothed Forceps 120mm</li> <li>■ Adson Non-Toothed Forceps 120mm</li> <li>■ Mayo Hegar Needle Holder 130mm</li> <li>■ Mosquito Forceps Straight 125mm</li> <li>■ Micro Mosquito Forceps Curved 120mm</li> </ul> |
| SPKA1156     |  | Suture Pack<br>double packed<br>10 units | <ul style="list-style-type: none"> <li>■ Kilner Scissors 120mm</li> <li>■ Adson Toothed Forceps 120mm</li> <li>■ Adson Non-Toothed Forceps 120mm</li> <li>■ Mayo Hegar Needle Holder 150mm</li> <li>■ Mosquito Forceps Straight 125mm</li> <li>■ Micro Mosquito Forceps Curved 120mm</li> </ul> |
| SPKM2003-S   |  | Suture Pack<br>single packed<br>20 units | <ul style="list-style-type: none"> <li>■ Kilner Scissors 120mm</li> <li>■ McIndoe Dissecting Forceps Non-Toothed 150mm</li> <li>■ Mosquito Forceps Straight 125mm</li> </ul>  |
| SPMA1005     |  | Suture Pack<br>double packed<br>10 units | <ul style="list-style-type: none"> <li>■ Mayo Scissors Straight 140mm</li> <li>■ Adson Toothed Forceps 120mm</li> <li>■ Adson Non-Toothed Forceps 120mm</li> <li>■ Mayo Hegar Needle Holder 130mm</li> <li>■ Micro Mosquito Forceps Curved 120mm</li> </ul>                                     |

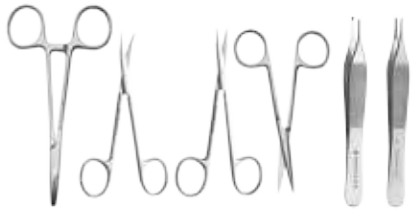
## SUTURE PACKS

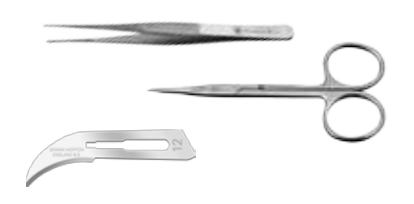
|          |   |   |  |
|----------|---|---|--|
| SPMM1005 |    | Suture Pack<br>double packed<br>10 units                                  | <ul style="list-style-type: none"> <li>■ Mayo Scissors Straight 140mm</li> <li>■ Adson Toothed Forceps 120mm</li> <li>■ Mayo Hegar Needle Holder 130mm</li> <li>■ McIndoe Dissecting Forceps Non-Toothed 150mm</li> <li>■ Micro Mosquito Forceps Curved 120mm</li> </ul> |
| STKA1004 |    | Suture Tray<br>double packed<br>10 units                                  | <ul style="list-style-type: none"> <li>■ Kilner Scissors 120mm</li> <li>■ Adson Toothed Forceps 120mm</li> <li>■ Mayo Hegar Needle Holder 150mm</li> <li>■ No3 Blade Handle</li> </ul>   |
| SPKA1005 |   | Trauma & Minor<br>Injury Suture<br>Pack<br>single packed<br>10 units      | <ul style="list-style-type: none"> <li>■ Kilner Scissors 120mm</li> <li>■ Adson Toothed Forceps 120mm</li> <li>■ Adson Non-Toothed Forceps 120mm</li> <li>■ Mosquito Forceps Straight 125mm</li> <li>■ Mayo Hegar Needle Holder 150mm</li> </ul>                         |
| SPKF1005 |  | Trauma & Minor<br>Injury Fine<br>Suture Pack<br>double packed<br>10 units | <ul style="list-style-type: none"> <li>■ Kilner Scissors 120mm</li> <li>■ Adson Toothed Forceps 120mm</li> <li>■ Mayo Hegar Needle Holder 150mm</li> <li>■ Mosquito Forceps Straight 125mm</li> <li>■ Fine Suture Forceps Serrated 105mm</li> </ul>                      |
| SPKJ1005 |  | Spinal Suture<br>Pack<br>double packed<br>10 units                        | <ul style="list-style-type: none"> <li>■ Kilner Scissors 120mm</li> <li>■ Mayo Hegar Needle Holder 130mm</li> <li>■ Adson Toothed Forceps 120mm</li> <li>■ Jefferson Retractor</li> <li>■ No3 Blade Handle</li> </ul>  |
| SPGJ1005 |  | Spinal Suture<br>Pack<br>double packed<br>10 units                        | <ul style="list-style-type: none"> <li>■ Kilner Scissors 120mm</li> <li>■ Gillies Dissecting Forceps 160mm</li> <li>■ Mayo Hegar Needle Holder 130mm</li> <li>■ Jefferson Retractor</li> <li>■ No3 Blade Handle</li> </ul>   |

# Suture Packs

| SUTURE PACKS |   |  |   |
|--------------|---|--|---|
| SPSA1006     |    | Stevens Maxillo Suture Pack<br>double packed<br>10 units | <ul style="list-style-type: none"> <li>■ Stevens Tenotomy Scissors Straight 115mm</li> <li>■ Stevens Tenotomy Scissors Curved 115mm</li> <li>■ Kilner Scissors 120mm</li> <li>■ Adson Toothed Forceps 120mm</li> <li>■ Adson Non-Toothed Forceps 120mm</li> <li>■ Mayo Hegar Needle Holder 130mm</li> </ul>                             |
| SPSA1007     |    | Stevens Maxillo Suture Pack<br>double packed<br>10 units | <ul style="list-style-type: none"> <li>■ Stevens Tenotomy Scissors Straight 115mm</li> <li>■ Stevens Tenotomy Scissors Curved 115mm</li> <li>■ Kilner Scissors 120mm</li> <li>■ Adson Toothed Forceps 120mm</li> <li>■ Adson Non-Toothed Forceps 120mm</li> <li>■ Mayo Hegar Needle Holder 130mm</li> <li>■ No3 Blade Handle</li> </ul> |
| FSP2003-S    |   | Fine Suture Pack<br>single packed<br>20 units            | <ul style="list-style-type: none"> <li>■ Iris Scissors Straight 90mm</li> <li>■ Fine Suture Forceps Serrated Straight 105mm</li> <li>■ Guarded Disposable Scalpel No12 Blade</li> </ul>   |
| SBIG1004     |  | Skin Biopsy Pack<br>double packed<br>10 units            | <ul style="list-style-type: none"> <li>■ Iris Scissors Straight 90mm</li> <li>■ Gillies Toothed Forceps 160mm</li> <li>■ Kilner Needle Holder 135mm</li> <li>■ No3 Blade Handle.</li> </ul>   |
| SBIG1005     |  | Skin Biopsy Pack<br>double packed<br>10 units            | <ul style="list-style-type: none"> <li>■ Iris Scissors Straight 90mm</li> <li>■ Gillies Toothed Forceps 160mm</li> <li>■ Kilner Needle Holder 135mm</li> <li>■ No3 Blade Handle</li> <li>■ Gillies Skin Hook Sharp</li> </ul>   |
| SBIG1007     |  | Skin Biopsy Pack<br>double packed<br>10 units            | <ul style="list-style-type: none"> <li>■ Iris Scissors Straight 110mm</li> <li>■ No3 Blade Handle</li> <li>■ Baby Metzenbaum Scissors 120mm</li> <li>■ Adson Dissecting Forceps Toothed 120mm</li> <li>■ Mosquito Forceps Straight 125mm</li> <li>■ Halsey Needle Holder 130mm</li> <li>■ Gillies Skin Hook Sharp 175mm</li> </ul>      |

# Curettes

## NEW LINES FOR 2016

- Precise and sharp scoop for effective curettage

### BECKMANN ADENOID CURETTE

|         |   |          |
|---------|---|----------|
| BAC2010 | Beckmann Adenoid Curette, 10mm Curette Edge, 220mm, double packed | 20 units |
| BAC2013 | Beckmann Adenoid Curette, 13mm Curette Edge, 220mm, double packed | 20 units |
| BAC2015 | Beckmann Adenoid Curette, 15mm Curette Edge, 220mm, double packed | 20 units |
| BAC2017 | Beckmann Adenoid Curette, 17mm Curette Edge, 220mm, double packed | 20 units |



# Bipolar Forceps



COST

- Fine stainless steel tips with a range of sizes from 0.5mm - 2mm
- Adjustable and universal 4mm plug that is tested to comply with the latest 'Flying Leads' UK legislation
- High quality cables and connectors deliver consistently repeatable results
- All Bipolar Forceps supplied double packed

### STANDARD BIPOLAR FORCEPS

|             |   |          |
|-------------|---|----------|
| SU770515044 | Standard Bipolar Forceps 150 x 0.5mm, 3m, 4mm Plugs | 20 units |
| SU770520044 | Standard Bipolar Forceps 200 x 0.5mm, 3m, 4mm Plugs | 20 units |
| SU771015044 | Standard Bipolar Forceps 150 x 1mm, 3m, 4mm Plugs   | 20 units |
| SU771520044 | Standard Bipolar Forceps 200 x 1.5mm, 3m, 4mm Plugs | 20 units |
| SU772015044 | Standard Bipolar Forceps 150 x 2mm, 3m, 4mm Plugs   | 20 units |
| SU772020044 | Standard Bipolar Forceps 200 x 2mm, 3m, 4mm Plugs   | 20 units |

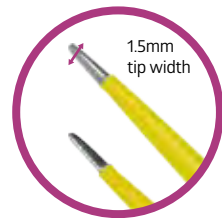

SU772020044

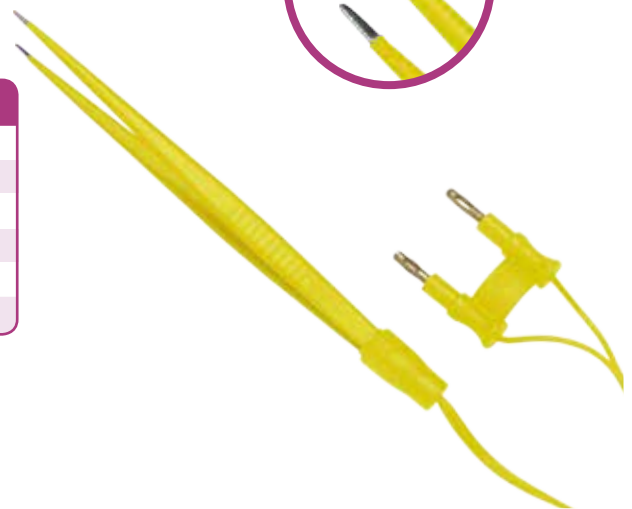

### ADSON BIPOLAR FORCEPS

|             |  |          |
|-------------|--|----------|
| SU790515044 | Adson Bipolar Forceps 150 x 0.5mm, 3m, 4mm Plugs | 20 units |
| SU791015044 | Adson Bipolar Forceps 150 x 1mm, 3m, 4mm Plugs   | 20 units |

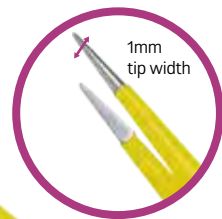

SU791015044



## Bayonet Bipolar Forceps

- Fine stainless steel tips with 1mm or 2mm options
- Adjustable and universal 4mm plug that is tested to comply with the latest 'Flying Leads' UK legislation
- High quality cables and connectors deliver consistently repeatable results
- All Bipolar Forceps are supplied double packed

SU781020044

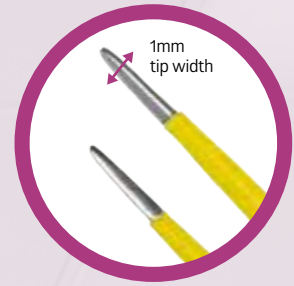

SU782020044

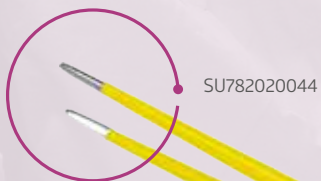

### BAYONET BIPOLAR FORCEPS

|             |  |          |
|-------------|--|----------|
| SU781020044 | Bayonet Bipolar Forceps 200 x 1mm, 3m, 4mm Plugs | 20 units |
| SU782020044 | Bayonet Bipolar Forceps 200 x 2mm, 3m, 4mm Plugs | 20 units |



# Bipolar Forceps

## CAWTHORNE BIPOLAR FORCEPS

|             |  |          |
|-------------|--|----------|
| SU760508044 | Cawthorne Bipolar Forceps 80 x 0.5mm, 3m, 4mm Plugs  | 20 units |
| SU761008044 | Cawthorne Bipolar Forceps 80 x 1mm, 3m, 4mm Plugs    | 20 units |
| SU760511044 | Cawthorne Bipolar Forceps 110 x 0.5mm, 3m, 4mm Plugs | 20 units |
| SU761011044 | Cawthorne Bipolar Forceps 110 x 1mm, 3m, 4mm Plugs   | 20 units |

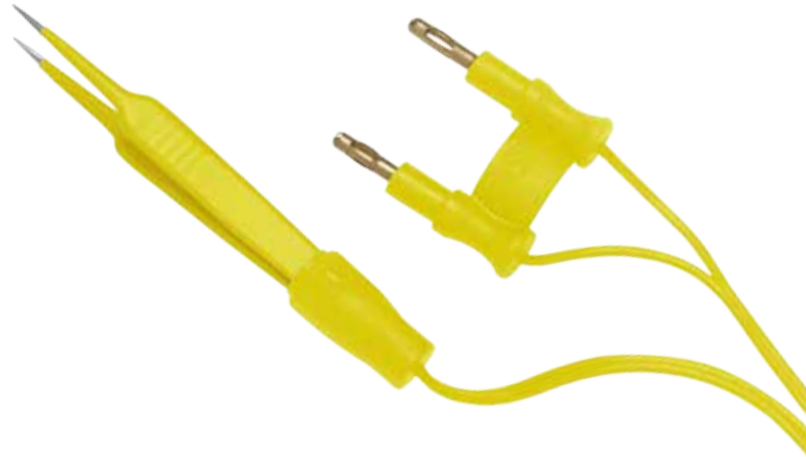

## BIPOLAR CABLE

|            |  |          |
|------------|--|----------|
| SU11443075 | Bipolar Cable, 3m, 4mm pins UK/EU Fitting, single packed | 20 units |
| SU11443076 | Bipolar Cable, 3m, 4mm pins US Fitting, single packed    | 20 units |

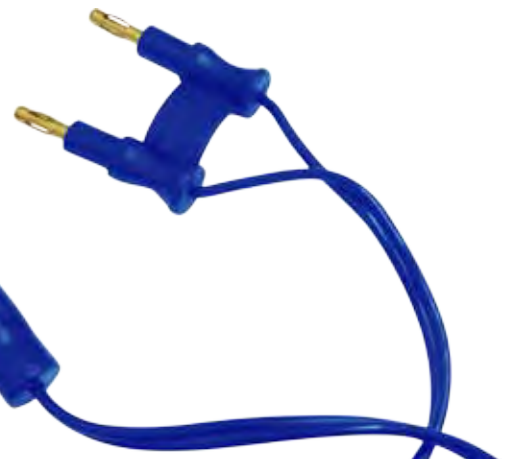

Looking for other Bipolar Forceps?  
For full range contact us on +44 (0)1792 797910

## MONOPOLAR FORCEPS

|             |   |          |
|-------------|---|----------|
| SU671220044 | Monopolar Forceps 200mm Straight x 1.2mm tip serrated | 20 units |
|-------------|---|----------|



# Micro Needle Electrodes



COST

- Straight and angled options available
- Compatible with most finger switches and electro-surgical pencils
- High quality stainless steel and Tungsten needle enables fine and precise tissue dissection
- Improved cutting and coagulation performance, whilst minimising thermal spread

## STAINLESS STEEL ELECTRODES

|            |   |          |
|------------|---|----------|
| MNIS2514   | Micro Needle Electrode, Insulated Stainless Steel Tip, 63 x 14mm        | 25 units |
| MNIS2514-A | Micro Needle Electrode, Insulated Angled Stainless Steel Tip, 70 x 14mm | 25 units |
| MNIS2516   | Micro Needle Electrode, Insulated Stainless Steel Tip, 150 x 16mm       | 25 units |
| MNIS2518   | Micro Needle Electrode, Insulated Stainless Steel Tip, 70 x 18mm        | 25 units |
| MNIS2524   | Micro Needle Electrode, Insulated Stainless Steel Tip, 70 x 22mm        | 25 units |
| MNES2528   | Micro Needle Electrode, Stainless Steel Tip, 70 x 28mm                  | 25 units |

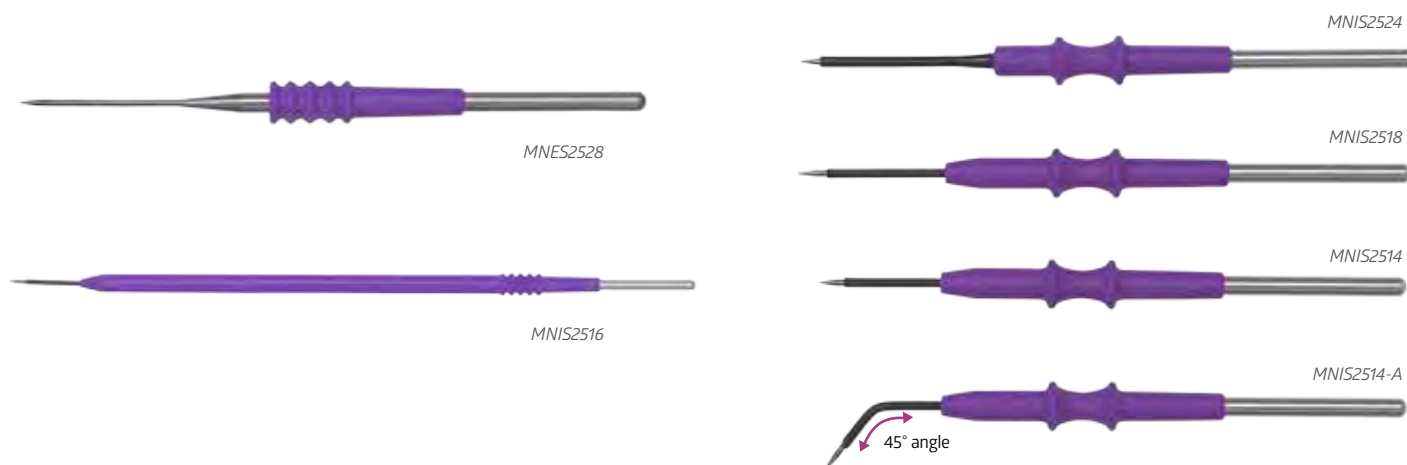
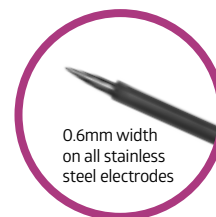

## TUNGSTEN ELECTRODES

|          |  |          |
|----------|--|----------|
| MNET1014 | Micro Needle Electrode, Tungsten Tip, 70 x 14mm            | 10 units |
| MNET1024 | Micro Needle Electrode, Tungsten Tip, 70 x 22mm            | 10 units |
| MNIT1014 | Micro Needle Electrode, Insulated Tungsten Tip, 63 x 14mm  | 10 units |
| MNIT1016 | Micro Needle Electrode, Insulated Tungsten Tip, 150 x 16mm | 10 units |
| MNIT1024 | Micro Needle Electrode, Insulated Tungsten Tip, 70 x 22mm  | 10 units |

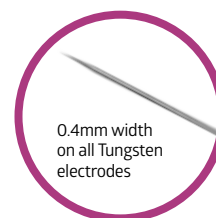

# Clamp Covers

- Soft silicone jaw covers ensure good grip with reduced trauma
- Supplied in three sizes to suit range of procedures
- Custom sterile packs cut to preferred lengths available on request

## STERILE CLAMP COVERS

|         |   |          |
|---------|---|----------|
| CCR2031 | Clamp Cover Red (Small) 50mm, double packed   | 20 units |
| CCW2041 | Clamp Cover White (Med) 120mm, double packed  | 20 units |
| CCB2051 | Clamp Cover Blue (Large) 120mm, double packed | 20 units |

## CLAMP COVERS (NON-STERILE)

|        |                |        |
|--------|----------------|--------|
| SM3030 | Red - Small    | 5 x 1m |
| SM3040 | White - Medium | 5 x 1m |
| SM3050 | Blue - Large   | 5 x 1m |

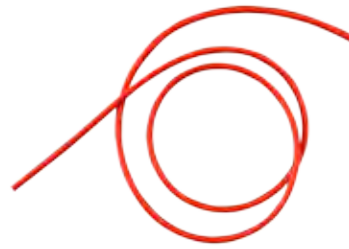

# Silicone Slings

## INCLUDES GREEN COLOUR\*

- Atraumatic oval cross section for less damage during surgery
- Radiopaque and biocompatible medical grade silicone

## SILICONE SLINGS

### 1.5mm Slings

|        |  |          |
|--------|--|----------|
| SM2100 | Multicoloured Slings 1.5mm packed x 5, double packed | 20 units |
| SM2103 | Red Slings 1.5mm, double packed                      | 25 units |
| SM2104 | Blue Slings 1.5mm, double packed                     | 25 units |
| SM2105 | Yellow Slings 1.5mm, double packed                   | 25 units |
| SM2106 | White Slings 1.5mm, double packed                    | 25 units |

### 2mm Slings

|         |  |          |
|---------|--|----------|
| SM2002* | Multicoloured Slings 2mm packed x 5, double packed (includes green colour)     | 20 units |
| SM2008  | Sling Multipack 2mm, (Red x 3, Blue x 3, Yellow x 1, White x 1), double packed | 20 units |
| SM2030  | Red Slings 2mm, double packed  | 25 units |
| SM2040  | Blue Slings 2mm, double packed   | 25 units |
| SM2050  | Yellow Slings 2mm, double packed   | 25 units |
| SM2060  | White Slings 2mm, double packed  | 25 units |

### 5mm Slings

|        |   |          |
|--------|---|----------|
| SM2513 | Red Slings 5mm, individually double packed  | 25 units |
| SM2514 | Blue Slings 5mm, individually double packed | 25 units |

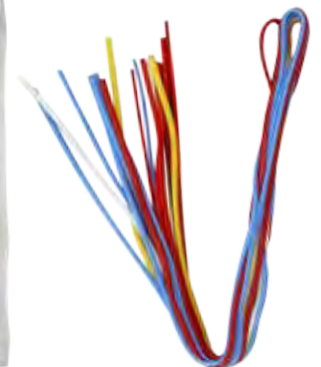

# General and Vascular

£  
COST

## HEPARIN NEEDLE

|         |   |          |
|---------|---|----------|
| HFN2001 | Heparin Flushing Needle 46mm, double packed | 20 units |
| HFN2081 | Heparin Flushing Needle 85mm, double packed | 20 units |



Heparin

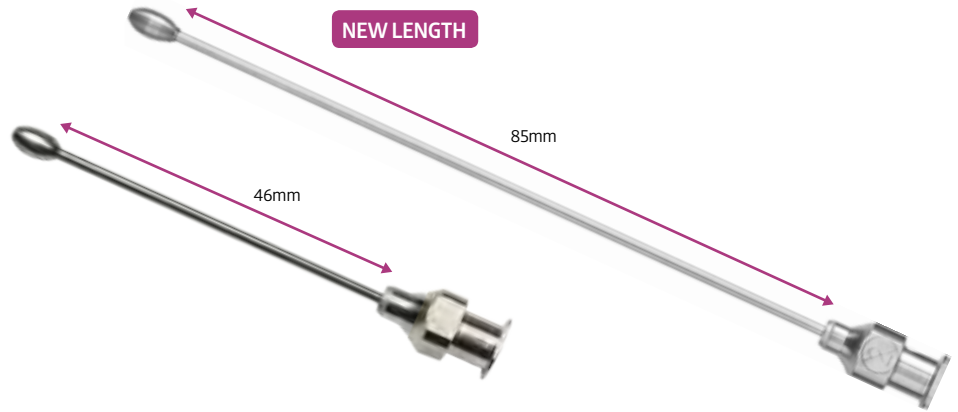

£  
COST

## EXCELLENT VALUE

- Soft jaw covers (shods) provide improved grip for delicate sutures
- Longer length ensure better fit on jaws
- Radiopaque
- Convenient packs of 6 or 10
- Alternative sizes available non-sterile (see Tip Shields for options)
- Range for artery forceps and vascular clamps



## VASCULAR BOOTIES

|           |  |          |
|-----------|--|----------|
| VB5080    | Vascular Booties 2mm x 6, single packed  | 50 units |
| VB5080-D  | Vascular Booties 2mm x 6, double packed  | 50 units |
| VB5080/10 | Vascular Booties 2mm x 10, single packed | 50 units |
| VB5190    | Vascular Booties 1mm x 6, double packed  | 50 units |

**i** For cost benefit information see p33

- Mosquitos with Booties ready for use
- Convenient pack of three pre-shod forceps

## VASCULAR MOSQUITOS

|          |   |          |
|----------|---|----------|
| VMQT2003 | Vascular Mosquito Forceps Straight, 125mm with Booties x 3, double packed | 20 units |
|----------|---|----------|



## UNIQUE RANGE

# Tibbs Arterial Cannula



- Individually packed to avoid wastage
- Easier to use than reprocessing very fine tube lumens
- High quality stainless steel suitable for clinicians to bend shape
- Removes contamination risks through flushing



Large Olive

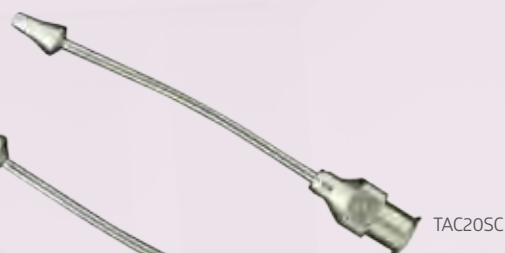

TAC20SC

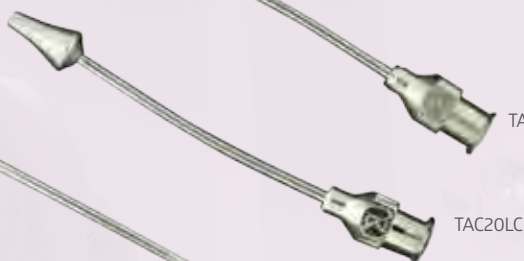

TAC20LC



TAC20XLC



TAC20XXLC



2.5 x 4mm olive



Micro Olive

### TIBBS STANDARD SIZES

|         |  |          |
|---------|--|----------|
| TAC20LC | Tibbs Arterial Cannula Large Cone std length, double packed  | 20 units |
| TAC20SC | Tibbs Arterial Cannula Small Cone std length, double packed  | 20 units |
| TAC20LO | Tibbs Arterial Cannula Large Olive std length, double packed | 20 units |
| TAC20SO | Tibbs Arterial Cannula Small Olive std length, double packed | 20 units |

### TIBBS SPECIAL SIZES

|           |   |          |
|-----------|---|----------|
| TAC20MO   | Tibbs Arterial Cannula Micro Olive 2.5mm OD std length, double packed                         | 20 units |
| TAC20XLC  | Tibbs Arterial Cannula X Large Cone 8mm OD extra long, double packed                          | 20 units |
| TAC20XXLC | Tibbs Arterial Cannula XX Large Cone 12.25mm OD extra long, double packed                     | 20 units |
| TAC2003   | Tibbs Arterial Cannula Set of 3 sizes (Large Olive, Large Cone & X Large Cone), double packed | 20 units |

## Retractors

NEW

### KILNER ALAE HOOK RETRACTOR

KHR2001 Kilner Alae Hook Retractor 85 x 13mm, double packed 20 units



## Vasectomy Sets

- Ideal when local reprocessing is absent
- Readily available to minimise list disruption
- Non-scalpel procedure
- Quick and easy to use

### VASECTOMY SET

VAS1002 Vasectomy set, double packed 10 units

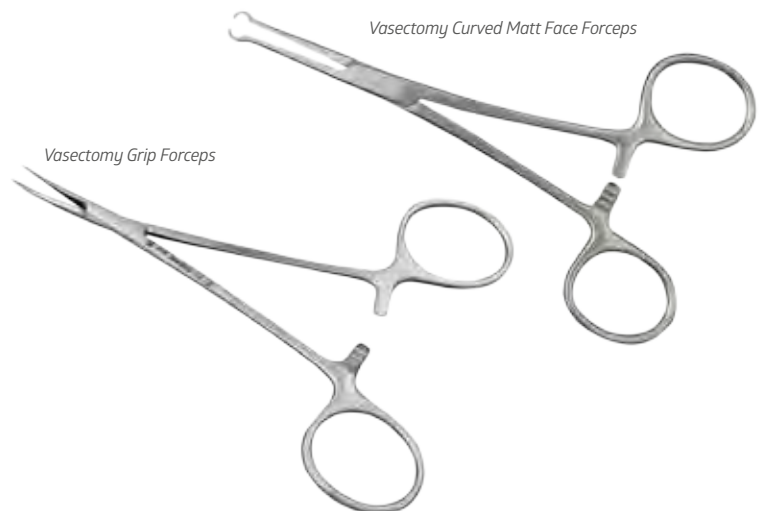
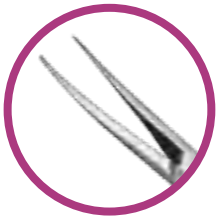

# VNUS Closure and Phlebectomy Hooks



TIME

■ VNUS sets contain 1 Hook and 2 x Micro Mosquito 120mm Curved

## VNUS CLOSURE

|         |  |          |
|---------|--|----------|
| VNS1011 | VNUS Closure Set with Hook size 1 (2mm), double packed   | 10 units |
| VNS1022 | VNUS Closure Set with Hook size 2 (1.5mm), double packed | 10 units |
| VNS1033 | VNUS Closure Set with Hook size 3 (1mm), double packed   | 10 units |

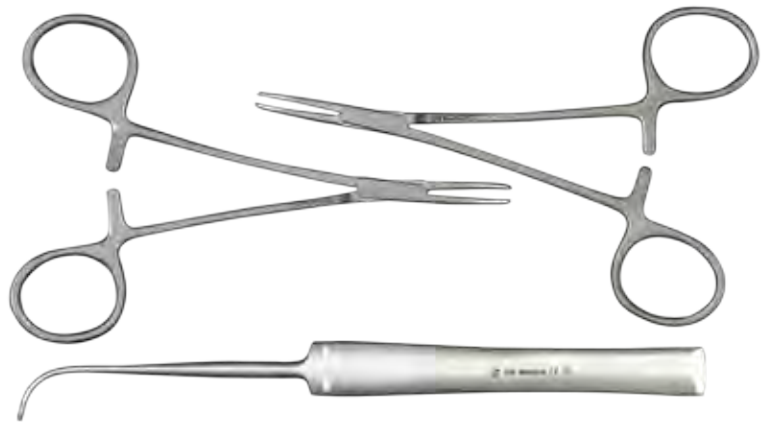

VNS1011

## PHLEBECTOMY HOOKS

|         |  |          |
|---------|--|----------|
| PBH2001 | Phlebectomy Hook Size 1 (2mm), double packed   | 20 units |
| PBH2002 | Phlebectomy Hook Size 2 (1.5mm), double packed | 20 units |
| PBH2003 | Phlebectomy Hook Size 3 (1mm), double packed   | 20 units |

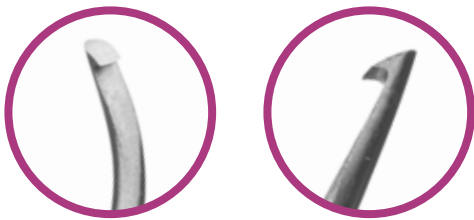

PBH2001



PBH2002



PBH2003

# Suction Handles



- Removes need to clean and reprocess the long narrow lumen

## BELLUCCI SUCTION HANDLES

BLS2001 Bellucci Suction Handle 175 x 2mm OD (6fg), double packed 20 units



**i** Looking for sterile silicone tubing for use with the following? see p30-31



- Effective alternative to reprocessing very long narrow lumen
- Range of sizes from 240mm (6fg) to 550mm (18fg)

## LONG SUCTION HANDLES

### 240mm

BLSF2240 Micro Laryngeal Suction Handle 240 x 2mm OD (6fg), double packed 20 units

### 280mm

BLS2280 Micro Laryngeal Suction Handle 280 x 2mm OD (6fg), double packed 20 units

### 330mm

BLS2330 Micro Laryngeal Suction Handle 330 x 2mm OD (6fg), double packed 20 units

BLSF2339 Micro Laryngeal Suction Handle 330 x 3mm OD (9fg), double packed 20 units

### 360mm

BLSF2369 Micro Laryngeal Suction Handle, 360 x 3mm OD (9fg), double packed 20 units

### 450mm

BLS2450 Bronchoscopy Suction Handle 450 x 4mm OD (12fg), double packed 20 units

### 550mm

BLS2550 Oesophageal Suction Handle 550 x 4mm OD (12fg), double packed 20 units

SGH2001 Sigmoidoscope Suction Handle, 560 x 6mm OD (18fg), double packed 20 units

*Oesophageal*



*Micro Laryngeal*



*Sigmoidoscope*

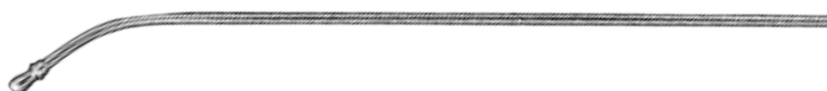



# Frazier Suction Handles

Available without suction control



- Strong construction suitable for bending to shape during procedure
- Single-use avoids the need to restraighten or risk breakage
- Tip options include non-fenestrated, fenestrated with two holes and cross fenestrated with four holes

Supplied straight\*  
Bend to shape for your procedure

\*Excluding 12fg range

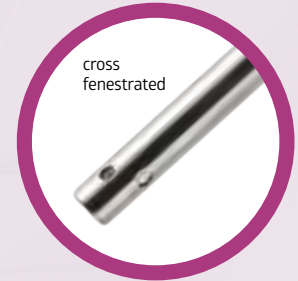
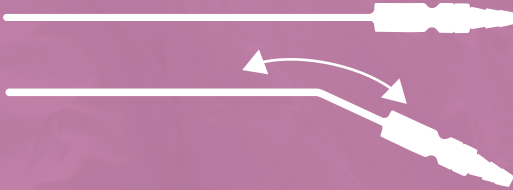

42° bend

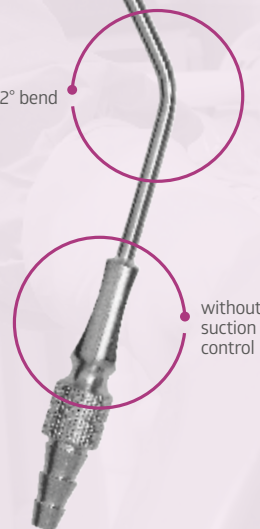

## FRAZIER SUCTION HANDLES

### 2mm (6fg)

|         |   |          |
|---------|---|----------|
| FSH2006 | Frazier Suction Handle 184 x 2mm OD (6fg) straight, double packed                           | 20 units |
| FSF2006 | Frazier Suction Handle 184 x 2mm OD (6fg) straight, fenestrated, double packed              | 20 units |
| FSF2046 | Frazier Suction Handle 184 x 2mm OD (6fg) straight, cross fenestrated, double packed        | 20 units |
| FSN2426 | Frazier Suction Handle 184 x 2mm OD (6fg), 42° bend, without suction control, double packed | 20 units |

### 2.66mm (8fg)

|         |   |          |
|---------|---|----------|
| FSH2008 | Frazier Suction Handle 184 x 2.66mm OD (8fg) straight, double packed                    | 20 units |
| FSF2008 | Frazier Suction Handle 184 x 2.66mm OD (8fg) straight, fenestrated, double packed       | 20 units |
| FSF2048 | Frazier Suction Handle 184 x 2.66mm OD (8fg) straight, cross fenestrated, double packed | 20 units |

### 3mm (9fg)

|         |   |          |
|---------|---|----------|
| FSH2009 | Frazier Suction Handle 184 x 3mm OD (9fg) straight, double packed                           | 20 units |
| FSF2009 | Frazier Suction Handle 184 x 3mm OD (9fg) straight, fenestrated, double packed              | 20 units |
| FSF2049 | Frazier Suction Handle 184 x 3mm OD (9fg) straight, cross fenestrated, double packed        | 20 units |
| FSN2429 | Frazier Suction Handle 184 x 3mm OD (9fg), 42° bend, without suction control, double packed | 20 units |

### 4mm (12fg)

|          |  |          |
|----------|--|----------|
| FSH2012  | Frazier Suction Handle 184 x 4mm OD (12fg), double packed                                    | 20 units |
| FSF2012  | Frazier Suction Handle 184 x 4mm OD (12fg), fenestrated, 150° bend, double packed            | 20 units |
| FSF2412  | Frazier Suction Handle 184 x 4mm OD (12fg), cross fenestrated, 150° bend, double packed      | 20 units |
| FSN24212 | Frazier Suction Handle 184 x 4mm OD (12fg), 42° bend, without suction control, double packed | 20 units |

# Suction Handles



EXTENDED RANGE

- Stainless steel tube with colour coded luer connector for micro suction use
- Also suitable for use with syringe as irrigation device
- Available in 86, 110 and 120mm lengths

## MICRO SUCTION TUBES

|              |  |          |
|--------------|--|----------|
| MSD2001      | Micro Suction Device 86 x 2mm OD (6fg), double packed                                      | 20 units |
| <b>86mm</b>  |  |          |
| MSV508113    | Micro Suction (Verhoeven) Red 86 x 2.3mm OD (13g), double packed                           | 50 units |
| MSV508113R   | Micro Suction (Verhoeven) Red 86 x 2.3mm OD (13g) with Suction Regulator, double packed    | 50 units |
| MSV508114    | Micro Suction (Verhoeven) Green 86 x 2.1mm OD (14g), double packed                         | 50 units |
| MSV508114R   | Micro Suction (Verhoeven) Green 86 x 2.1mm OD (14g) with Suction Regulator, double packed  | 50 units |
| MSV508116    | Micro Suction (Verhoeven) Cream 86 x 1.65mm OD (16g), double packed                        | 50 units |
| MSV508116R   | Micro Suction (Verhoeven) Cream 86 x 1.65mm OD (16g) with Suction Regulator, double packed | 50 units |
| MSV508117    | Micro Suction (Verhoeven) White 86 x 1.47mm OD (17g), double packed                        | 50 units |
| MSV508119    | Micro Suction (Verhoeven) Brown 86 x 1.05mm OD (19g), double packed                        | 50 units |
| <b>110mm</b> |  |          |
| MSV50114     | Micro Suction (Verhoeven) Green 110 x 2.1mm OD (14g), double packed                        | 50 units |
| MSV50117     | Micro Suction (Verhoeven) White 110 x 1.47mm OD (17g), double packed                       | 50 units |
| MSV50119     | Micro Suction (Verhoeven) Brown 110 x 1.05mm OD (19g), double packed                       | 50 units |
| MSV50122     | Micro Suction (Verhoeven) Black 110 x 0.7mm OD (22g), double packed                        | 50 units |
| MSV50127     | Micro Suction (Verhoeven) Clear 110 x 0.4mm OD (27g), double packed                        | 50 units |
| <b>120mm</b> |  |          |
| MSV50214     | Micro Suction (Verhoeven) Green 120 x 2.1mm OD (14g), double packed                        | 50 units |
| MSV50217     | Micro Suction (Verhoeven) White 120 x 1.47mm OD (17g), double packed                       | 50 units |
| MSV50219     | Micro Suction (Verhoeven) Brown 120 x 1.05mm OD (19g), double packed                       | 50 units |
| MSV50222     | Micro Suction (Verhoeven) Black 120 x 0.7mm OD (22g), double packed                        | 50 units |
| MSV50227     | Micro Suction (Verhoeven) Clear 120 x 0.4mm OD (27g), double packed                        | 50 units |



## UNIVERSAL ADAPTER

- House style regulator with control
- Luer connector suitable for Verhoeven and other micro suction tubes

## SUCTION REGULATOR

|          |   |          |
|----------|---|----------|
| DSRP5001 | Suction Regulator Yellow, double packed | 50 units |
|----------|---|----------|

*Tubing and Verhoeven  
not included*

# Suction Handles



## SPECIAL SIZES

- Stainless steel for balance and precision
- Supplied with detachable outer to spread suction
- Ideal when plastic handles are inappropriate
- Available in three lengths 190, 240, 330mm to suit patients from neonates to high BMI adults

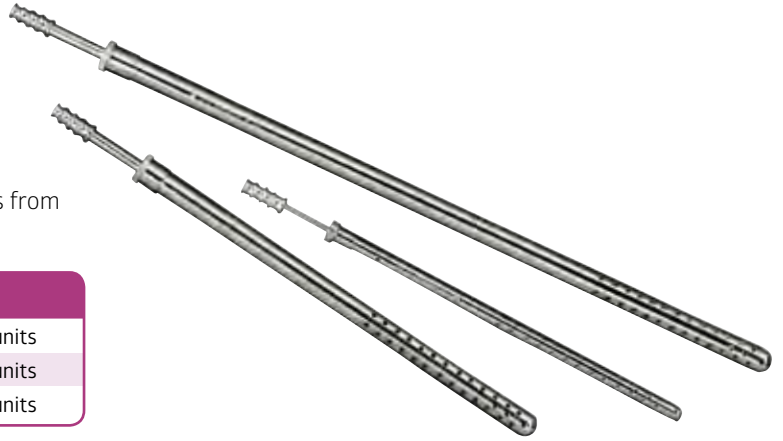

### POOLE SUCTION HANDLE

|          |  |          |
|----------|--|----------|
| PSHN1001 | Poole Suction Handle Neonatal, double packed | 10 units |
| PSH1001  | Poole Suction Handle, double packed          | 10 units |
| PSHL1001 | Poole Suction Handle Long, double packed     | 10 units |



## CHOICE OF ROSES

- Ideal when plastic handles are inappropriate
- Detachable rose with three (YST1000) or six holed modified rose (YST1000R)
- Ideal for tonsillectomy



### YANKAUER SUCTION HANDLE

|          |   |          |
|----------|---|----------|
| YST1000  | Yankauer Suction Handle 305mm with rose, double packed          | 10 units |
| YST1000R | Yankauer Suction Handle 305mm with modified rose, double packed | 10 units |

# Tip Shields

- Supplied non-sterile
- Wide choice of colour, size, and shape
- Cost effective instrument protection
- Protects staff during reprocessing and sterilisation



### TIP SHIELDS

|        |  |           |
|--------|--|-----------|
| SM5010 | Flat 26mm width Black, single packed     | 100 units |
| SM5020 | Flat 13mm width Brown, single packed     | 100 units |
| SM5030 | Flat 6.5mm width Orange, single packed   | 100 units |
| SM5040 | Round 10mm diameter Mauve, single packed | 100 units |
| SM5050 | Round 6mm diameter Yellow, single packed | 100 units |
| SM5060 | Round 4mm diameter Red, single packed    | 100 units |
| SM5070 | Round 3mm diameter Green, single packed  | 100 units |
| SM5080 | Round 2mm diameter Blue, single packed   | 100 units |
| SM5090 | Round 1mm diameter Blue, single packed   | 100 units |

# Tubing Products



## EASY TO USE SIZE GUIDE

- Supplied non-sterile
- Supplied in 15 metre packs for cutting to size
- Suitable for custom procedure trays



### SILICONE TUBING

|         |         |          |               |
|---------|---------|----------|---------------|
| SM105   | ID 0.3  | OD 0.64  | 15m roll      |
| SM135   | ID 0.51 | OD 0.94  | 15m roll      |
| SM155   | ID 0.64 | OD 1.19  | 15m roll      |
| SM175   | ID 0.76 | OD 1.65  | 15m roll      |
| SM205   | ID 1.02 | OD 2.16  | 15m roll      |
| SM235   | ID 1.47 | OD 1.96  | 15m roll      |
| SM265   | ID 1.57 | OD 2.41  | 15m roll      |
| SM285   | ID 1.57 | OD 3.18  | 15m roll      |
| SM305   | ID 1.98 | OD 3.18  | 15m roll      |
| *SM305P | ID 1.98 | OD 3.18  | 15m roll      |
| SM325   | ID 2.65 | OD 4.88  | 15m roll      |
| SM335   | ID 3.35 | OD 4.65  | 15m roll      |
| SM365   | ID 3.18 | OD 6.35  | 15m roll      |
| SM405   | ID 4.8  | OD 7.9   | 15m roll      |
| SM415   | ID 5    | OD 8.3   | 15m roll      |
| SM425   | ID 4.8  | OD 9.5   | 15m roll      |
| SM445   | ID 6.4  | OD 9.5   | 15m roll      |
| SM465   | ID 6.4  | OD 11.1  | 15m roll      |
| SM485   | ID 6.4  | OD 12.7  | 15m roll      |
| SM505   | ID 7.9  | OD 12.7  | 15m roll      |
| SM525   | ID 9.5  | OD 12.7  | 15m roll      |
| SM545   | ID 9.5  | OD 14.3  | 15m roll      |
| SM565   | ID 9.5  | OD 15.9  | 15m roll      |
| SM625   | ID 12.7 | OD 17.5  | 15m roll      |
| SM645   | ID 12.7 | OD 19.05 | 2 x 7.5m roll |
| SM685   | ID 15.9 | OD 22.23 | 2 x 7.5m roll |

\*SM305P is blue pigmented

### SUCTION HANDLE TUBING RECOMMENDATIONS

| Tubing (non-sterile) | Tubing Diameters    | Spigot | Sterile DSTS Code | Suitable for use Suction Handles   |
|----------------------|---------------------|--------|-------------------|--|
| <b>SM405</b>         | 4.8mm ID x 7.9mm OD | 4-6mm  | DSTS40506         | Aspirating Dissectors<br>Bronchoscopy<br>Frazier<br>Magill<br>Microlaryngeal Oesophageal<br>Poole<br>Sinus Suction Regulator |
| <b>SM445</b>         | 6.4mm ID x 9.5mm OD | 7-11mm | DSTS44506         | All of the above (exc Sinus) plus Barron, Schuknecht and Tapered   |

# Sterile Single-Use Silicone Tube Sets

HOW TO USE: First 6 digits + order code followed by inner diameter (ID) and outer diameter (OD) then length (mm) e.g. DST205 + 1004 = DST2051004 (1.02 ID x 2.16 OD) 40mm

| DSTS = Spigot | LENGTH (mm)    |                |    |    |      |     |     |     |        |     |     |     |     |     |         |     |      |      |      |           |           |      |      |      |      |              |    |  |
|---------------|----------------|----------------|----|----|------|-----|-----|-----|--------|-----|-----|-----|-----|-----|---------|-----|------|------|------|-----------|-----------|------|------|------|------|--------------|----|--|
|               | Inner Diameter | Outer Diameter | 15 | 25 | 40   | 75  | 150 | 200 | 250    | 300 | 450 | 515 | 600 | 700 | 750-760 | 800 | 1000 | 1100 | 1200 | 1350-1450 | 1500-1750 | 2000 | 2500 | 3000 | 3600 | 18000 & 4500 |    |  |
| CODE          | mm             | mm             |    |    | 40   |     |     |     |        |     |     |     |     |     |         |     |      |      |      |           |           |      |      |      |      |              |    |  |
| DST105        | 0.30           | 0.64           |    |    |      |     |     |     |        | 03  |     |     |     |     |         |     |      |      |      |           |           |      |      |      |      |              |    |  |
| DST175        | 0.76           | 1.65           |    |    |      |     |     |     |        |     | 05  |     |     |     |         |     |      |      |      |           |           |      |      |      |      |              |    |  |
| DST205        | 1.02           | 2.16           |    |    | 1004 |     |     |     |        |     |     |     |     |     |         |     |      |      |      |           |           |      |      |      |      |              |    |  |
| DST285        | 1.57           | 3.18           |    |    |      |     |     |     | 1 or 2 | 03  | 04  |     |     | 07  |         |     |      |      |      |           |           |      | 30   |      |      |              |    |  |
| DST305        | 1.98           | 3.18           |    |    |      |     |     | 02  |        | 03  | 04P |     |     |     |         |     |      |      |      |           |           |      |      |      |      |              |    |  |
| DST325        | 2.65           | 4.88           |    |    |      |     |     |     |        | 03  |     |     |     |     |         |     |      |      |      |           |           |      |      |      |      |              |    |  |
| DST335        | 3.35           | 4.65           |    |    |      |     | 815 |     |        |     |     |     |     |     |         |     |      |      |      |           |           |      |      |      |      |              |    |  |
| DST365        | 3.20           | 6.40           |    |    |      |     |     | 02  |        |     |     |     |     |     |         |     |      |      |      |           |           |      |      |      |      |              |    |  |
| DSTS365       | 3.20           | 6.40           |    |    |      |     |     | 02  |        |     |     |     |     |     |         | 08  |      | 20   |      |           |           |      |      |      |      |              |    |  |
| DST405        | 4.80           | 7.90           |    |    |      |     | 015 |     |        | 03  |     |     | 06  |     |         |     | 10   |      | 12   | 13        | 15 or 17  |      | 25   |      |      | 36           | 2M |  |
| DSTS365       | 4.80           | 7.90           |    |    |      |     |     |     |        |     |     |     | 06  |     |         |     |      |      |      |           |           |      |      |      |      |              |    |  |
| DST415        | 5.00           | 8.30           |    |    |      |     |     |     |        |     |     |     | 06  |     |         |     |      |      | 12   |           | 15        |      | 25   |      |      | 36           |    |  |
| DST425        | 4.80           | 9.50           |    |    |      |     |     |     |        |     |     |     | 06  |     |         |     |      |      | 12   |           |           |      | 25   |      |      | 36           |    |  |
| DSTS425       | 4.80           | 9.50           |    |    |      |     |     |     |        |     |     |     |     |     |         |     |      |      | 12   |           |           |      |      |      |      | 36           | 2M |  |
| DST445        | 6.40           | 9.50           |    |    |      |     |     |     |        | 03  |     |     |     | 07  |         |     | 10   |      |      |           |           |      | 25   |      |      | 36           |    |  |
| DSTS445       | 6.40           | 9.50           |    |    |      |     |     |     |        |     |     |     | 06  |     |         |     | 10   |      |      |           |           |      |      |      |      |              |    |  |
| DST465        | 6.40           | 11.10          |    |    |      |     |     |     |        |     | 04  |     |     | 07  |         |     | 10   |      |      |           |           |      |      |      |      |              |    |  |
| DST485        | 6.40           | 12.70          |    |    |      |     |     |     |        |     |     |     |     |     |         |     |      |      |      |           |           |      |      |      |      | 36           |    |  |
| DST505        | 7.90           | 12.70          |    |    |      |     |     |     |        |     |     |     |     |     |         |     |      |      |      |           |           |      |      |      |      |              |    |  |
| DST525        | 9.50           | 12.70          |    |    |      |     |     |     |        |     |     |     |     |     |         |     |      |      |      |           |           |      |      |      |      |              |    |  |
| DST545        | 9.50           | 12.70          |    |    |      | 007 |     |     |        |     |     |     |     |     |         |     |      |      |      |           |           |      |      |      |      |              |    |  |
| DSTS545       | 9.50           | 14.30          |    |    |      |     |     |     | 02     |     |     |     |     |     |         |     |      |      |      |           |           |      |      |      |      |              |    |  |
| DST565        | 9.50           | 15.90          |    |    |      |     |     |     |        |     |     |     |     |     |         |     |      |      |      |           |           |      |      |      |      |              |    |  |
| DST625        | 12.70          | 17.50          |    |    |      |     |     |     |        |     |     |     |     |     |         |     |      |      |      |           |           |      |      | 25   |      |              |    |  |
| PACK SIZE KEY | 10 (units)     | 20 (units)     |    |    |      |     |     |     |        |     |     |     |     |     |         |     |      |      |      |           |           |      |      |      |      |              |    |  |

ALL DOUBLE PACKED EXCEPT DST40576-S  
Custom sizes can be requested

# Tubing Products



EXTENDED RANGE

- Sterile for extra confidence where lengths over 270mm are impossible to validate
- Cost effective alternative to in-house production
- Full range of tube sizes cut to consistent lengths
- Tailored to suit needs including mixed packs
- Selected tube sets available with Spigot



## STERILE SILICONE TUBE SETS

### DST105

DST10503 Sterile Silicone Tube 0.3 ID x 0.64 OD x 300mm long, double packed 10 units

### DST175

DST17505 Sterile Silicone Tube 0.76 ID x 1.65 OD x 515mm long, double packed 10 units

### DST205

DST2051004 Sterile Silicone DCR Tube 1.02 ID x 2.16 OD x 40mm long, double packed 10 units

DST20503 Sterile Silicone Tube 1.02 ID x 2.16 OD x 300mm long, double packed 10 units

DST20510 Sterile Silicone Tube 1.02 ID x 2.16 OD x 1000mm long, double packed 10 units

### DST285

DST2851 Sterile Silicone Tube 1.57 ID x 3.18 OD x 250mm long, double packed 10 units

DST2852 Sterile Silicone Tube 1.57 ID x 3.18 OD x 250mm long 2 pieces, double packed 10 units

DST28503 Sterile Silicone Tube 1.57 ID x 3.18 OD x 300mm long, double packed 10 units

DST28504 Sterile Silicone Tube 1.57 ID x 3.18 OD x 450mm long, double packed 10 units

DST28507 Sterile Silicone Tube 1.57 ID x 3.18 OD x 700mm long, double packed 10 units

DST28530 Sterile Silicone Tube 1.57 ID x 3.18 OD x 3000mm long, double packed 20 units

### DST305

DST305002 Sterile Silicone Tube 1.98 ID x 3.18 OD x 25mm long, double packed 10 units

DST30502 Sterile Silicone Tube 1.98 ID x 3.18 OD x 200mm long, double packed 10 units

DST30503 Sterile Silicone Tube 1.98 ID x 3.18 OD x 300mm long, double packed 10 units

DST30504P Sterile Silicone Tube 1.98 ID x 3.18 OD x 450mm long blue, double packed 20 units

### DST325

DST325002 Sterile Silicone Tube 2.65 ID x 4.88 OD x 25mm long, double packed 10 units

DST32503 Sterile Silicone Tube 2.65 ID x 4.88 OD x 300mm long, double packed 10 units

### DST335

DST335815 Sterile Silicone Tube 3.35 ID x 4.65 OD x 150mm long x 8 pieces, double packed 20 units

### DST365

DST36502 Sterile Silicone Tube 3.2 ID x 6.4 OD x 200mm long, double packed 20 units

DST36502 Sterile Silicone Tube 3.2 ID x 6.4 OD x 200mm long with Spigot, double packed 20 units

DST36508 Sterile Silicone Tube 3.2 ID x 6.4 OD x 800mm long, double packed 10 units

DST36511 Sterile Silicone Tube 3.2 ID x 6.4 OD x 1100mm long, double packed - House 20 units

DST36520 Sterile Silicone Tube 3.2 ID x 6.4 OD x 2000mm long, double packed 10 units

DST36536 Sterile Silicone Tube 3.2 ID x 6.4 OD x 3600mm long, double packed 10 units

### DST445

DST44530 Sterile Silicone Tube 6.4 ID x 9.5 OD x 3000mm long, double packed 20 units

## STERILE TUBING AND SPIGOT STARTER PACKS

| Code      | Description   | Pack size |
|-----------|---|-----------|
| DSTS40506 | Sterile Silicone Tube 4.8mm ID x 7.9mm OD x 600mm long with Spigot, double packed | 10 units  |
| DSTS44506 | Sterile Silicone Tube 6.4mm ID x 9.5mm OD x 600mm long with Spigot, double packed | 10 units  |

## Tube Dimensions

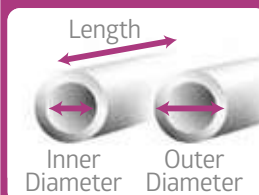

## STERILE SILICONE TUBE SETS (CONTINUED)

### DST405

|            |   |          |
|------------|---|----------|
| DSTS40506  | Sterile Silicone Tube 4.8 ID x 7.9 OD x 600mm long with Spigot, double packed           | 10 units |
| DST405015  | Sterile Silicone Tube 4.8 ID x 7.9 OD x 150mm long, double packed                       | 10 units |
| DST40503   | Sterile Silicone Tube 4.8 ID x 7.9 OD x 300mm long, double packed                       | 10 units |
| DST40506   | Sterile Silicone Tube 4.8 ID x 7.9 OD x 600mm long, double packed                       | 10 units |
| DST40576-S | Sterile Silicone Tube 4.8 ID x 7.9 OD x 760mm long, double packed                       | 10 units |
| DST40510   | Sterile Silicone Tube 4.8 ID x 7.9 OD x 1000mm long, double packed                      | 10 units |
| DST40512   | Sterile Silicone Tube 4.8 ID x 7.9 OD x 1200mm long, double packed                      | 10 units |
| DST40513   | Sterile Silicone Tube 4.8 ID x 7.9 OD x 1350mm long, double packed                      | 20 units |
| DST40515   | Sterile Silicone Tube 4.8 ID x 7.9 OD x 1500mm long, double packed                      | 20 units |
| DST40517   | Sterile Silicone Tube 4.8 ID x 7.9 OD x 1750mm long, double packed                      | 20 units |
| DST4052M   | Sterile Silicone Tube 4.8 ID x 7.9 OD lengths 1 x 1.8m & 1 x 0.45m, double mixed packed | 20 units |
| DST40525   | Sterile Silicone Tube 4.8 ID x 7.9 OD x 2500mm long, double packed                      | 20 units |
| DST40536   | Sterile Silicone Tube 4.8 ID x 7.9 OD x 3600mm long, double packed                      | 20 units |

### DST415

|          |  |          |
|----------|--|----------|
| DST41506 | Sterile Silicone Tube 5.0 ID x 8.3 OD x 600mm long, double packed  | 10 units |
| DST41512 | Sterile Silicone Tube 5.0 ID x 8.3 OD x 1200mm long, double packed | 20 units |
| DST41515 | Sterile Silicone Tube 5.0 ID x 8.3 OD x 1500mm long, double packed | 20 units |
| DST41525 | Sterile Silicone Tube 5.0 ID x 8.3 OD x 2500mm long, double packed | 20 units |
| DST41536 | Sterile Silicone Tube 5.0 ID x 8.3 OD x 3600mm long, double packed | 20 units |

### DST425

|           |   |          |
|-----------|---|----------|
| DST42512  | Sterile Silicone Tube 4.8 ID x 9.5 OD x 1200mm long, double packed                      | 20 units |
| DSTS42576 | Sterile Silicone Tube 4.8 ID x 9.5 OD x 760mm long with Spigot, double packed           | 10 units |
| DST4252M  | Sterile Silicone Tube 4.8 ID x 9.5 OD lengths 1 x 1.8m & 1 x 0.45m, double mixed packed | 20 units |
| DST42536  | Sterile Silicone Tube 4.8 ID x 9.5 OD x 3600mm long, double packed                      | 10 units |

### DST445

|           |  |          |
|-----------|--|----------|
| DSTS44506 | Sterile Silicone Tube 6.4 ID x 9.5 OD x 600mm long with Spigot, double packed  | 10 units |
| DST44503  | Sterile Silicone Tube 6.4 ID x 9.5 OD x 300mm long, double packed              | 10 units |
| DST44507  | Sterile Silicone Tube 6.4 ID x 9.5 OD x 700mm long, double packed              | 10 units |
| DST44510  | Sterile Silicone Tube 6.4 ID x 9.5 OD x 1000mm long, double packed             | 10 units |
| DSTS44510 | Sterile Silicone Tube 6.4 ID x 9.5 OD x 1000mm long with Spigot, double packed | 10 units |
| DST44514  | Sterile Silicone Tube 6.4 ID x 9.5 OD x 1450mm long, double packed             | 10 units |
| DST44515  | Sterile Silicone Tube 6.4 ID x 9.5 OD x 1500mm long, double packed             | 20 units |
| DST44525  | Sterile Silicone Tube 6.4 ID x 9.5 OD x 2500mm long, double packed             | 20 units |
| DST44536  | Sterile Silicone Tube 6.4 ID x 9.5 OD x 3600mm long, double packed             | 20 units |

### DST465

|          |   |          |
|----------|---|----------|
| DST46504 | Sterile Silicone Tube 6.4 ID x 11.1 OD x 450mm long, double packed  | 20 units |
| DST46507 | Sterile Silicone Tube 6.4 ID x 11.1 OD x 750mm long, double packed  | 20 units |
| DST46510 | Sterile Silicone Tube 6.4 ID x 11.1 OD x 1000mm long, double packed | 20 units |
| DST46536 | Sterile Silicone Tube 6.4 ID x 11.1 OD x 3600mm long, double packed | 10 units |

### DST485

|          |   |          |
|----------|---|----------|
| DST48525 | Sterile Silicone Tube 6.4 ID x 12.7 OD x 2500mm long, double packed | 10 units |
| DST48536 | Sterile Silicone Tube 6.4 ID x 12.7 OD x 3600mm long, double packed | 10 units |

### DST505

|          |   |          |
|----------|---|----------|
| DST50515 | Sterile Silicone Tube 7.9 ID x 12.7 OD x 1500mm long, double packed | 10 units |
|----------|---|----------|

### DST525

|          |   |          |
|----------|---|----------|
| DST52536 | Sterile Silicone Tube 9.5 ID x 12.7 OD x 3600mm long, double packed | 10 units |
|----------|---|----------|

### DST545

|           |  |          |
|-----------|--|----------|
| DST545007 | Sterile Silicone Tube 9.5 ID x 14.3 OD x 75mm long, double packed              | 10 units |
| DSTS54502 | Sterile Silicone Tube 9.5 ID x 14.3 OD x 250mm long with Spigot, double packed | 10 units |

### DST565

|          |   |          |
|----------|---|----------|
| DST56515 | Sterile Silicone Tube 9.5 ID x 15.9 OD x 1500mm long, double packed | 10 units |
|----------|---|----------|

### DST625

|            |  |          |
|------------|--|----------|
| DST6250015 | Sterile Silicone Tube 12.7 ID x 17.5 OD x 15mm long, double packed   | 20 units |
| DST62517   | Sterile Silicone Tube 12.7 ID x 17.5 OD x 1750mm long, double packed | 10 units |
| DST62525   | Sterile Silicone Tube 12.7 ID x 17.5 OD x 2500mm long, double packed | 20 units |

## Others



- Sterile for extra confidence
- Cost effective alternative to in-house production
- Latex free to replace elastic bands
- Customised options available

### SILICONE BANDS

DSB3211-S Silicone Bands 2.16 x 110mm diameter x 3, single packed 20 units



### BLUE CLAMPS

DBC5051-S Blue Clamp Medioplast, single packed 10 x 5 units  
 DBC2051-S Blue Clamp Medioplast, single packed 20 x 1 unit

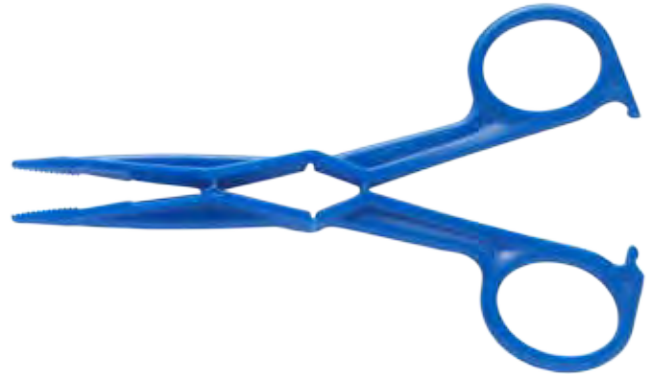

### UNIVERSAL ADD ON

#### SCALPEL BLADE HANDLES

SBH2031 Scalpel Blade Handle No 3, double packed 20 units

#### COMING SOON

SBH2041 Scalpel Blade Handle No 4, double packed 20 units



## Scope Warmer



TIME



COST

### THEATRE EFFICIENCY

- Simple preheating to eliminate condensation
- Secures the surgeon's vision
- Warms full scope length to 37°C within 90 seconds, staying above body temperature for 120 minutes
- Long-acting to avoid disruption or repeated defogging

### SCOPE WARMER

31SW10 ClearView Anti-Fog Scope Warmer, sterile packed for single-use 10 units

31SW30 ClearView Anti-Fog Scope Warmer, sterile packed for single-use 30 units

Click disk to start warming







TIME



LIFE



COST

# Vascular Booties

Protect Sutures

## Savings benefits of single-use instruments

**TIME** = Comparable to alternatives

**LIFE** = Comparable to alternatives

**COST** = Savings of 33% per patient

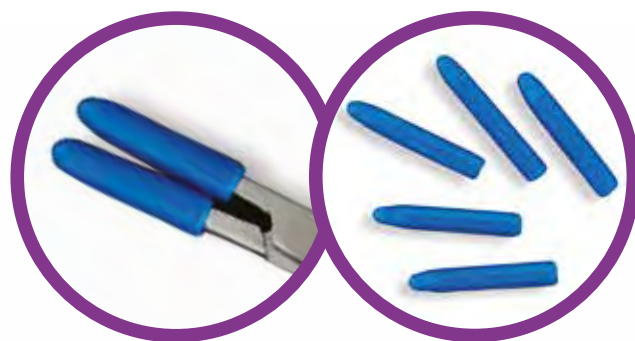

**Annual potential saving up to £1,000**

### Current Treatment

- In vascular and cardiovascular surgery “boots” or “shods” are used on mosquito forceps to protect the suture from kinking and breakage
- Vascular surgeons typically require three pairs of boots and cardiovascular need five pairs for a larger number of vessel connections
- Commonly, many units use sterile packs for each patient
- In some cases these are presented in a tray format supposedly to make it easier to place on the forceps. This costs about £1.00 per patient and generates additional waste material

### DTR Medical's Saving Alternative

- DTR Medical's Vascular Booties are available in sterile pouches containing 6 or 10 booties for individual vascular or cardiovascular cases
- The peel pouch can quickly be opened onto the sterile field and the boots applied easily to the forceps
- There is no extra packaging
- Comparative costing can be confusing because of different case quantities (packs of 10 vs. 50) and for this reason it is recommended to look at the cost per patient in the first instance

| Item                           | Suture boots | Vascular booties       |
|--------------------------------|--------------|------------------------|
| Cost per patient for 6 boots   | £3           | £2.02                  |
| Saving per patient             |              | £0.98                  |
| Estimated 20 patients per week |              | 1000 patients per year |
| <b>Annual Saving</b>           |              | <b>£980.00</b>         |

## “Supporting visibility, quality and safety in your supply chain”\*\*

Our instruments' packaging features the latest machine readable GS1-standard barcoded labels for product traceability.

The newly incorporated labelling technology is a timely development with an increasing number of health providers worldwide adopting an 'eProcurement' strategy and will provide machine readable product information on all labels to meet expected EU and other regulators demands.

### Associated benefits include:

- Improve patient care and reduce costs
- Improve stock control
- One global language
- Accurately track equipment

*“Unique device identification (UDI) compliance represents a significant development for our customers. Automation of information flow will have influences across the whole purchasing and supply process, providing the benefits of superior instrument traceability and improved patient safety.”*

*“We are working closely with Kodit UDI software to provide our labelling solutions to meet the latest international regulations and we serve as a reference site for other manufacturers to learn from.”*

**Andrew Davidson**  
(Managing Director of DTR Medical)

For more information on our new product labelling, please contact Customer Services on +44 (0) 1792 797910 or [info@dtrmedical.com](mailto:info@dtrmedical.com)

\*\* - GS1 – Global Traceability Standards

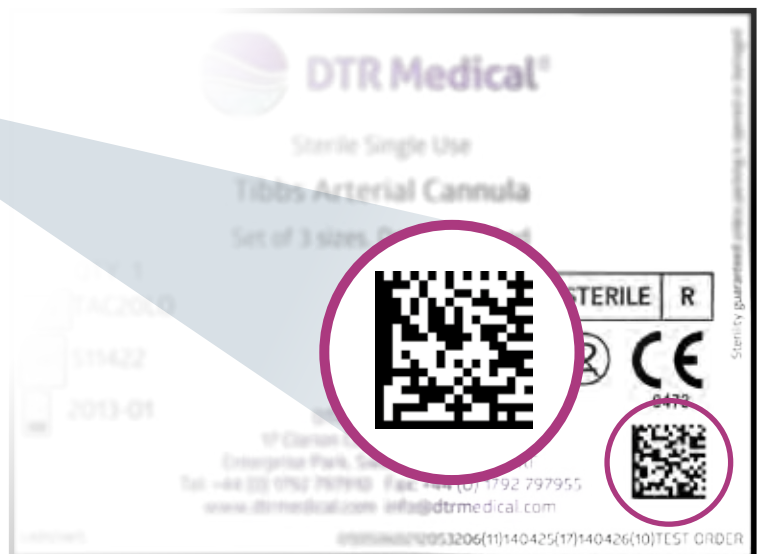



medical  
sales &  
service

**A:** 38 Hector Street OSBORNE PARK WA 6017

**T:** 08 9361 0843 | **F:** 08 9470 3647

**E:** [medsales@medsales.com.au](mailto:medsales@medsales.com.au) | **W:** [www.medsales.com.au](http://www.medsales.com.au)