

HRKK05 12/24 100-120V

DBK's knowledge of thermal management gives us the experience to guide and support you with your technical challenges - we can manage the complete project from concept to full production release.

Specification Table	
	Description
Marking	DBK HRKK05 12/24 100-120V Date Code
Sample Reference	VS13121
Voltage (V)	100-120 VAC
Power	850W +5/-10% 3.3m/sec 25±2°C 115V
Inrush Current	≤17A@115V

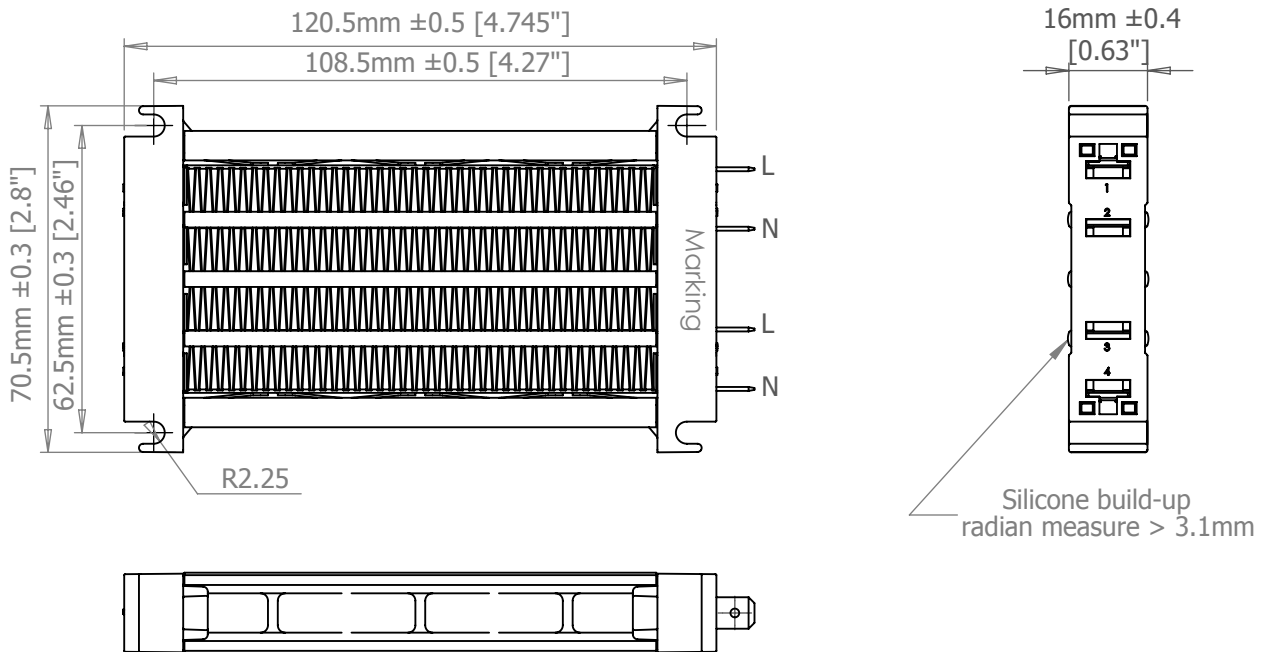

DBK 012918. This information is subject to change without notice. Data is given for illustration purposes only and does not release the customer from independent application tests.