

TABLE OF CONTENTS

- Introduction.....1
- General Safety Rules.....2
- Symbols.....3
- Technical Specifications.....4
- Assembly Instructions.....5
- Maintenance.....7
- Customer Service Information.....7

INTRODUCTION

The Rogers Athletic Mod Sled has been designed and manufactured with safety, performance and dependability as top priorities, making it easy to operate and maintain.

The care you give your Mod Sled will greatly determine your satisfaction with its performance and service life. Careful study of this manual is encouraged to obtain a thorough understanding of your new Mod Sled and its functions and maintenance.

If your manual becomes lost or destroyed, Rogers Athletic will gladly provide you with a new copy. Should you require additional information or assistance, please feel free to contact us at 1-800-457-5337.

BECAUSE ROGERS ATHLETIC MAINTAINS AN ONGOING PROGRAM OF
PRODUCT DEVELOPMENT AND IMPROVEMENT, WE RESERVE THE RIGHT
TO MAKE IMPROVEMENTS IN DESIGN OR CHANGES IN SPECIFICATIONS
WITHOUT INCURRING ANY OBLIGATIONS TO INSTALL THEM ON UNITS
PREVIOUSLY SOLD.

GENERAL SAFETY RULES



WARNING!







READ AND UNDERSTAND ALL INSTRUCTIONS.

Failure to follow all instructions listed below may result in serious personal injury.

SAVE THESE INSTRUCTIONS

- **Supervision of athletes while using the equipment is recommended.** Horse play such as climbing on the machine or using the machine for unintended purpose can result in injuries.
- **Athletes should be oriented in the proper use of the equipment.**
- **Athletes should be properly fit to engage in a workout regimen.** Obtaining a medical exam prior to beginning any training program is recommended. If an athlete feels faint, dizzy, or experiences pain at any time while exercising, they should stop exercising and consult a physician.
- **Inspect equipment prior to use.** DO NOT use if it appears damaged or inoperable.
- **This Product Information Packet is an integral part of this machine.** Save these instructions. If they are lost or damaged or if you would like another copy, a copy can be downloaded from www.RogersAthletic.com
- **Reading the Product Information Packet is recommended.** Failure to read this Packet is considered a misuse of this equipment.
- **Warning labels are an integral part of this equipment.** Become familiar with all caution/warning labels and never cover or deface caution/warning labels.
- **Deploy the equipment allowing sufficient room for safe access to the machine, adequate room for the coaches to stand and to ensure that the machine or players do not collide with a wall, another machine, or other players through the entire training exercise.**
- **Unit is designed for training multiple offensive and defensive drills with proper technique.** Do not use Mod Sled for anything other than its approved purpose.
- **Equipment is designed for use by one person per pad at a time.** Keeping other athletes and spectators away from the machines during use is recommended.
- **Design and execute training drills to avoid players from attempting to run through the same gap between the sled units simultaneously.** Colliding players could come in contact with the sled unit and/or connecting link resulting in an injury.
- **When not in use, store this equipment in a secure controlled area.** Unsupervised and/or inappropriate use of this equipment could result in serious injury.

SYMBOLS

	<p>Safety Alert: Precautions that involve your safety.</p>				
<table border="1"><tr><td colspan="2" data-bbox="215 491 597 533">⚠ WARNING</td></tr><tr><td data-bbox="215 533 386 720"></td><td data-bbox="386 533 597 720"><p>Store in secure area. Inappropriate use of this equipment could result in serious injury.</p></td></tr></table>	⚠ WARNING			<p>Store in secure area. Inappropriate use of this equipment could result in serious injury.</p>	<p>Store this equipment in a secure, controlled area: Unsupervised and/or inappropriate use of this equipment could result in serious injury.</p>
⚠ WARNING					
	<p>Store in secure area. Inappropriate use of this equipment could result in serious injury.</p>				
<table border="1"><tr><td data-bbox="199 768 394 968"></td><td data-bbox="394 768 613 968">⚠ CAUTION Pinch Point. Keep hands and fingers clear.</td></tr></table>		⚠ CAUTION Pinch Point. Keep hands and fingers clear.	<p>Pinch Point Symbol: Failure to keep hands away from pinch points will result in personal injury.</p>		
	⚠ CAUTION Pinch Point. Keep hands and fingers clear.				

ROGERS ATHLETIC MOD SLED SPECIFICATIONS

MOD SLED (PART # 411301 – 411307)

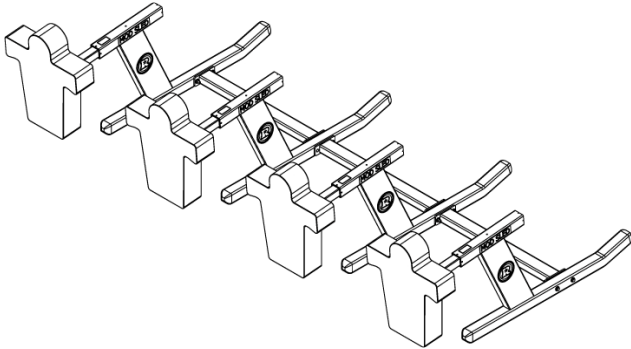

Weight (w/o pads) & Width:

1 man - 295 lbs (134 kg); Width 44" (112 cm)

2 man = 415 lbs (189 kg); W. 60" (152 cm)

3-7 man = + 215 lbs (98 kg) each; W. + 54" (137 cm) each

Height: 36" (91 cm) without pad

Depth: 90" (228 cm) without pad

- Modular design allows easy upgrading by adding links and runners to your current Mod Sled setup.
- Heavy weight increases realism of blocking drills.
- Energy-absorbing material responds to individual effort developing good foot base a must in order to compress the unique spring mechanism and drive the sled.
- Ground-hugging framework allows players to run through on defensive drills.
- Develops good technique for both offensive and defensive players.
- Several different types of pads are adaptable to the Mod Sled. Pads attach with a single pin so pad won't rise or twist when hit.
- Mod Sled optional accessories are Pivoting Pad Adapter, Coach's Platform, and Mod Sled Wheel Kit.
 - Pivoting Pad Adapter allows the pad to rotate horizontally providing a more realistic situation for practice.
 - The mod Sled Wheel Kit is for moving the Mod Sled more easily or for storage.
 - The Coach's Platform allows the coach to watch the force and technique of each player as they use the Mod Sled. It also adds weight to increase leg drive difficulty.
- End Caps welded -not riveted- on so they can't fall off and prevent water damage.
- Flat runners minimize grass and artificial turf wear.

Mod Sled Construction, Finish, and Hardware

- Constructed of ASTM specified steel.
- Baked-on powder coat finish.
- Pads covered with durable weather-resistant vinyl.
- Zinc-plated hardware.

ROGERS ATHLETIC JV MOD SLED SPECIFICATIONS

JV MOD SLED (PART # 41 1322 – 41 1327)

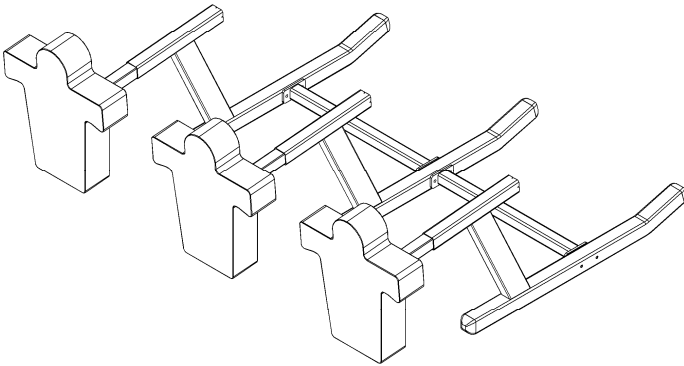

Weight (w/o pads) & Width:

2 man = 328 lbs (149 kg); W. 48" (122 cm)

3-7 man = + 179 lbs (81 kg) each; W. + 36" (91 cm) each

Height: 36" (91cm) without pad

Depth: 90" (228cm) without pad

- Modular design allows easy upgrading by adding links and runners to your current Mod Sled setup.
- Heavy weight increases realism of blocking drills.
- Energy-absorbing material responds to individual effort developing good foot base a must in order to compress the unique spring mechanism and drive the sled.
- Ground-hugging framework allows players to run through on defensive drills.
- Develops good technique for both offensive and defensive players.
- Several different types of pads are adaptable to the Mod Sled. Pads attach with a single pin so pad won't rise or twist when hit.
- Mod Sled optional accessories are Pivoting Pad Adapter, Coach's Platform, and Mod Sled Wheel Kit.
 - Pivoting Pad Adapter allows the pad to rotate horizontally providing a more realistic situation for practice.
 - The mod Sled Wheel Kit is for moving the Mod Sled more easily or for storage.
 - The Coach's Platform allows the coach to watch the force and technique of each player as they use the Mod Sled. It also adds weight to increase leg drive difficulty.
- End Caps welded -not riveted- on so they can't fall off and prevent water damage.
- Flat runners minimize grass and artificial turf wear.

ROGERS ATHLETIC YOUTH MOD SLED SPECIFICATIONS

JV MOD SLED (PART # 41 1337 – 41 1331)

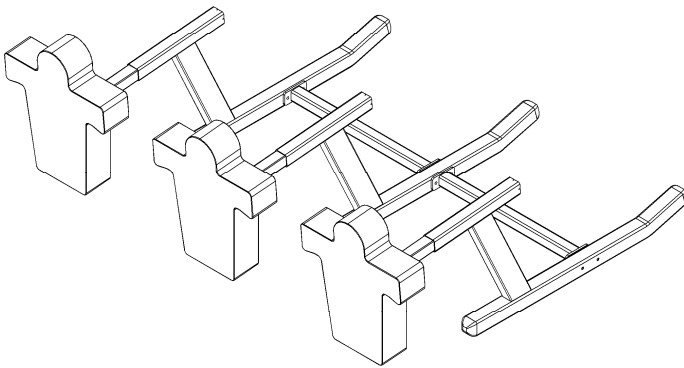

Weight (w/o pads) & Width:

2 man = 285 lbs (130kg); W. 48" (122cm)

3-7 man = + 135 lbs (61kg) each; W. + 36" (91cm) each

Height: 35" (89cm) without pad

Depth: 85" (216cm) without pad

- Modular design allows easy upgrading by adding links and runners to your current Mod Sled setup.
- Heavy weight increases realism of blocking drills.
- Energy-absorbing material responds to individual effort developing good foot base a must in order to compress the unique spring mechanism and drive the sled.
- Ground-hugging framework allows players to run through on defensive drills.
- Develops good technique for both offensive and defensive players.
- Several different types of pads are adaptable to the Mod Sled. Pads attach with a single pin so pad won't rise or twist when hit.
- Mod Sled optional accessories are Pivoting Pad Adapter, Coach's Platform, and Mod Sled Wheel Kit.
 - Pivoting Pad Adapter allows the pad to rotate horizontally providing a more realistic situation for practice.
 - The mod Sled Wheel Kit is for moving the Mod Sled more easily or for storage.
 - The Coach's Platform allows the coach to watch the force and technique of each player as they use the Mod Sled. It also adds weight to increase leg drive difficulty.
- End Caps welded -not riveted- on so they can't fall off and prevent water damage.
- Flat runners minimize grass and artificial turf wear.

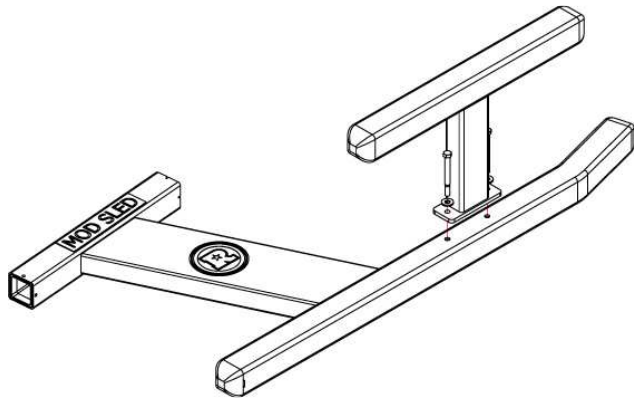
1

Note:
For 2 – 7 man Mod Sled setups skip steps 1 & 2

Lay Mod Sled Runner on its side. Line up holes from the Outrigger with holes on the runner and use (2) 5/8" x 6" bolts and (2) 5/8" washers to hold it in place. Then flip runner right side up so outrigger also lays on the ground. Push bolts the rest of the way through.

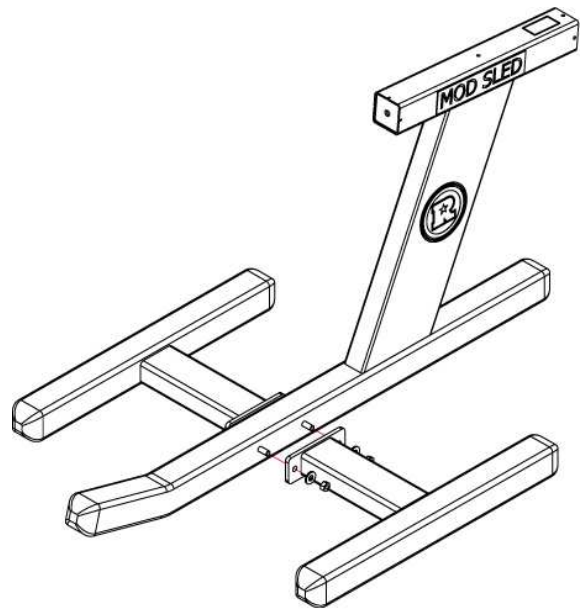
2

Fit second outrigger over the bolts and secure with (2) more 5/8" washers and (2) 5/8" nuts.

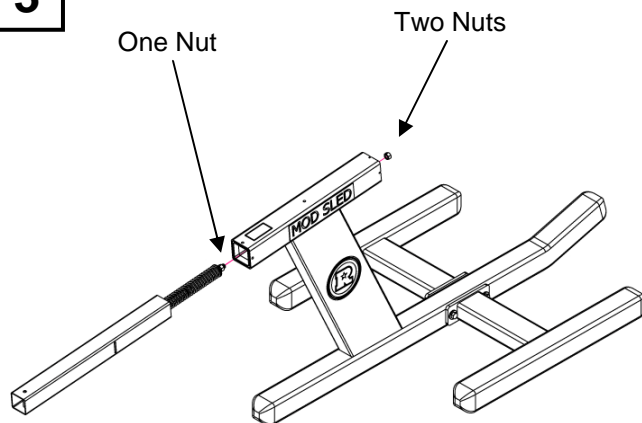
3

The Mod Ram Unit comes with (3) nuts on the threaded rod at the end of the spring. Remove (2) nuts to use later. Install the Mod Ram Unit by inserting it spring side first into the Ram Outer Tube. The threaded rod on the end of the spring fits through a hole at the back of the head unit. A screwdriver can be used to guide the threaded rod through the hole. Use the nuts you removed earlier to secure the ram in place.

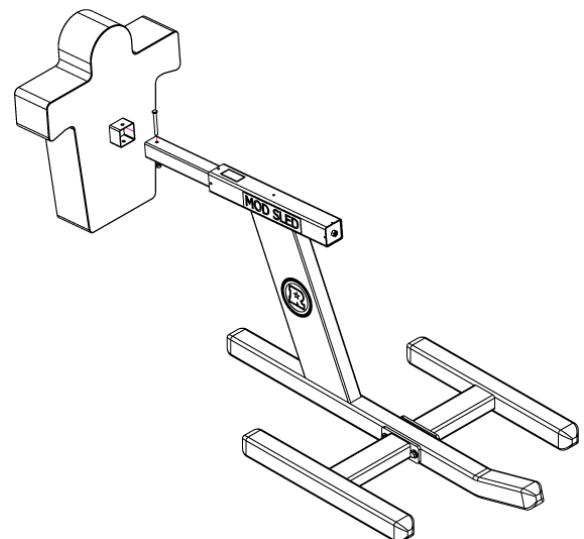
4

Use a fas-pin to fasten pad to the ram unit.

5

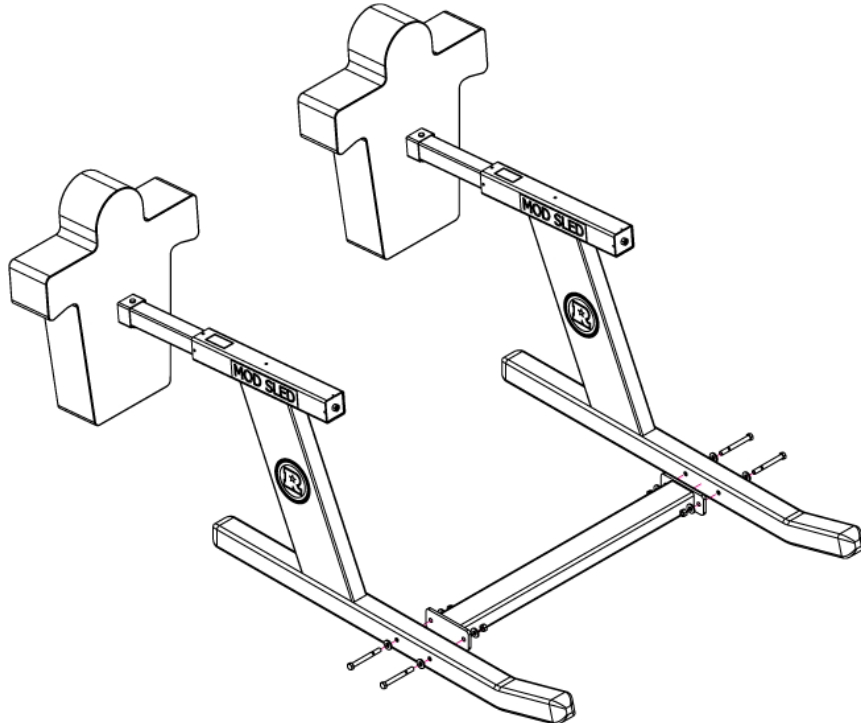

For 2-7 man Lev Sleds: See steps 3 & 4 for Ram Unit and Pad installation. To begin assembly lay Mod Sled runner on its side. Connect the runner to the connection link and then stand runner upright to connect the next sled runner. Hardware used for the Connection Links is (4) 5/8" x 6" bolts, (4) 5/8" nuts, and (8) 5/8" washers per Mod Sled Runner.

ATTACHING YOUR WHEEL KIT

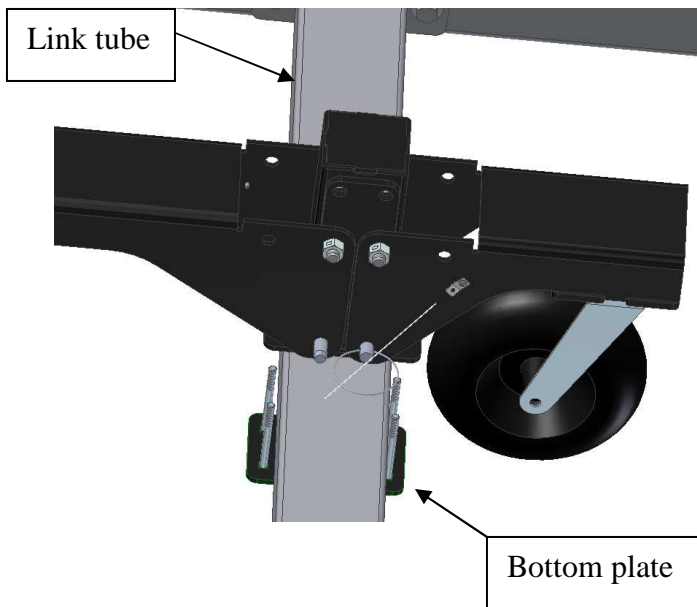

Attach wheel kit to center of link tube
Insert 4 bolts into holes on bottom plate
then put them through top plate and
tighten on 4 5/8 nuts

**Longer side goes on same side where
pads attach**

Use 2 kits for 2 or 3-man sleds, 3 kits for 4-man, 4 kits for 5-man, 5 kits for 6-man, 6 kits for 7-man.

USING YOUR WHEEL KIT

To raise wheel kit remove pin from lower hole and rise when wheel kit is fully raised insert pin in upper hole

To lower wheel kit remove pin from upper hole and lower when wheel kit is fully lowered insert pin in to lower hole

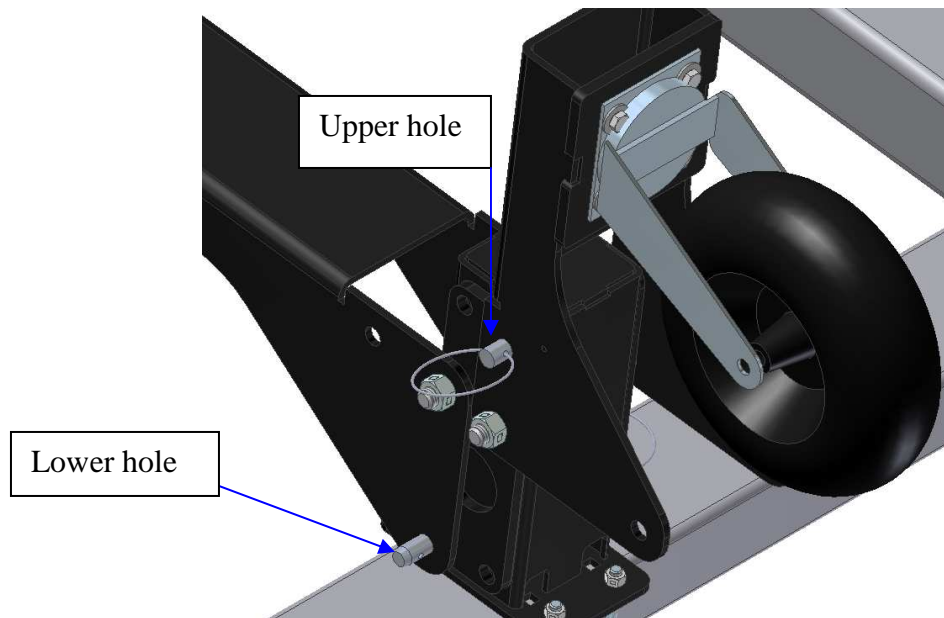

ATTACHING YOUR STAINLESS STEEL SKINS

Un-attach runner from link tube then slide stainless steel skin over bottom of runner and line up center holes that link tube attaches to. Reattach link tube and tighten down.

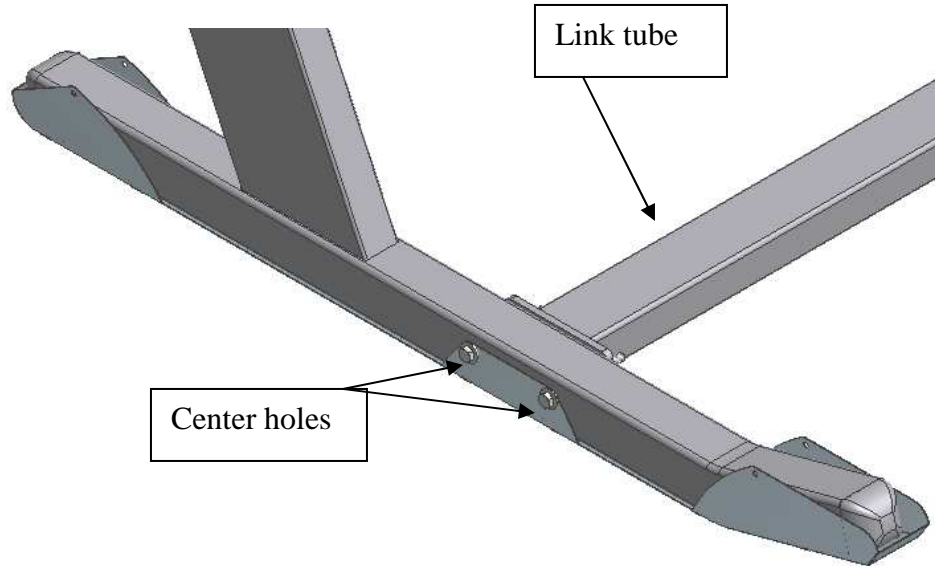

Place link tube connector between stainless steel skin and loosely screw in screws to link tube connector. After both sides are loosely attached tighten down both sides tightly. Repeat step to attach other link tube connector.

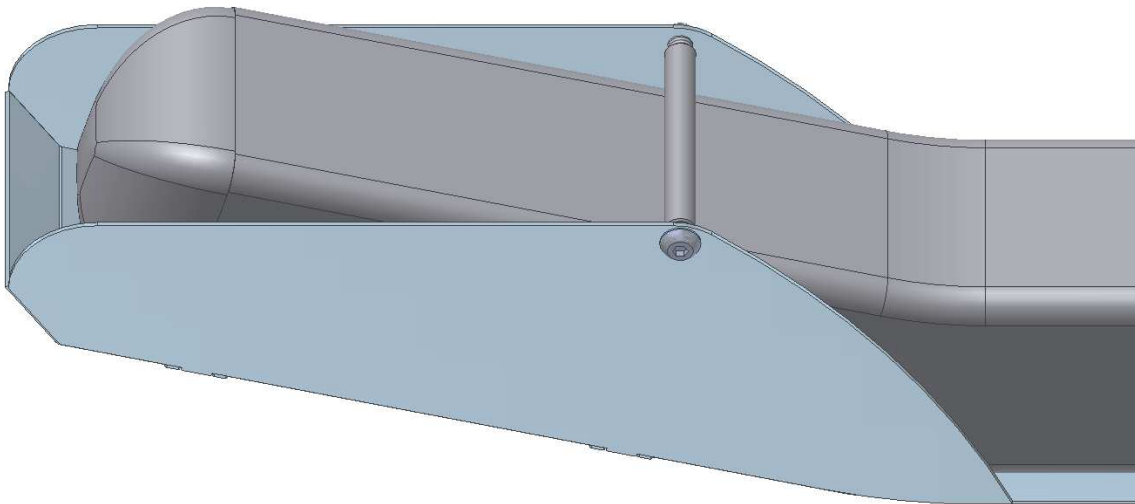

Note: Repeat steps for all runners

MAINTENANCE



WARNING!

READ AND UNDERSTAND ALL MAINTENANCE PROCEDURES.

Failure to follow all procedures listed below may cause serious injury and/or a decrease in equipment functionality.

- **Frequently check to see that all bolts are securely fastened.**
- **Touch up paint may be used to cover scratches or blemishes sustained through use.**
- **Field equipment should be washed periodically with soapy water to maintain original surface finish.**
- **A silicone based lubricant may be used on moving parts to maintain proper function.**
- **Replace any damaged equipment with genuine Rogers Athletic parts.** Failure to do so may result in unsafe equipment and/or personal injury.
- **Remove pads when not in use.** Store pads in safe dry place.

CUSTOMER SERVICE

For parts or service contact Rogers Athletic Company. When ordering parts be sure to provide all relevant information available including the name and part number of the equipment purchased. This information is located on the cover of this product information package. Customer service hours are Monday through Friday from 8:00 a.m. to 5:00 p.m. Eastern Standard Time. Customers can phone (989) 386-2950 or toll free at (800) 457-5337. Fax toll free at (888) 549-9659 or mail to:

Rogers Athletic Company
3760 W. Ludington Drive
Farwell, MI 48622