



-- BBFP-30SM --

-- SBFP-30SM --

(30' PROFESSIONAL / SOFTBALL FOUL POLE)



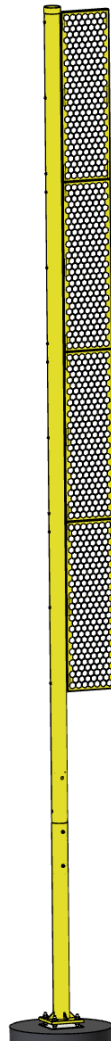





Installation Instructions

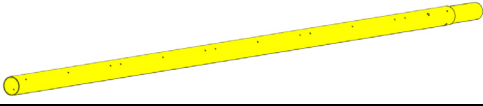
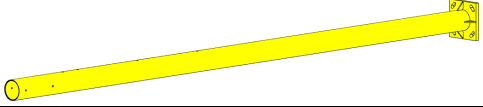
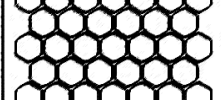



Call Jaypro Sports Equipment at 1-800-243-0533 during regular business hours for technical support.

www.jaypro.com

30' Professional / Soft Ball Foul Pole, BBFP-30SM / SBFP-30SM
QUANTITY IS FOR ONE COMPLETE FOUL POLE

ITEM	QTY	IMAGE	DESCRIPTION
1	1		TOP POLE <i>P/N: BBFP-30TU</i>
2	1		BOTTOM POLE <i>P/N: BBFP-30-D2</i>
3	4		PANEL <i>P/N: BBPS-B</i>
4	12		3/8" FLAT WASHER <i>P/N: HW2047</i>
5	6		3/8"-16 NYLON LOCK NUT <i>P/N: HN265</i>
6	6		3/8"-16 x 1" LONG HEX HEAD <i>P/N: HS286</i>
7	36		7/16" FLAT WASHER <i>P/N: HW5042</i>
8	12		7/16"-14 NYLON LOCK NUT <i>P/N: HN5070</i>
9	12		7/16"-14 x 7" LONG HEX HEAD <i>P/N: HS5383</i>
10	2		1/2"-13 x 7" LONG HEX HEAD <i>P/N: HS5049</i>
11	4		1/2" FLAT WASHER <i>P/N: HW2044</i>
12	2		1/2"-13 NYLON LOCK NUT <i>P/N: HN2951</i>
ITEM	QTY	IMAGE	DESCRIPTION

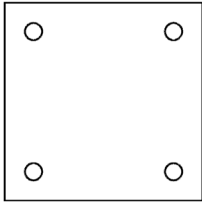
- Unpack all parts and check against parts list to ensure that all have been included.
- Inspect all parts for damage. Report any damages to the trucking company.

ITEM	QTY	IMAGE	DESCRIPTION
13	4		7/8"-9 x 18" LONG THREADED ROD P/N: SR5071
14	1		LEVELING PLATE P/N: FBGP-600-5
15	16		7/8"-9 HEX NUT P/N: P/N: HN5020
16	8		7/8"-9 FLAT WASHER P/N: HW5003
17	1		TOP CAP FOR 5-9/16" OD P/N: EC0050
18	1	 AVAILABLE IN:  YELLOW  WHITE  ORANGE	AEROSOL YELLOW RAL 1018 SINGLE CAN P/N: PT0062SC AEROSOL ORANGE RAL 2004 SINGLE CAN P/N: PT0101SC AEROSOL WHITE RAL 9003 SINGLE CAN P/N: PT0102SC
ITEM	QTY	IMAGE	DESCRIPTION

- Unpack all parts and check against parts list to ensure that all have been included.
- Inspect all parts for damage. Report any damages to the trucking company.

IMPORTANT NOTICE:

- 1) BEFORE EACH USE CHECK EQUIPMENT FOR PROPER CONNECTING HARDWARE AND STRUCTURAL INTEGRITY. REPLACE DAMAGED OR MISSING HARDWARE IMMEDIATELY.
- 2) USE OF THIS EQUIPMENT OTHER THAN INTENDED, MAY BE HAZARDOUS.
- 3) ALTERATION OR MODIFICATION OF THIS EQUIPMENT MAY BE HAZARDOUS AND RESULT IN INJURY. FOR REPAIR OR REPLACEMENT, CONTACT YOUR DEALER OR JAYPRO SPORTS.
- 4) CONCRETE SHOULD BE A MINIMUM 4000-PSI MIX.

ASSEMBLY INSTRUCTIONS

TOOLS / MATERIALS REQUIRED:

- (6) 3/4" x 66" Long Re-Bar (*NOT INCLUDED - Consult with local building code*)
- (1) 1-1/2" , 9/16" , 5/8" Socket Wrench and Box Wrench
- (1) Rubber Mallet
- (1) Lifting Device (*i.e. Crane*)
- (1) Concrete (4000 psi mix)
- (1) Leveling Device

- Unpack all parts and check against parts list to ensure that all have been included.
- Inspect all parts for damage. Report any damages to the trucking company.

Site Prep:

- 1) Determine the proper location of foul poles as shown in figure 1 & 2 on the playing field that is clear of debris or obstruction. Dig the footing holes to the dimensions as shown on the illustration on the next page. **These are suggested dimensions for average soil conditions, consult local building codes. Dimensions may need to be adjusted in areas subject to high wind loads.**
- 2) Assemble threaded rod to leveling plate by installing 7/8"-9 hex nuts onto threaded rod 11" apart and engaging about 5" of thread. Install 7/8"-9 hex nut onto threaded rod and tighten down so that the leveling plate is now held securely between the two nuts until the concrete done curing.
- 3) Pour the footing as shown in figure 2, using minimum 4,000 psi mix.
- 4) Place the assembled thread rod & leveling plate in the concrete, level and square.
- 5) Let the foundation cure for a minimum of 96 hrs.

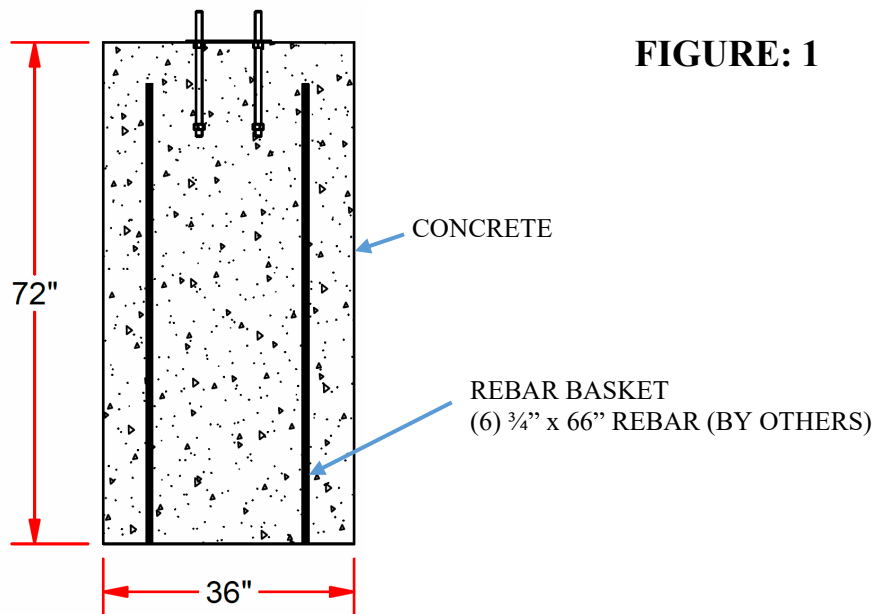
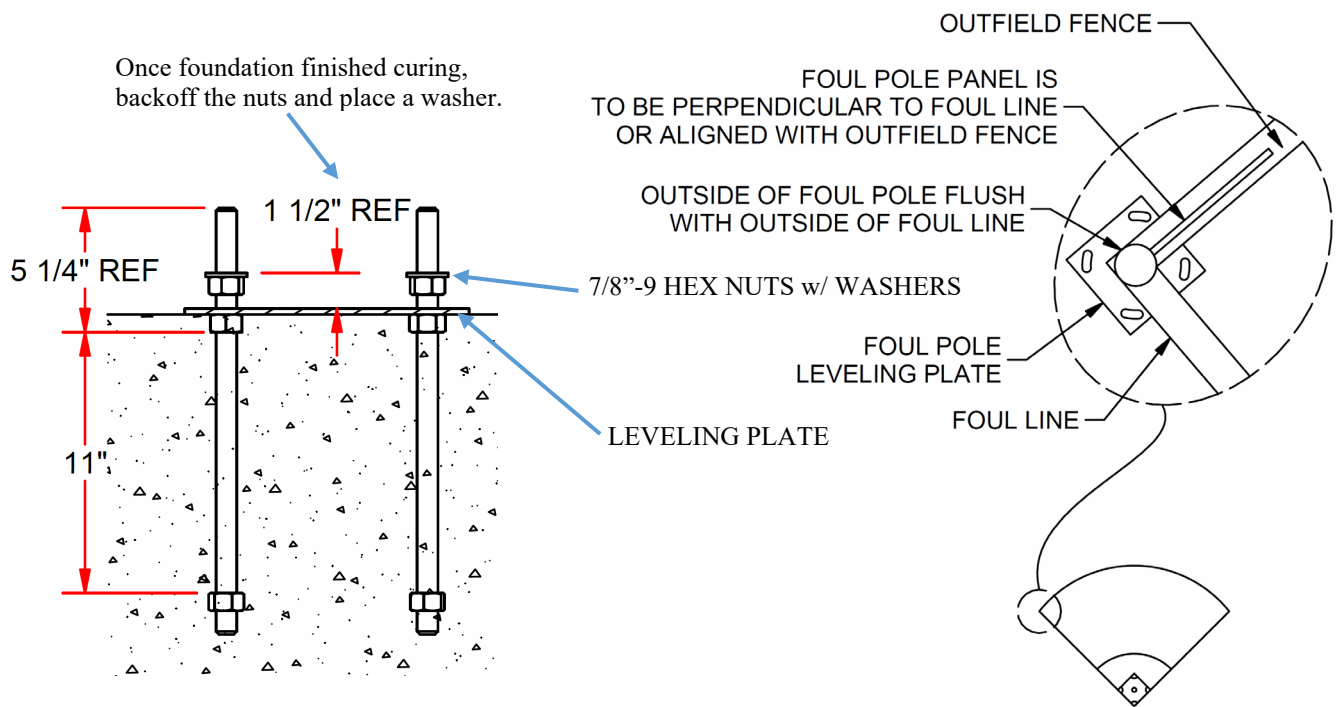

Note: These are suggested dimensions for average soil conditions, consult local building codes.

*For Areas Subject To Higher Wind Loads Footing Dimensions May Need To Be Adjusted.
See wind loading spec sheet.

Bottom Pole Section:

1. Lower the bottom pole over the threaded rods into the jellybean slots.
2. Adjust the bottom nuts up or down to plumb the bottom pole.
3. Rotate the upright as needed to align the panel mounting holes per the figure 1.
4. Secure the mounting plate with 7/8"-9 nuts & washers.

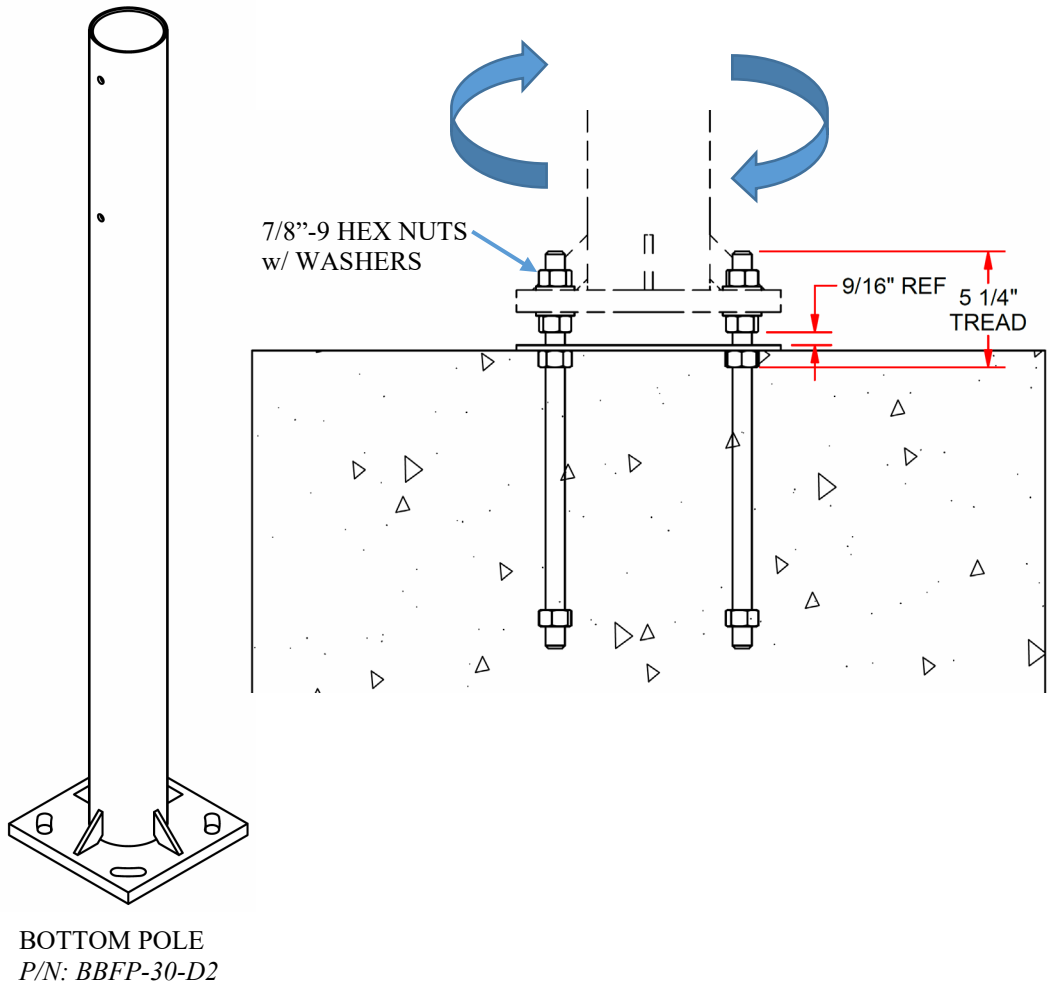

FIGURE: 3

Top Pole Section:

1. Install the top cap by tapping it on with a rubber mallet.
2. Insert the top pole into the bottom pole as shown below.

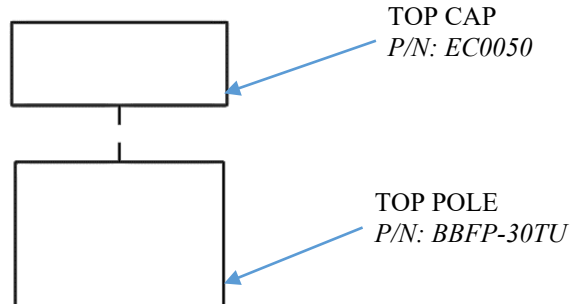
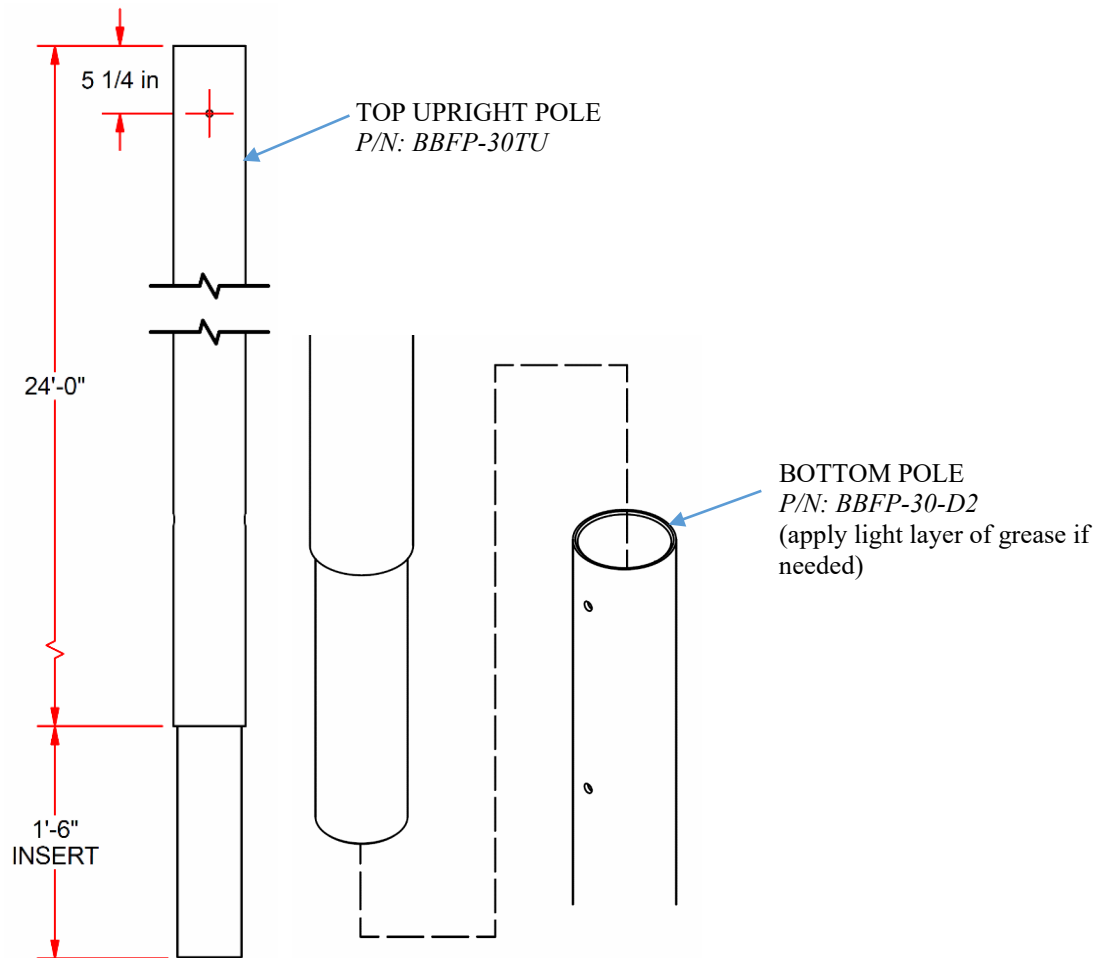

FIGURE: 4



Wing Panels:

1. Attach all the wing panels per figure 5. Orient the panels so the front side is facing the field. (Note image shown is from the back side of panels.)

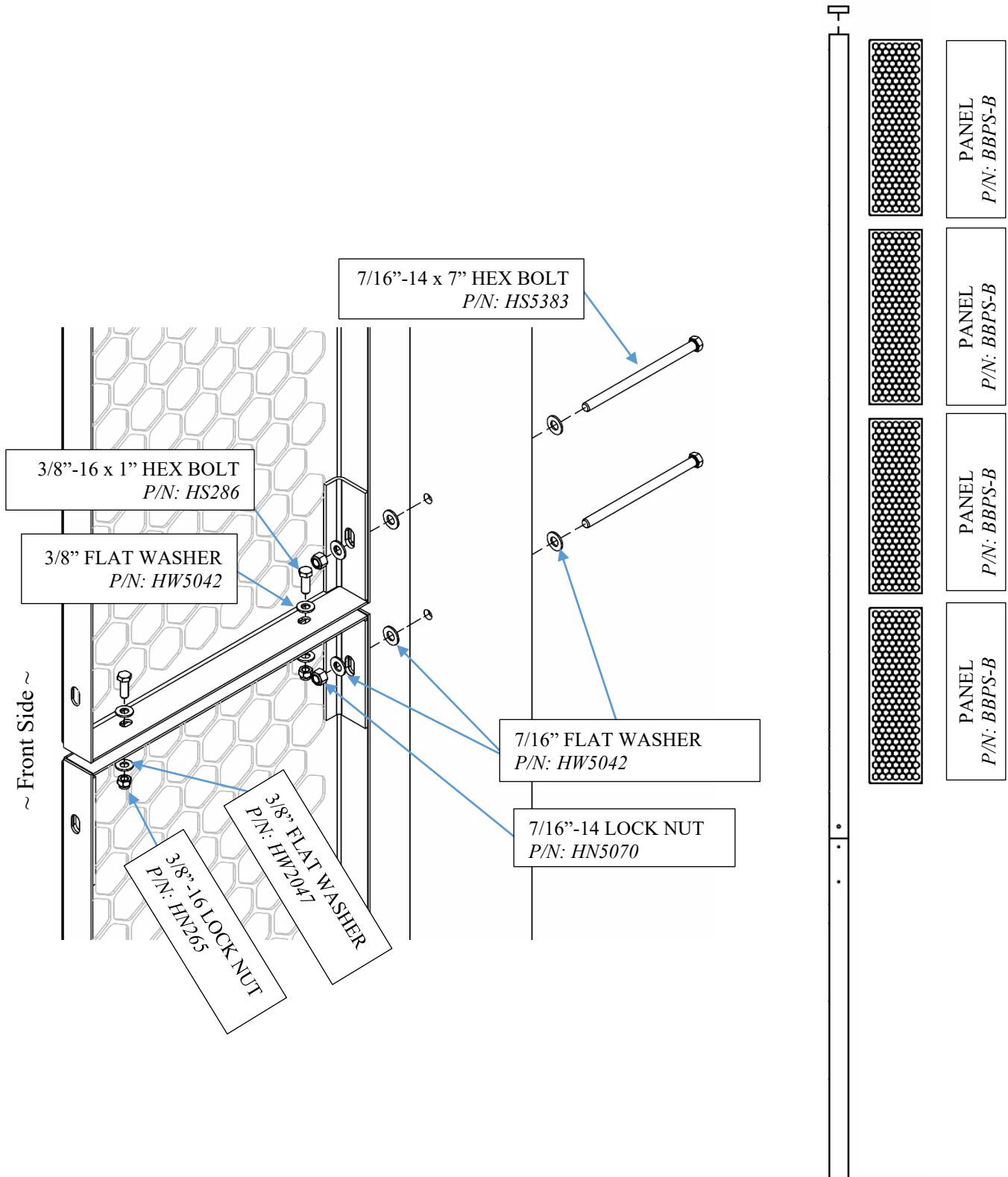

FIGURE: 5
(Backside of Panels Shown)

2. Rotate the pole to position the panels perpendicular to the foul line, as shown in figure 1.
3. Drill the two holes in the top upright pole to accommodate the hardware as shown. This finalizes the location. *Note drill holes for 1/2" hardware.*
4. Spray paint expose hardware to prevent rusting.

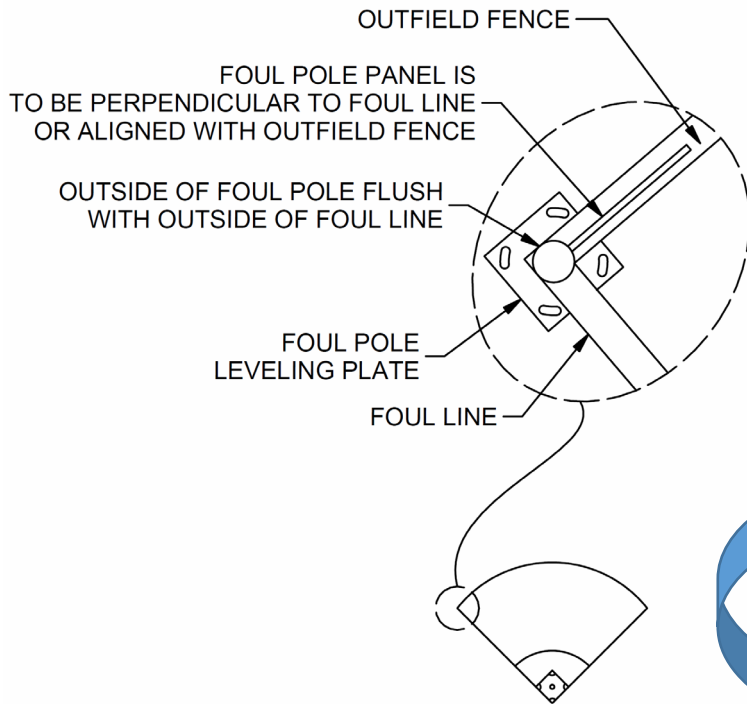

FIGURE: 1

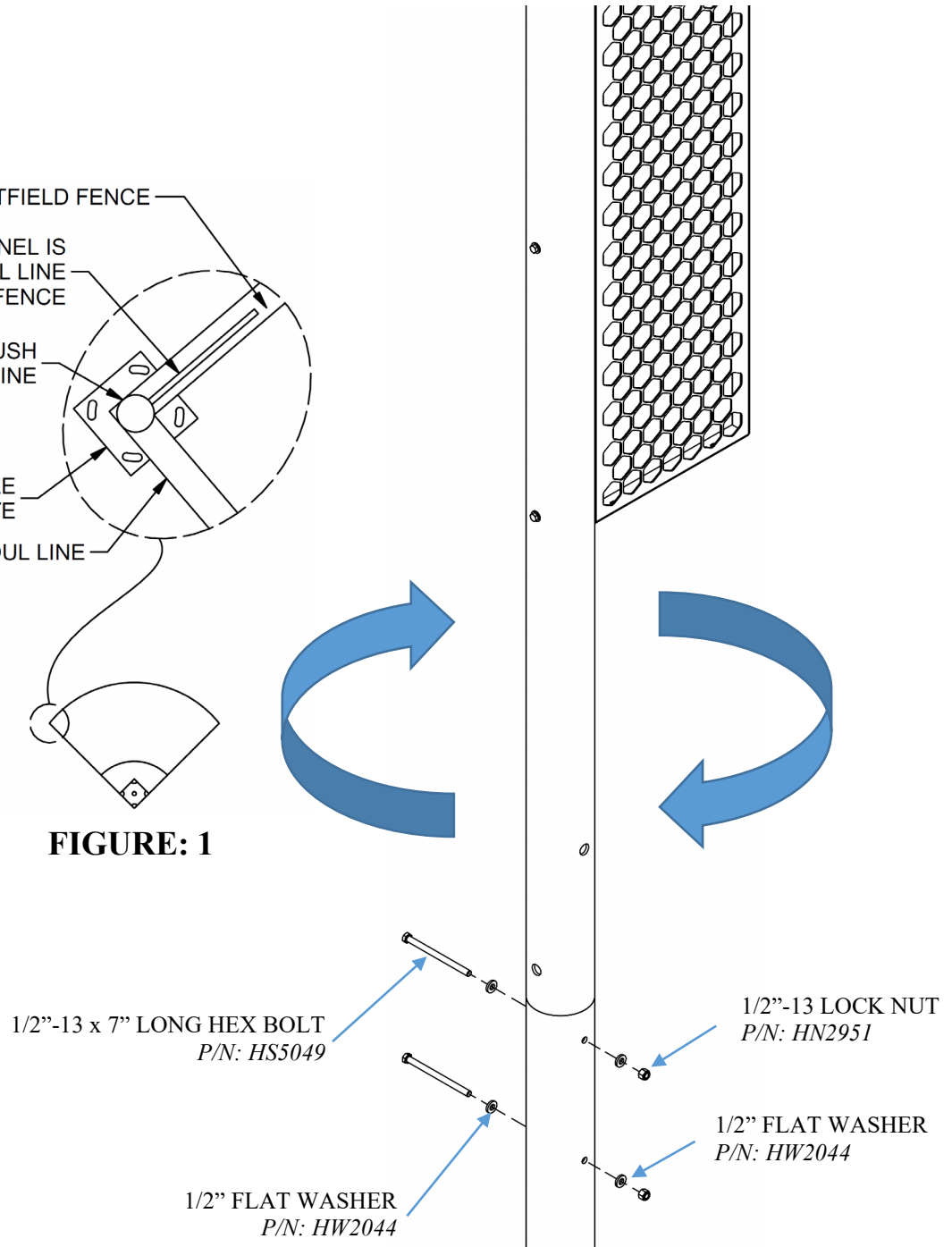

FIGURE: 6