

[www.gyrorboard.com](http://www.gyrorboard.com) [service@gyror.com](mailto:service@gyror.com)

 @gyrorboard

 @gyrorboard

 @gyrorboard

**GYROR<sup>®</sup>**

**K2<sup>≡</sup>**  
**HOVERBOARD KART**

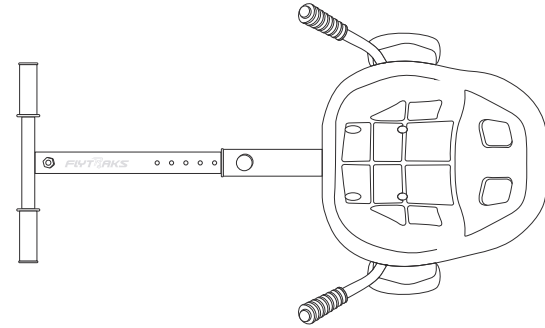

USER MANUAL

- This equipment is only for personal using. Don't use it for commercial purposes.
- Don't let children under 7 use it otherwise you do it at your own and your child risk.
- This is not suitable for elderly people and pregnant women.
- Don't ride after drinking or using drugs.
- Be familiar with local traffic regulations and comply with local laws. Have respect to pedestrians.
- Control you speed and pay attention to your all facts, which would influence your riding. Good visibility is very important. Don't exceed the speed limit and observe the weight limit to avoid an accident.
- In case of any accident, stay in place and wait for help.
- When you ride along with other users, keep safe distance between each other to avoid a collision.
- Other activities (such as: phone using, listening the music etc.) can distract your attention from riding. This is not recommended.
- Don't ride at slippery or wet roads and don't use it during the rain. Don't ride on uneven surface. Don't use it in snow or frozen area. Avoid dirt and small stones. Use it only on flat and clean surface.

## CONTACT

service@Flytraks.com  
support@Flytraks.com



## Contents

Contents .....	01
Prelude .....	02
LIMITS.....	03
COMPONENTS LIST.....	03
ASSEMBLY STEPS.....	04-06
SAFE USING.....	07
MAINTENANCE AND CLEANING.....	08
TERMS AND CONDITIONS OF WARRANTY AND CLAIMS.....	08
EXPLANATION OF SYMBOLS.....	09
SAFETY INSTRUCTIONS.....	09-10
CONTACT.....	10

## Prelude

Dear Customer

Thank you for purchasing Flytraks K2 Hoverboard Kart. Please read the user manual carefully before you start to use the product. Please note that items purchased from Flytraks are covered by one year warranty. During this period, all accessories can get a free replacement one time.

Your package should include:

1. Seat x 1
2. Handle x 2
3. Frame x 1
4. Front tube x 1
5. Wheel x 1
6. Flag x 1
7. Strap x 4
8. Instruction Manual
9. Install Tool

Any problem,  
Contact us with your order number  
Email: [service@Flytraks.com](mailto:service@Flytraks.com)/ [support@Flytraks.com](mailto:support@Flytraks.com)  
We look forward to serving for you

Kind Regards,  
Flytraks Team

## LIMITS

Respect these limits to use this product safely:

Max. speed limit: 12 km/h

Max. weight limit: 100 kg

## COMPONENTS LIST

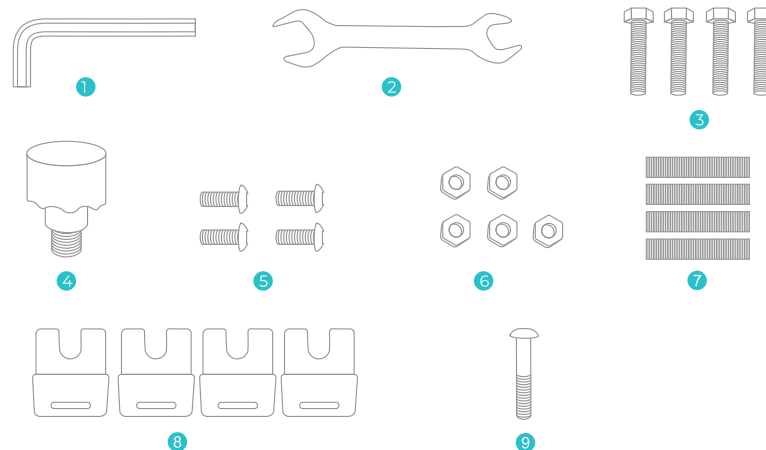

- 1 Allen key x 1
- 2 Allen wrench x 1
- 3 Allen screw M8\*50 mm x 4
- 4 Knob x 1
- 5 Allen Screw M8\*20 mm x 4
- 6 Anti-slip nut M8 x 5
- 7 Straps x 4
- 8 Anti-slip protect cover x 4
- 9 Allen screw M8\*40 mm x 1

**NOTE: If the kart accessories are missing or damaged, please feel free to contact us**

**Email:** [service@Flytraks.com](mailto:service@Flytraks.com)/[support@Flytraks.com](mailto:support@Flytraks.com)

## ASSEMBLY STEPS

Follow these steps to assemble it correctly:

**Step 1:** Open the box and check if there is no missing parts.

**Step 2:** Front tube: put the tube into it and adjust the suitable hole. Use the Knob (COMPONENTS 4) to fit in suitable length.



**Step 3:** Handles: Use Allen wrench (COMPONENTS 2) and Allen key (1) to assemble handles with four Allen screws M8\*50MM (COMPONENTS 3) and four Anti-slip nuts M8 (COMPONENTS 6). Make sure that you have attached the handles correctly before next step.



**Step 4:** Shock absorber: Use Allen key (COMPONENTS 1) to fasten the shock absorber to the transverse support with two Allen screws M8\*40MM (COMPONENTS 7).



**Step 5:** Seat: Use Allen key (COMPONENTS 1) to fasten the seat to the transverse support with four Allen screws M8\*20MM (COMPONENTS 5).



**Step 6:** Attach the complete assembly to a board and adjust the nut on the end of the transverse support, so that it fit the board size. Fasten this assembly to the board with the belts. Check if the belts are firmly tightened before each using.



**Step 7:** Flag: Use Allen key (COMPONENTS 1) to fasten the flag holder to the transverse support with one Allen screws M8\*40MM (COMPONENTS 7), then connect the flagpole and plug in the flag.



**WARNING:**

- Don't let this device work without any person sitting on. It could be dangerous.
- If you want to detach this device from the board, loose the belts.

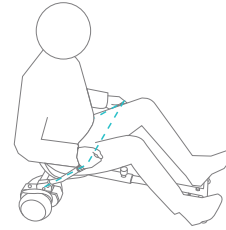

**Horizontal stop**

Keep both handles horizontal.

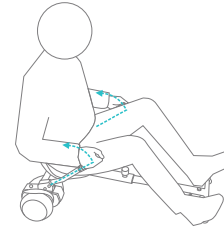

**Backwards**

Lift up both handles.

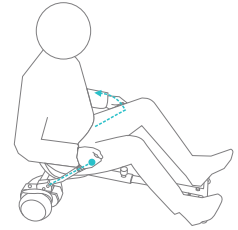

**Turn right**

Put down the left handle.  
Do not move your right handle.

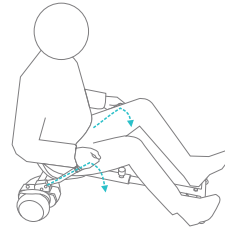

**Forward**

Push both handles down.

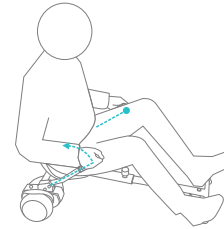

**Turn left**

Put down the right handle.  
Do not move your left handle.

**SAFE USING**

- Before each riding:
- 1.Sit on the seat.
  - 2.Keep handles horizontally.
  - 3.Turn on the power switch.

## MAINTENANCE AND CLEANING

Regular maintenance and cleaning can increase the product life.

- Check all parts, wheels and bearings for wear.
- Replace damaged or worn parts immediately.
- Don't use a lot of water to wash it. Metal parts could go rusty.
- Use only little soapy water (cold or lukewarm).
- Use a duster cloth to clean it.
- Don't use any chemical cleaners.

## TERMS AND CONDITIONS OF WARRANTY AND CLAIMS

1. The K2 brand device is free from design and material defects that could affect its functionality, provided that the instruction manual provided at the conclusion of the contract was followed.

2. The warranty covers only the territory of United States, and the warranty period for K2 devices is 12 months, counting from the date of sale of the equipment, however, not longer than 15 months from the date of production placed on the product. Product warranty is 12 months from the date of sale of the equipment.

3. Defects revealed during the guarantee period will be removed free of charge within the shortest possible time, not exceeding 21 business days from the device being physically accepted to the site. If it is necessary to bring spare parts from abroad, the deadline may be extended by another 30 days.

4. This warranty does not cover damage resulting from the fault of the customer, in addition, the guarantor is not liable for damages and losses resulting from the use of the device being repaired

5. By the provisions of this warranty, further-reaching claims for damages are excluded, unless they result from the mandatory provisions of law. This text is only a brief description of the terms of the warranty. Full warranty terms and information can be found at [gyroorboard.com](http://gyroorboard.com)

## EXPLANATION OF SYMBOLS

This symbol means that the product must not be disposed of the combination of waste electrical and electronic equipment together with other waste. You can prevent potential negative effects on the environment and human health that could arise from inappropriate handling of waste from used electronic equipment if the product is disposed of properly.

The symbol means that the packaging contains an instruction manual that must be read before use.

## SAFETY INSTRUCTIONS

- Read this manual carefully before use and keep it for future reference.
- Checking if all components, like screws and nuts fit well. Check wheels and bearings before use.
- Pay attention to speed limits.
- Don't expose yourself or others to danger while riding. Don't ride on steep slopes or on uneven surface.
- Use it only according to attached manual. Don't do any improper adjustment or maintenance. This could decrease safety of this equipment.
- Incorrect using can cause serious injuries.
- Check this equipment regularly and be aware that worn or used parts must be replaced immediately.
- Do not use if you notice any damage at the product.
- Do not use it if you find any sharp edges at the product.
- Train and gain experience before first riding. Try to learn how to use it properly before first ride. If you are not sure, ask someone for help or advice.
- Pay attention using this equipment on public roads or sidewalks if it is allowed to use. Make sure that you don't violate local laws or prescriptions. If you are not sure, ask local authorities.
- Don't use it at public roads (including motorways).
- Only one person can use it at the same time. Don't use it for transportation of other people.
- Don't carry items while riding.
- Never use it in darkness or at night time. Don't use it in worsened visibility conditions.
- Wear protectors (elbow, knee, wrist etc.) and helmet before each riding.