

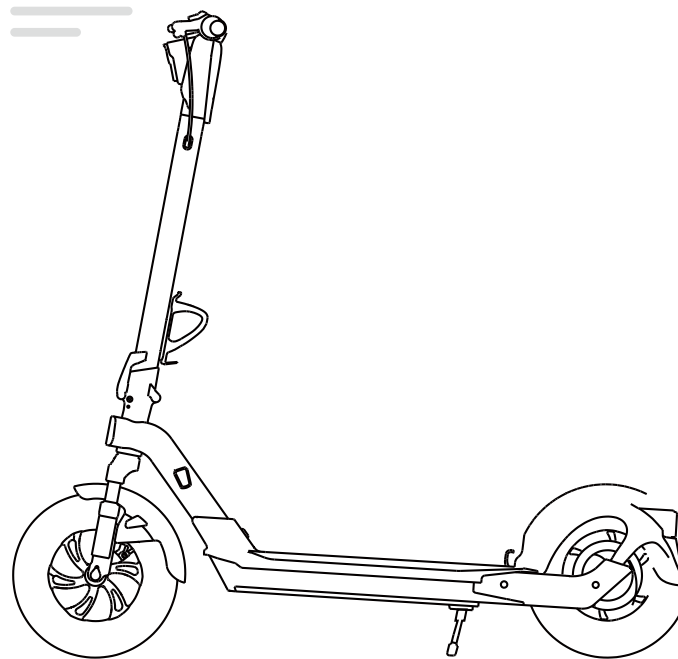

Scan GYROOR Instagram QR code to get more information.

The manufacturer reserves the right to make changes to the product, and updates this manual at any time.
Visit www.gyror.com to download the latest user manual.

www.gyror.com



**Scan GYROOR Instagram QR code
to more informations.**

GYROOR[®]

User Manual

X3 Electric Scooter

Email: help@gyror.com

[f @Gyror](#) | [@gyrorboard_official](#) | [@gyror](#)

www.gyror.com

Any questions, please get in touch with us at

Email: help@gyroor.com



@Gyroor



@gyroorboard_official



@gyroorboard



Scan GYROOR Instagram QR code to get more information.

The manufacturer reserves the right to make changes to the product, and updates this manual at any time.
Visit www.gyroor.com to download the latest user manual.

www.gyroor.com

USER MANUAL

There are important instructions on safety and usage in the User Manual. You must read it entirely and carefully before your first ride.

1. Please record the unique serial number of the scooter. You can find the serial number from the app and from the label of the scooter.
2. Please keep the original package one month at least.
3. Please charge once a month when not in use.
4. Please contact us directly if you need any help or experience any problems.
5. Our after-sales support email is: help@gyroor.com

Contents

1: Configuration	03
2: Packing List	04
3: Assembling the Device	05
4: How to Operate	08
5: APP Control	09
6: Cruise Mode & Zero Start	11
7: Removable Battery	11
8: Two Charging Methods	12
9: Beginners	14
10: Avoid Potential Safety Hazards	16
11: Please Do Not Do	18
12: How to Fold	20
13: Safety Instructions	21
14: Daily Maintenance	23
15: Model Parameter Table	24
16: Guaranteed Warranty	25
17: Contact US	26

1 Configuration

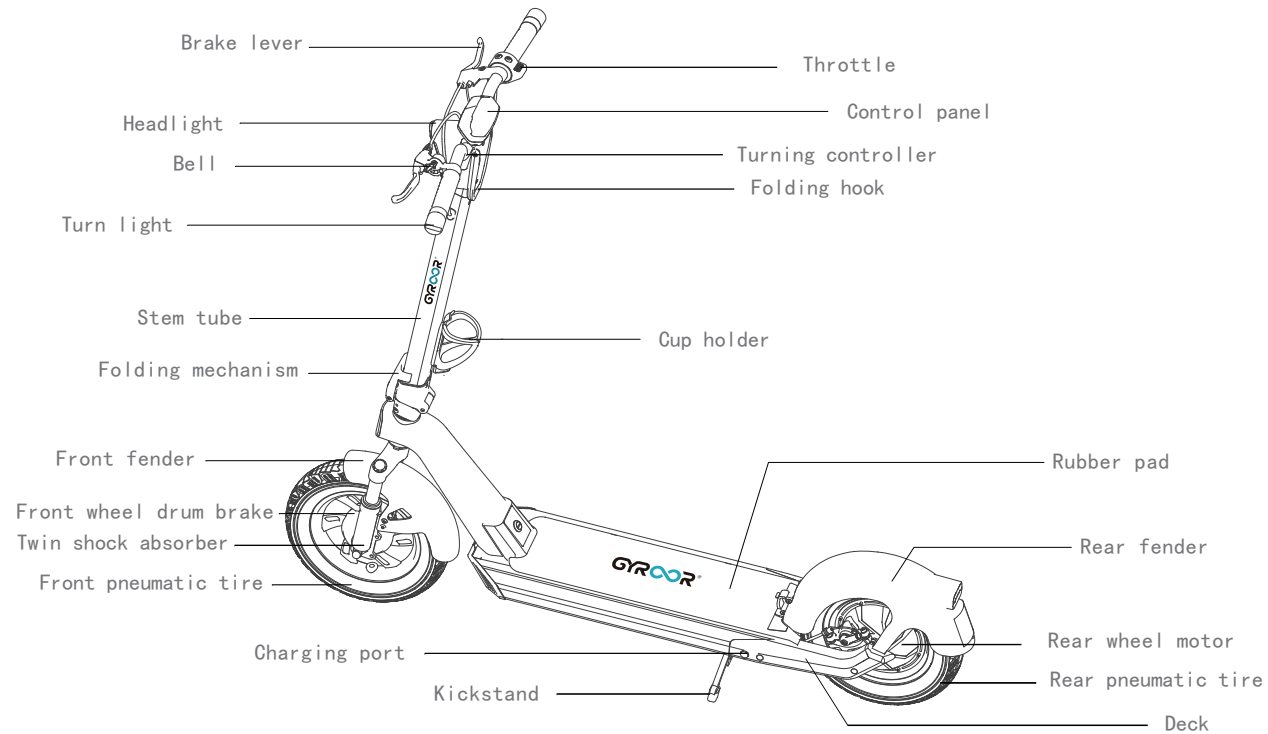

2 Packing List

X3 electric scooter package includes the following parts in the box. Please check it after unboxing. **And we recommend keeping the original packaging for 30 days at least.**

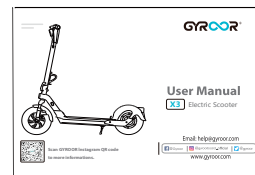
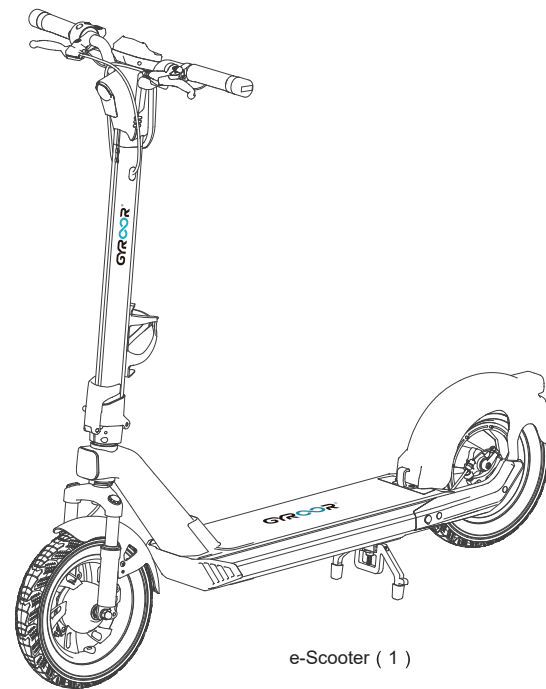

User Manual (1)



Replaceable Inner Tube (2)



Hexagon Wrench(3mm, 5mm)

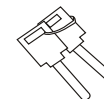

Key for battery(1)



Charger (1)

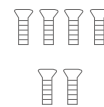

Screws(4+2 replacement)

e-Scooter (1)

Any lack or loss, please do not feel hesitate to contact our email at help@gyroor.com

3 Assembling the Device

1. Install the fender



(1) Unscrew the 4 screws of the front fork



(2) Straighten the fender head up, align the hole

2. Install the front wheel



(3) Tighten the 4 screws



(4) Take out the screws & fixing pieces on both sides



(5) Place the drum brake on the right side, align with the hole, and clamp down firmly



(6) Observe whether the front wheel is aligned



(7) Align the fixing piece with the hole and fix it



(8) Use tools to tighten the screws on both sides

3. Fixed brake line

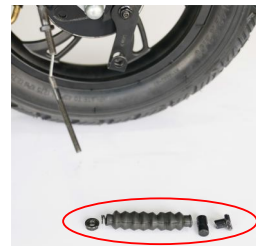

(9) Take out the parts in the order indicated in the picture



(10) Pass the brake cable through the gap and fix it



(11) Tighten the screw fixing the brake cable



(12) Route the brake cable through the spring and sleeve

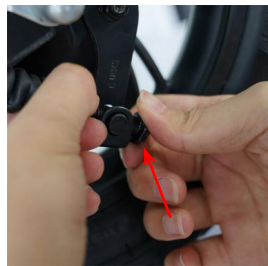

(13) Tighten the brake nut



(14) Adjust the tightness of the brake by adjusting the tightness of the nut

4. Install the head



(15) Find the grooves inside the control wires, align and connect them

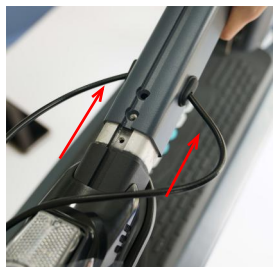

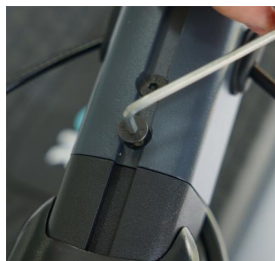

(16) Align the head with the steering rod and insert them

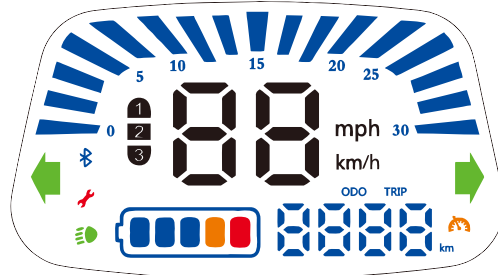

(17) Tighten the 4 screws

4 How to Operate



Power Button 	Press 2-3s	Turn on/off
	One click	Switch speed
	Double click	Switch speed unit
	Triple click	Cruise mode on/off
Light Button 	Four click	Zero start on/off
	One click	LED lighting on/off
	Double click	Switch TRIP/ODO
	Press left/right	Left/right turn signals

1: Mode Selection: 3 driving modes are available, which respectively are Limited speed is 12 mph; Limited speed is 16 mph, and

Limited speed is 20 mph; Single click to switch the mode.

2: Speedometer: Indicates the current speed. Also displays error codes when faults are detected.

3: Bluetooth: A solid Bluetooth icon indicates that the vehicle is connected to a mobile device. You can view the vehicle status after connecting to the APP via Bluetooth.

4: Over-temperature Display: If the internal temperature of the controller and motor is too high during the operation of the vehicle, the panel will promptly display an over-temperature alarm.

5: Failure Alarm: When the controller fails, the alarm symbol will light up to warn.

6: Power display: when the power is more than 85%, the display is full, and it will gradually go out as the power drops.

5 APP Control

1.Download GYROOR app

Please search GYROOR from APPLE App Store or GOOGLE Play,download GYROOR app to your smart phone.
Or you can download GYROOR app by scan the QR cord.

Open the GYROOR app, and choose the checkbox "Read and agree on Privacy Policy".

2.Register an account

Open the GYROOR app,click "my" button on the bottom right corner,then click "register" button.Use your email and other informations to register an account.Please remember choose your country and choose the checkbox "Read and agree Privacy Policy". Finally,click the "REGISTER" button.You will receive a validation letter in your register email.Please click the validation letter,it will jumps to the web gyroorboard.com automatically.You will see "Your email address is verified",it means register successfully.

3.Pair with Gyroor X3 scooter

- (1)Open your smart phone bluetooth(Click the settings button on the right side of the main page to switch languages)
- (2>Login in your GYROOR app account.
- (3)Power on your Gyroor X3 electric scooter.Cell phone and scooter must be within 10 meters of each other.
- (4)Click the left bottom button on your GYROOR app home page.
- (5)Slide product thumbnails or check from the pull-down list to choose the Gyroor X3 electric scooter.
- (6)Click the "connecting device" to pair with the scooter.

4.APP Functions

After pair with the scooter, you can operate the scooter with your GYROOR app.

1.About the main page

In the center of the page you can see the current speed and remaining battery power.

Bluetooth: connect/disconnect device.

Lock: open it and the scooter will be difficult to remove in case it gets wheeled away.

Light: turn on/turn off the head light.

Model: click it to choose between 1 mode (ECO), 2 mode (Slow), and 3 mode (Sports).

ECO mode,the limited speed is 12Mph;Slow mode,the limited speed is 16Mph;

Sports mode,the limited speed is 20Mph.

Cruise Control: click it to turn on, and the scooter will automatically turn on the cruise control system after maintaining the same speed for 6s. After this, you can press the throttle to release.

2. About the Setting page

Click it to enter into the subpage. In the subpage.the following functions are ready.

(1)Cruise control; (2)Riding mode; (3)Lighting control; (4)Atmosphere lamp; (5)Metric or Imperia;

(6)Boot mode; (7)Language; (8)Advanced settings; (9)Firmware update.

PS:Click"advanced settings", drag the progress bar to set "Accelerator Response" & "Brake Response", **and you can also adjust the speed limit.**

3. About the Details page

In the subpage.the following information are ready.

(1)Battery; (2)Speed; (3)Voltage; (4)Current; (5)Input power; (6)Motor Temp;

(7)Controller temperature; (8)Distance; (9)Total Mileage; (10)APP vrsion.



IOS QR Code



Android QR Code

6 Cruise Mode & Zero Start

1. Cruise Mode

When cruise mode is on, maintain the same speed for 6 seconds to enter cruise mode. Press the accelerator or brake to cancel the cruise mode.

If a triple click of the power button turns off the cruise mode, no matter how long the scooter maintains the same speed, the cruise function will not be turned on.

2. Zero Start

Generally speaking, the original setting of the scooter is a non-zero start mode, that is, you need to press the accelerator after pedalling and sliding the scooter for a certain distance, and then it will accelerate.

If you turn on the zero-start mode by pressing the power button 4 clicks, when the scooter is stationary, you can accelerate as long as you press the accelerator (please use the zero-start mode with caution, if you accidentally press the throttle, it will accelerate suddenly and be dangerous).

7 Removable Battery

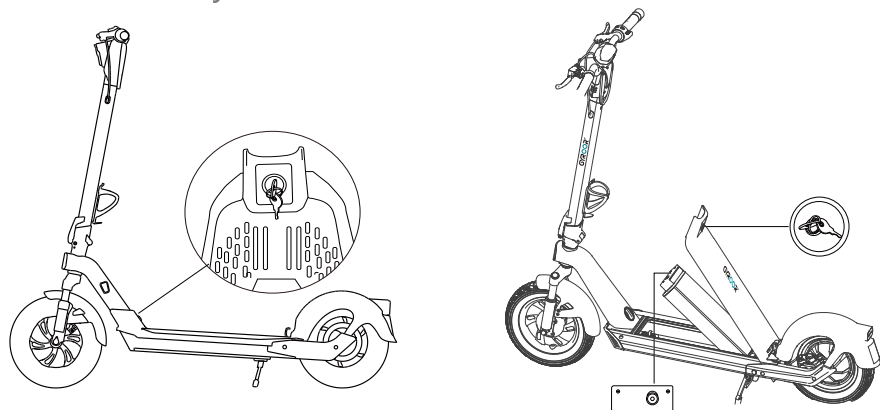

8 Two Charging Methods

For Scooter

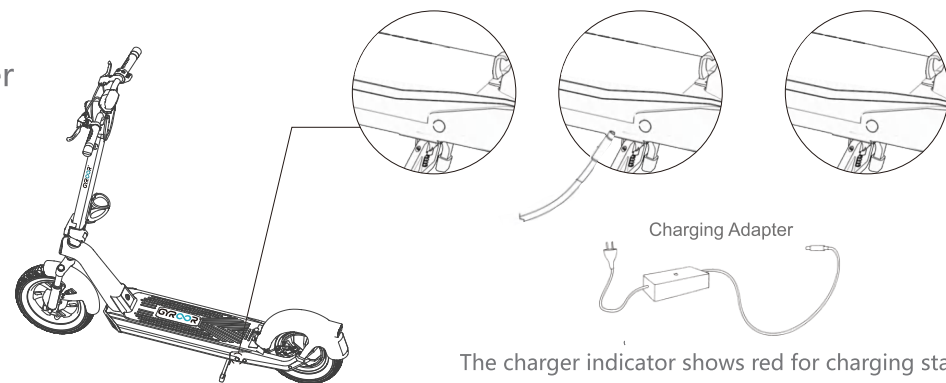

The charger indicator shows red for charging status and green for fully charged status.

For Battery

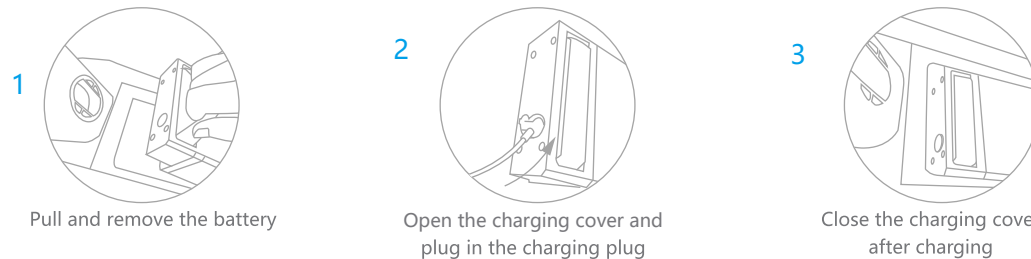

Safety Tips for Charging:

1. Before first use, please charge it at least 4-5 hours in proper temperature and environment;
2. In order to extend the battery life to the utmost, please charge it every month or two days after riding it;
3. The battery will be damaged without timely charging. As time goes by, battery capacity will gradually run out, which eventually leads to battery over-discharge;
4. Please use the batttery, charger and cable provided by original manufacturer, avoiding dangers caused by battery overcharge;
5. Please ensure correct connection of charger and cable in a well-ventilated environment;
6. Pleae use it under dry conditions. The charger or cable must not come into contact with water, for it may result in electric shock. No touching chager or cable with wet hands;
7. If there is any failure during charging, please pull plug off immediately;
8. Please make sure unplug from the plug end, not from the cable;
9. Please do not make the charger or cable come into with sharp or hot articles;
10. Please make regular check with the charger and its cable to avoid emergency;
11. If there is obviout damage of the charger or cable, please do not use the charger any more, and contact us for exchange.
12. Please do not repair the battery, charger or cable personally.
13. If there is any question during charging, please feel totally free to contact us at help@gyroor.com.

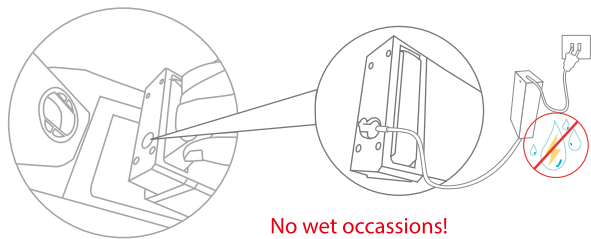

No wet occassions!



No wet hands!

9 Beginners

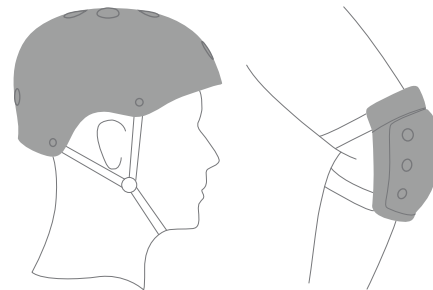

When you are learning, please wear helmets and protective gear during your riding.

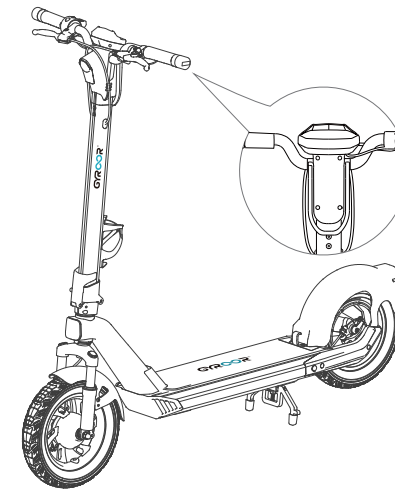

1 Power on the scooter and check the indicator lamp power level. Charge the scooter if the battery level is low.



2 After turning on and unlocking the scooter, stand on the footrest with one foot and push off with your other foot to start gliding.

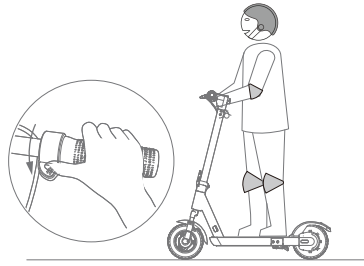

3 Put your other foot on the footrest to keep both feet stable. Press the throttle on right hand to speed up when you are balanced. Note, for your safety, the motor will not engage until the scooter reaches 5km/h

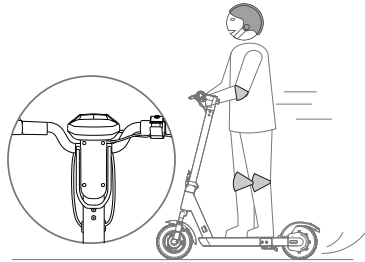

4 Slow down by releasing the throttle, hold the brake lever in order to make a brake, please note that the rear fender is not a mechanical braking and do not stamp it with foot while riding.

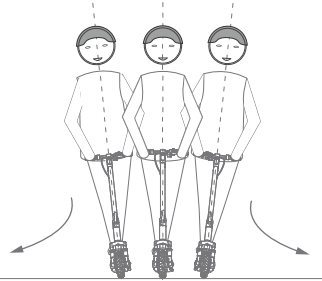

5 To turn, shift your body weight and turn the handle slightly.

10 Avoid Potential Safety Hazards



⚠ Do not Recommend Using when Raining or Freezing

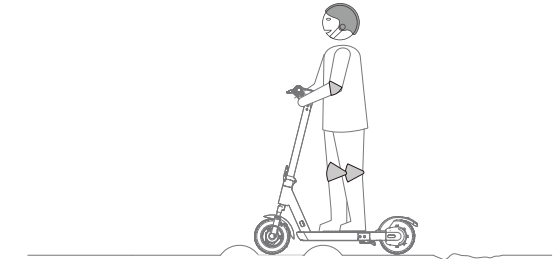

⚠ DO NOT ride over speed bumps, thresholds, or other bumps at HIGH SPEED.

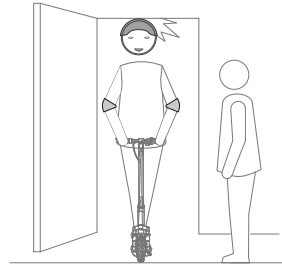

⚠ Watch your head when passing through doorways.

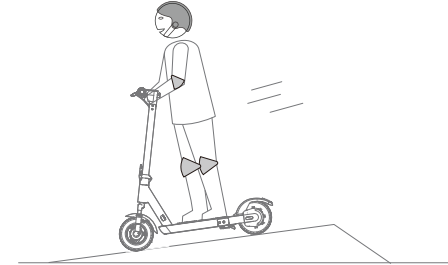

⚠ Watch your speed when traveling downhill.

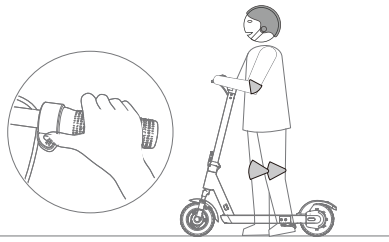

! DO NOT press the throttle when walking with the scooter.

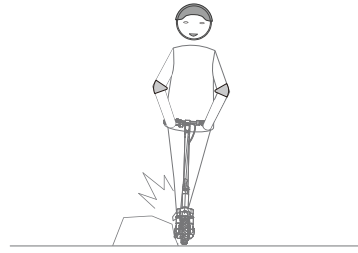

! Avoid contacting obstacles with the tire/wheel.

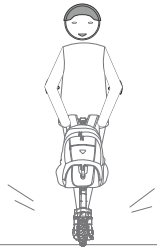

! DO NOT carry heavy objects on the handlebar.

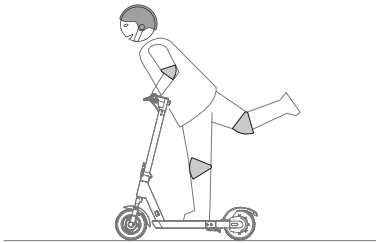

! DO NOT ride the scooter with only one foot.

11 Please Do Not Do

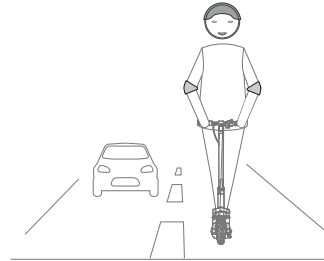

✗ DO NOT ride on public roads, motorways, or highways.

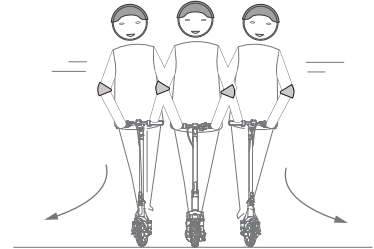

✗ DO NOT rotate the handle violently while driving at high speed.



✗ DO NOT ride the scooter in the rain or on the road with water in excess of 2cm depth.

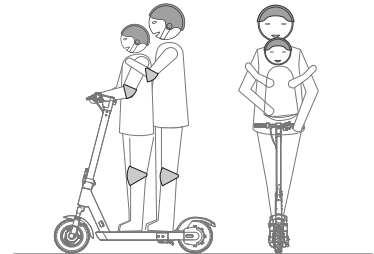

✗ The scooter is for one rider only. Do not ride double or carry any passengers. Do not carry a child.



⊗ DO NOT trample the rear end of the fender.

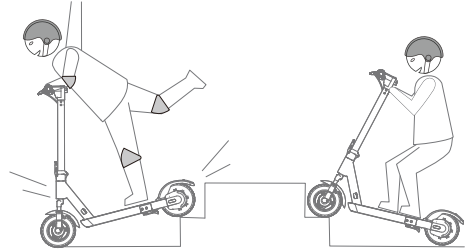

⊗ DO NOT ride up and down stairs or jump over obstacles.



⊗ DO NOT take your hands off the handlebar while riding. Do not ride with one hand only.

12 How to Fold

1

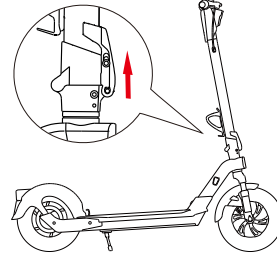

1. Turn off the scooter, pull up the safety button on the locking lever.

2

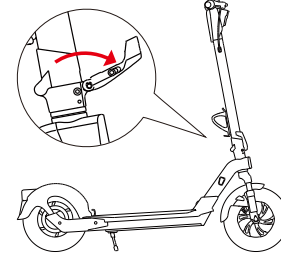

2. Pull the locking lever down to release the handlebar.

3

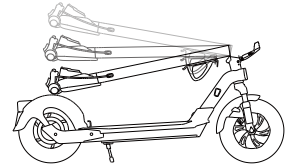

3. Carefully lower the handlebar centrally over the rear fender where it will lock in place.

Make sure scooter be off, hold the front pole, loosen a lock lever and lower a steering rack. Adding a steering rack in a horizontal position and secure it by inserting a hook through a special ring, which is located on the rear wheel mudguard. To Assemble the scooter, disconnect a steering rack lock from a hook of a mudguard, and then lift it into a vertical position and lock a lever.

13 Safety Instructions

Please understand that you can reduce the risk by following all the instructions and warnings in this manual, but you cannot eliminate all the risks. Remember that whenever you ride the vehicles you risk injury from loss of control, collisions, and falls.

The electric scooter is an intelligent and convenient transportation tool to meet the needs of short-distance. When entering into public spaces always comply with the local laws and regulations. For related laws and regulations, please consult the relevant local departments.

Note:

- ★Always wear helmets, gloves, elbow pads, knee pads and other safety protective equipment when riding;
- ★Check whether the power is sufficient and any abnormal noise or looseness before riding;
- ★Before riding, please gently press the brake handle to check the brake handle to confirm whether the brake function is normal and ensure the safety of riding;
- ★Ride on slippery roads is forbidden, especially on icy and snowy roads;
- ★Recommend not to ride on up and down slopes exceeding 15°;
- ★Ride on rainy days is forbidden;
- ★Not recommended for children under 15 years of age to learn and ride;
- ★Avoid sudden acceleration and deceleration, do not lean forward and lean backward too much, and prohibit speeding; when the power is insufficient, please keep riding at a low speed and charge as soon as possible;
- ★Focus on protecting personal safety when risk of falling and always adhere to the principle of "people are first";
- ★Do not put your hands in your pockets when riding to prevent unexpected situations;
- ★Do not leave the scooter in the trunk of the car for a long time in high temperature weather;
- ★Always comply with the local laws and regulations and keep a safe distance between you and other people or vehicles when riding.
- ★ Ride in a controlled condition at a speed that is safe for yourself and others around.
- ★Do not frighten people in public space, especially children; warn people and reduce speed when passing behind them ;

- ★Keep an appropriate safety distance with other riders, avoid danger and obstacles, and do not ride side by side unless there is enough space to pass through;
- ★Do not ride in the dark place, if necessary, reduce the speed and stay alert;
- ★Reverse riding is dangerous, try to avoid backward riding;

Active safety protection measures

Please read this manual carefully and understand and approve the contents.

- ★Do not let others use your scooter unless they have read this manual carefully;
- ★Please take good safety protection measures during driving. Whenever you ride, please wear an approved helmet with a hatband that can conform to the head shape and can protect the back of the head, and wear protective equipment such as gloves, eye protection equipment, elbow pads and knee pads;
- ★Do not ride if you are not well or cannot follow the instructions or warnings in this manual; do not ride under the influence of alcohol or drugs;
- ★Please get off the scooter and charge it in time to ensure safety when the scooter power is low, the alarm is continued and the speed is limited;
- ★Do not lift the scooter from the tire to avoid getting fingers stuck between the tire and the shell;
- ★Please check the scooter each time before riding. If any looseness or damage is found, do not ride before troubleshooting.

Please speed up slowly. Sudden acceleration can easily cause the scooter to lose its balance and cause the rider to fall and get injured! This is a dangerous habit and is responsible for most accidental falls and off-balance injuries.

Sudden dangers may occur during the ride, so ride carefully at all times. The company shall not be responsible for any personal injuries caused by failure to follow the instructions in the manual.

When charging an electric scooter, please choose an official charger and charge it in a safe, open and ventilated location designated by the community. It is forbidden to charge in an enclosed environment such as humid environment or family living room and bedroom containing flammable and explosive materials.

14 Daily Maintenance

If the surface of the scooter is stained, use a soft cloth dipped in a little water to wipe it; If it is difficult to clean, use the toothpaste and brush repeatedly the stain with the toothbrush, then clean it with the wet cloth.

Do not use alcohol, gasoline, kerosene, or other corrosive, volatile chemical solvents to clean, otherwise it will seriously damage the appearance and internal structure of the scooter. It is forbidden to spray and wash with a water torch. Ensure that the scooter is turned off during cleaning, and the charging cable has been unplugged and the rubber plug of the charging port is strictly tightened, otherwise it may cause electric shock or serious failure due to internal water ingress.

Place the scooter in a dry and cool place indoors, and avoid storing it outdoors for a long time. Exposure to the sun/over-heat/over-cold outdoors can accelerate the scooter appearance and tires of aging and reduce the life of the battery pack.

Maintenance of scooter battery pack

Do not put the battery pack in a high-temperature environment above 50°C or a low-temperature environment below -20°C (for example, do not put the scooter or its battery pack in a car exposed to summer exposure). It is forbidden to put the battery pack into a fire, otherwise it may cause the battery to fail, overheat, or even catch fire.

Avoid completely exhausting the battery before recharging, and try to use it as much as possible, which can greatly extend the life of the battery. In addition, the battery can play a higher cruising range when used at normal temperature; the battery life and performance will be reduced if it is used in an environment below 0°C. Typically, in the -20 °C environment, the cruising range may only be half or less than at room temperature. After the temperature rises, the battery range will be restored.

When the scooter is not used for a long time, it is recommended to charge the scooter battery every 0.5 to 1 month.

(Note: If the battery emits a strong smell or becomes hot, stop using the product immediately. Non-professionals are forbidden to disassemble the battery pack at will, otherwise it may cause serious safety accidents due to electric shock or short circuit!)

15 Model Parameter Table

Parameters	Item	X3
Dimension	Folding Size (mm)	1370*580*570
	Height(mm)	1270
Weight	Max load (kg)	120kg
	Net Weight(kg)	25kg
Riders	Recommended Age	16-50
	Required Height (cm)	120-200
Machine parameters	Max speed(km/h)	≤32
	Theoretical cruising (km)	60km
	Climbing Slope	25%
	Operating temperature	-10°C~40°C
	Waterproof level	IPX5
Battery pack parameters	Rated voltage(V)	36V
	Max charging voltage(V)	42V
	Battery capacity (Ah)	36V/15Ah
Motor parameters	Rated power(W)	500W
Charger Parameters	Rated Input Voltage (V)	100V~240 V/50HZ~60HZ
	Rated Output Voltage (V)	42V
	Rated current (A)	2A
	Charging time (h)	7h
Bluetooth	App	YES

Note: The data and parameters may vary with different models. No additional notice will be made in terms of any variation.

*Endurance: Tested under full power, with a load of 75kg, 25°C, and driving at a constant speed on the road at a speed of 15km/h. (The specific endurance depends on the weight and road conditions)

16 Guaranteed Warranty

We provide free maintenance, exchange and return services for products or spare parts that meet warranty conditions. In addition to insurance, postal & shipping costs, warranty service is free of charge.

During the warranty period, if the damage caused by personal improper use, the after-sales service center or designated maintenance site supports paid services.

All the customers will be covered by the warranty cards. The serial number(SN) code on warranty card must be the same as the one on vehicle body. The warranty start date is based on the date recorded on the purchase invoice and the earlier the product activation date.

If you can not show proof of warranty start date, use the manufacturer date as the warranty start date to calculate whether the product is still within the warranty period. After replacement, the product warranty period is recalculated. By our company stamping the back of the invoice, indicating the date of replacement, and providing a new warranty card.

Name		SN Code	
Purchase Date			
Phone Call			
Email			
Address			
Dealer Name		Phone Call	
Dealer Address			

17 Contact US

Any questions, please get in touch with us at

Email: help@gyroor.com



[@gyroorboard_official](#)



Scan GYROOR Instagram QR code to get more information.

The manufacturer reserves the right to make changes to the product, and updates this manual at any time.
Visit www.gyroor.com to download the latest user manual.

www.gyroor.com