

Mini Area Flood Lights

3 CCT Selectable: 30/40/50K



Available now in tri-color and custom color finishes, light up your outdoor area with the HTM Bolt Series; Area Light Mini fixtures with high lumen per watt efficacy combined with a stunning finish. The Mini BOLT series are available in a trunnion, 1/2" knuckle, straight arm and slip fitter mounting brackets. The HTM area flood lights are equipped with a diecast aluminum housing, finished with a matte bronze power paint (or custom finish), and anti-corrosion priming. Enjoy lighting up your outdoor area with over 115lm/w+ efficiency.

Detail Specifications:

- CRI 80 LED Chips
- 120-277V Driver, PF >0.9
- 15, 30 & 50W: Non-Dimmable
- 80W: 0-10V Dimmable
- Type 3 Beam Angle
- Operating Temp: -4°-114°F

Mounting:

- 1/2" knuckle option for all sizes
- Trunnion option for bronze finish
- Slip Fitter/ Straight Arm SFA option for 80W

Applications:

- Residential, Commercial, Industrial use
- General outdoor lighting
- Landscape lighting
- Pathways, streets, loading areas, etc

Product Information:

- CCT selectable
- Sturdy die-cast aluminum housing finished with corrosion free powder coat
- Suitable for wet location, IP65 rated
- 1.5' Power cable connected to every fixture
- L70 @ 70,000 Hours lumen maintenance

Certifications:

- ETL Listed for USA and CA
- DLC Listed
- IESNA LM-79 & LM-80 tests available
- FCC CFR 47, FCC Part 15, Subpart B:2017
- 5 Year HTM LED Limited Warranty

Included:

- LED Fixture
- Mounting Bracket

LED - ARL - Watts - TRI - Finish - Bracket - Photocell - Accessories - Warranty

1

2

3

4

5

6

7

8

1 Product

LED-ARL

2 Watts

15W 15W (1,947lm)
 30W 30W (3,819lm)
 50W 50W (7,048lm)
 80W 80W (11,200lm)

3 Color

TRI Switchable
 30K/40K/50K

4 Finish

BZ Bronze
 WH White
 CS Custom*

5 Bracket

TR Trunnion
 KN Knuckle
 A&D* Straight Arm & Slip Fitter Adjustable Combo

6 Photocell

(Blank) None
 PC* 120/277 Photocell*

7 Accessories

(Blank) None
 WG Wire Guard
 SHIELD Shield

8 Warranty

(Blank) 5 Year (incl.)
 10YR 10 Year

*A 7 day lead time will be required for a custom finish

*Straight Arm / Slip Fitter Adjustable Combo only available in 50W and 80W

*White only for KN Bracket

Specs and model numbers are subject to change with or without notice



90° Tilt Angle

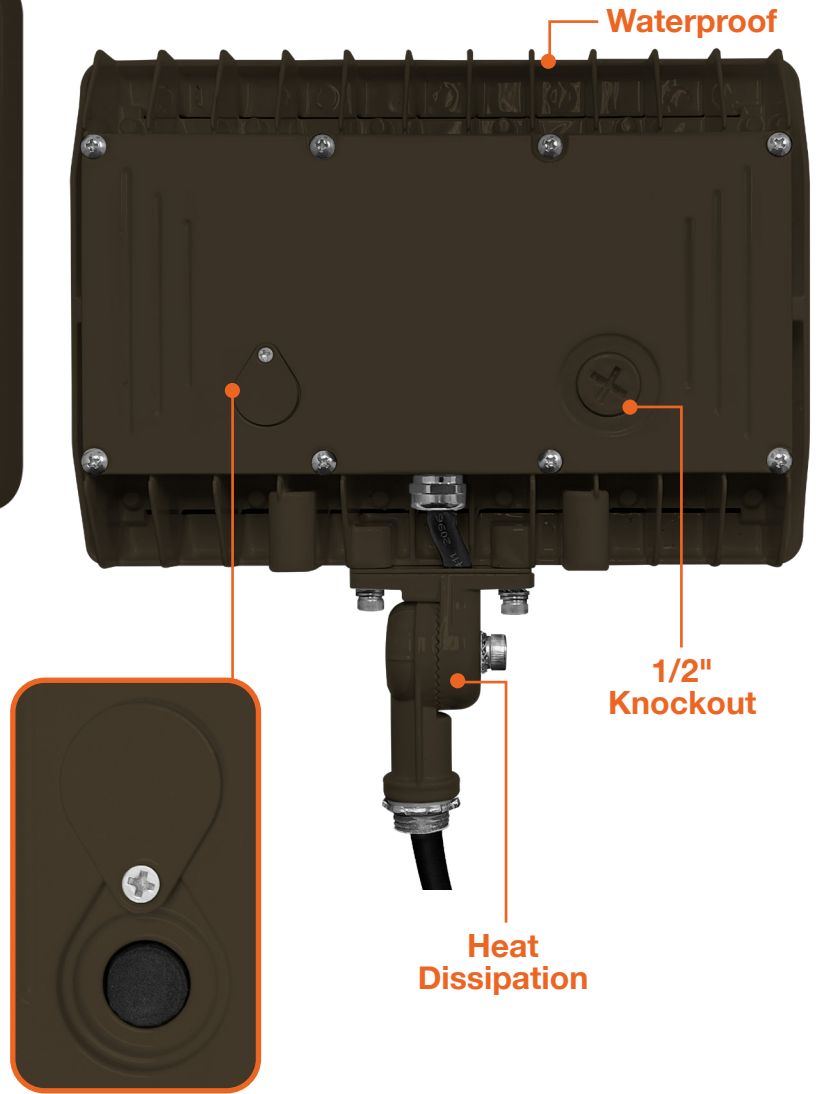

Optional Accessories

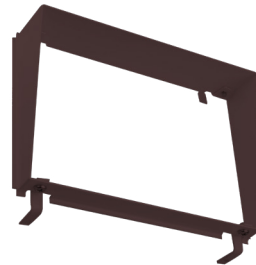

ARL Shield
 ARL-15/30W-SHIELD-BZ
 ARL-15/30W-SHIELD-WH
 ARL-50W-SHIELD-BZ
 ARL-50W-SHIELD-WH
 ARL-80W-SHIELD-BZ
 ARL-80W-SHIELD-WH

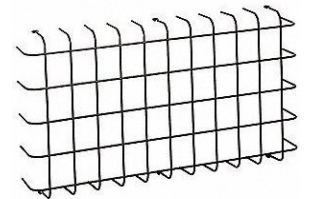

ARL Wireguard
 ARL-15/30W-WG
 ARL-50W-WG
 ARL-80W-WG

DIMENSIONS

IN STOCK MODELS

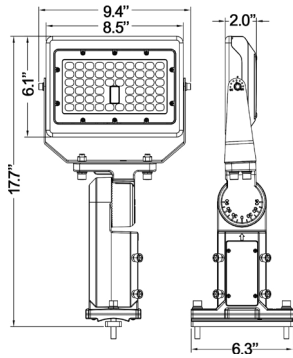

Straight Arm / Slip Fitter Adjustable Combo - 50W

- Pole Bolt Pattern: 51/2"
- Ø5/16" Hole

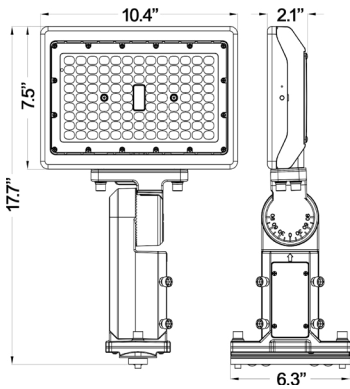

Straight Arm / Slip Fitter Adjustable Combo - 80W

- Pole Bolt Pattern: 51/2"
- Ø5/16" Hole

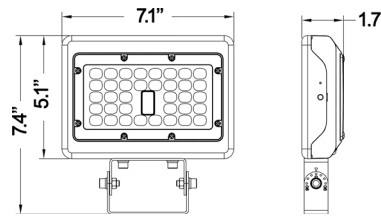

Trunnion Bracket - 15W/ 30W

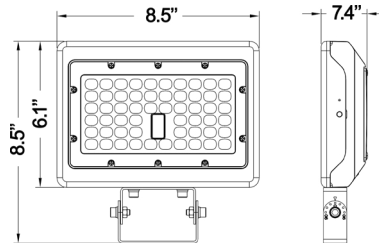

Trunnion Bracket - 50W

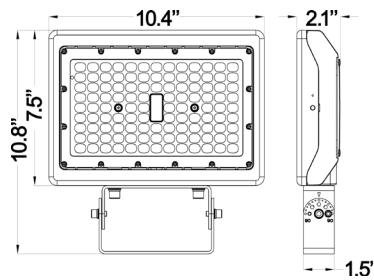

Trunnion Bracket - 80W

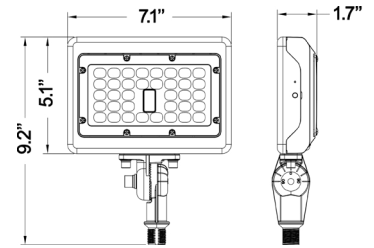

Knuckle Bracket - 15W/30W

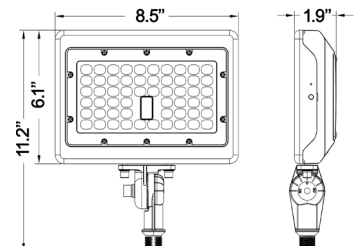

Knuckle Bracket - 50W

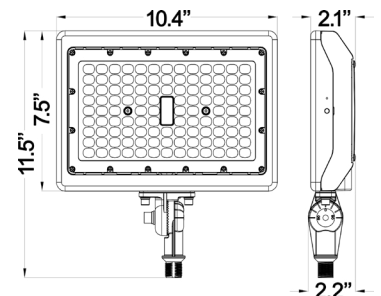

Knuckle Bracket - 80W

15W 3CCT Selectable

Model	Voltage	Watts	Lumens	Color	CRI
LED-ARL-15W-TRI-BZ-TR	120-277V	15w	1,947	50/40/30k	>80
LED-ARL-15W-TRI-BZ-KN	120-277V	15w	1,947	50/40/30k	>80
LED-ARL-15W-TRI-WH-KN	120-277V	15w	1,947	50/40/30k	>80

30W 3CCT Selectable

Model	Voltage	Watts	Lumens	Color	CRI
LED-ARL-30W-TRI-BZ-TR	120-277V	30w	3,819	50/40/30k	>80
LED-ARL-30W-TRI-BZ-KN	120-277V	30w	3,819	50/40/30k	>80
LED-ARL-30W-TRI-WH-KN	120-277V	30w	3,819	50/40/30k	>80

50W 3CCT Selectable

Model	Voltage	Watts	Lumens	Color	CRI
LED-ARL-50W-TRI-BZ-TR	120-277V	50w	7,048	50/40/30k	>80
LED-ARL-50W-TRI-BZ-KN	120-277V	50w	7,048	50/40/30k	>80
LED-ARL-50W-TRI-WH-KN	120-277V	50w	7,048	50/40/30k	>80
LED-ARL-50W-TRI-BZ-SFA	120-277V	50w	7,048	50/40/30k	>80

80W 3CCT Selectable

Model	Voltage	Watts	Lumens	Color	CRI
LED-ARL-80W-TRI-BZ-KN	120-277V	80w	11,200	50/40/30k	>80
LED-ARL-80W-TRI-WH-KN	120-277V	80w	11,200	50/40/30k	>80
LED-ARL-80W-TRI-BZ-TR	120-277V	80w	11,200	50/40/30k	>80
LED-ARL-80W-TRI-BZ-SFA	120-277V	80w	11,200	50/40/30k	>80

PHOTOMETRICS

Luminous Intensity Distribution Curve(cd/klm)

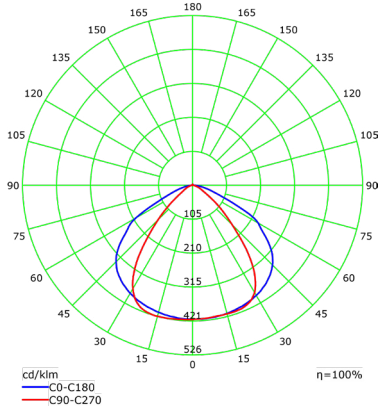

15W

Luminous Intensity Distribution Curve(cd/klm)

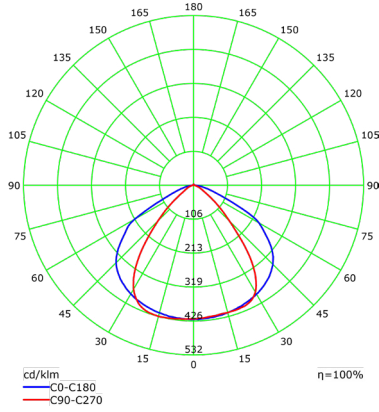

30W

Luminous Intensity Distribution Curve(cd/klm)

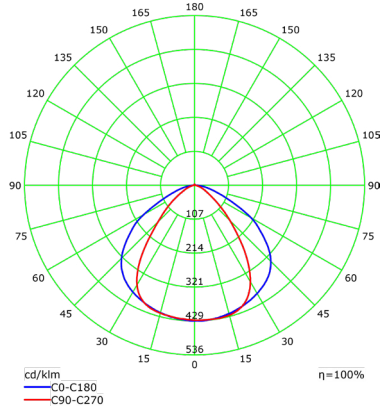

50W

Luminous Intensity Distribution Curve(cd/klm)

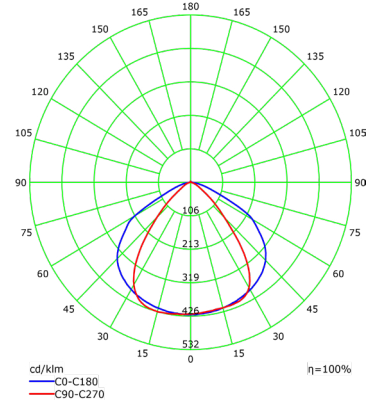

80W

Illuminance at a Distance(Beam Angle)

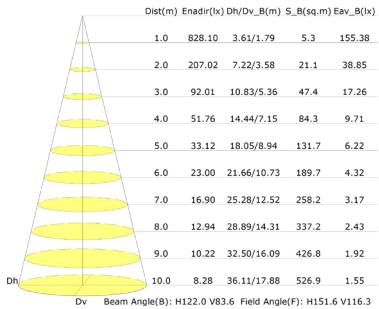

15W

Illuminance at a Distance(Beam Angle)

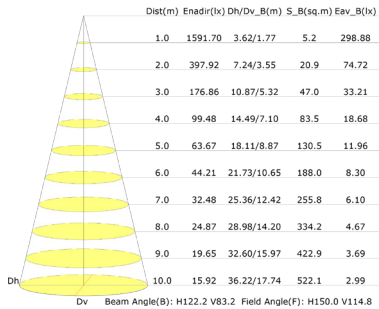

30W

Illuminance at a Distance(Beam Angle)

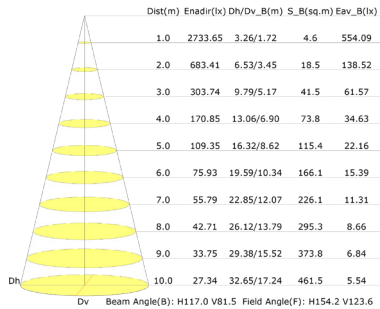

50W

Illuminance at a Distance(Beam Angle)

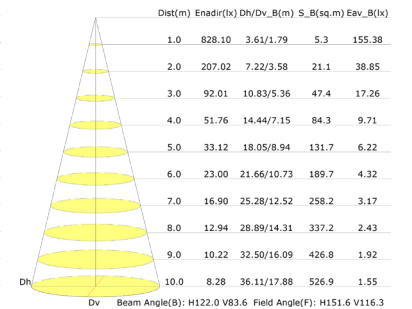

80W

ARL 15 / 30 / 50 / 80W EPA RATING	YK	TR	KN	SA	SF	SFA
15W	0.12ftsq.	0.12ftsq.	0.12ftsq.			
30W	0.3ftsq.	0.3ftsq.	0.35ftsq.			
50W	0.43ftsq.	0.43ftsq.	0.48ftsq.	0.61ftsq.	0.58ftsq.	0.68ftsq.
80W	0.64ftsq.	0.64ftsq.	0.69ftsq.	0.82ftsq.	0.79ftsq.	0.87ftsq.