



HITCH INSTALLATION INSTRUCTIONS

MAKE: VOLKSWAGEN
YEARS: 2018 - 2021
MODEL/TRIM: GOLF GTI (MK7.5 CHASSIS)
 2019 GTI RABBIT EDITION

www.stealthhitches.com 833-694-4824

RACK RECEIVER KIT#: **SHR34002**

COMPATIBLE WITH TOW KIT: **SHT25006**

2" RACK RECEIVER MAXIMUM PAYLOAD: 350 LBS
MAXIMUM TOW RATING: 3500 LBS
MAXIMUM TONGUE WEIGHT: 350 LBS



UNDER VEHICLE TRIMMING:

HEAT SHIELD: **NO**
 FASCIA: **YES**
 GRAVEL GUARD TRIMMING: **NO**



READ ALL INSTRUCTION WARNINGS AND LABELS



NO WELDING, METAL DRILLING OR VISIBLE TRIMMING REQUIRED

PARTS SUPPLIED WITH RACK RECEIVER KIT:

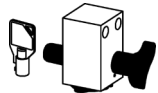

LATCH BLOCK & KEYS



(2) BOLTS
5/8"-11 x 5"



(2) 5/8"
NYLOCK NUTS



2" RACK
RECEIVER



(7) BOLTS
M8 - 1.25 x 40



(7) M8 FLAT
WASHERS



(7) M8 LOCK
WASHERS



(2) BOLTS
7/16" x 1-1/2"



(2) 7/16" FLAT
WASHERS



(2) 7/16" LOCK
WASHERS

ADDITIONAL PARTS FOR TOW KIT:



BALL MOUNT
7" RISE, SHORT



CHAIN HOOKS



2" BALL

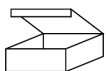

PASSIVE WIRING
KIT BOX

TOOLS REQUIRED:



15/16" OPEN
END WRENCH



13mm, 5/8", &
15/16" SOCKETS

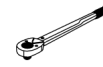

TORQUE
WRENCH

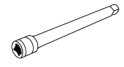

SOCKET
EXTENSION



SAFETY GLASSES



RATCHET



FLASHLIGHT



PLASTIC
PRY TOOLS



90 DEGREE
PICK



T15 & T25
TORX



DREMEL TOOL



FILE

ADDITIONAL TOOLS FOR TOW KIT:



MULTIMETER



STRIPPER/
CRIMPING
TOOL



PLIERS



DRILL &
3/8" BIT



T30 TORX



SILICONE



10mm
SOCKET

<THESE INSTRUCTIONS MUST BE GIVEN TO THE END USER>

NOTICE: Installation of Stealth products may or may not require the addition of a wiring harness to the vehicle.

- The Rack Receiver only product does not require adding a wiring harness.
- The Rack Receiver plus Tow Kit requires the addition of a "Passive" wiring harness to the vehicle. The passive harness "reads" the output of the vehicle's lights and translates the signals to the trailer without being connected to the vehicle computer.

INSTALLATION NOTE: In most instances, these instructions will only outline disassembly of vehicle components. Re-installation of components will require the installer to retain vehicle hardware and work through disassembly instructions in reverse order. When installation is complete, double check that all vehicle components have been replaced and are secured.

IMPORTANT SAFETY NOTICE FOR STEALTH HITCH INSTALLERS AND CUSTOMERS.

Read all installation and operating instructions along with all labels before installing or using this product. Do not perform any installation or towing procedures without fully understanding the correct tools and actions for all steps. Call for support if needed.

⚠ WARNING Failure to comply with the safety information in these instructions could result in serious injury or death.

- ⚠ Do not modify this product in any manner. Doing so could alter its integrity and lead to a loss of attachment between the trailer and the tow vehicle.
- ⚠ Adding Stealth hitch components to the chassis of any vehicle can be hazardous. There is potential for unexpected combustion of fuel, electric shock, burns, shifting or falling of unstable vehicle, damage to vehicle, injury from tool usage and many other hazards. This installation must be completed by someone who is aware of the hazards involved. This person must be knowledgeable of proper safety procedures for a vehicle modification of this nature, and for usage of the equipment required to perform the installation.
- ⚠ Without proper knowledge, towing can be a dangerous activity. Understand all the risks involved with towing before proceeding. For information on towing safety, see "**The Trailer Handbook: A Guide to Understanding Trailer and Towing Safety**" from the National Association of Trailer Manufacturers, www.NATM.com and your trailer and tow vehicle manufacturer's owner's manual.
- ⚠ Do not exceed tow or tongue rating of coupler, tow or tongue rating of hitch, or tow or weight ratings of tow vehicle or trailer. See vehicle and trailer manufacturer information for ratings. Exceeding these ratings may cause damage to towing components or loss of attachment between the trailer and vehicle.
- ⚠ While installation is being performed, check for signs of damage or excessive corrosion. Do not install hitch components over vehicle parts that are broken or have compromised structural integrity.
- ⚠ This product was designed to fit vehicles in their original, "as manufactured" condition. Compatibility with vehicles having replacement parts, or other modifications is not guaranteed. Inspect vehicle for modifications before installation of this product.
- ⚠ Some accessories, like the rack receiver, are not rated for towing. Do not use any accessories without proper knowledge of their use.
- ⚠ A visual inspection of the hitch should be performed before each use. Regularly check that all connections are secure, including those that secure the hitch to the vehicle. Check for cracks or damage to the hitch. Do not use the hitch if cracks or damage outside of normal wear is found. Using a hitch that has unsecure connections and/or cracks or damage could result in damage to the tow vehicle, trailer, towing components and loss of attachment between the tow vehicle and trailer.
- ⚠ Stealth hitches are not compatible with any weight distribution or sway control products. Adding additional products to the trailer or chassis which modifies the function of the Stealth hitch may cause hitch failure.

NOTICE: Installation of hitch requires removal of vehicle parts and interaction with vehicular electronics. Before installation, check the condition of body panels and note any locations where panels are not flush. Check the electronic functions of the vehicle, such as: headlights, taillights, turn signals, cameras, backup sensors, Parking Distance Controller (PDC), foot activated cargo access, etc. It is the responsibility of the installer to restore the fit and function of the vehicle

GAIN ACCESS TO MOUNTING AREA



1. Open the cargo area door. Locate the plastic spring-loaded wing nut inside the cargo area, behind the taillight. Turn wing nut counterclockwise to release taillight. Slide taillight rearward. Use a plastic pry tool, if necessary. Unplug and remove the taillights.

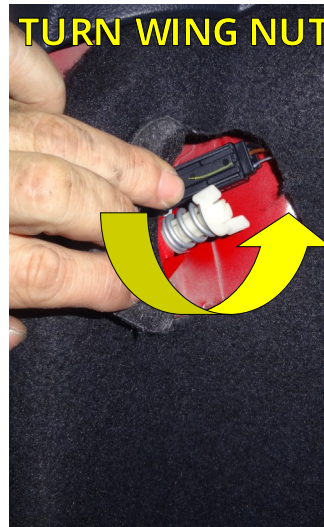

2. Inside the rear wheel well, behind the tire, locate (4) screws which are holding the wheel well liner (yellow arrows). Remove these screws and fold the flexible liner back toward the tire. Behind the liner locate and remove (1) additional screw (green arrow). Remove (1) screw from the bottom of the fascia (red arrow). Repeat on other side of vehicle.



3. Under the rear of the vehicle, use a T25 Torx to remove (2) screws from the bottom of the fascia. Use a T15 Torx to remove (2) screws.



GAIN ACCESS TO MOUNTING AREA CONTINUED



PLASTIC
PRY TOOLS

4. The rear fascia is clipped to the vehicle body above and behind the wheel wells. Pull outward on the top front of the rear fascia to expose clips in the seam. Push down on the exposed clips to disconnect. Continue until all clips are disconnected. Repeat on other side of vehicle.
5. With a partner pull the fascia rearward. Remove the fascia completely.

NOTICE: Carefully remove the fascia and place on a blanket or pad.



13mm
SOCKET

6. Remove the foam piece. Remove (7) bolts from the factory reinforcement beam. Discard the factory reinforcement beam, foam piece, and bolts.

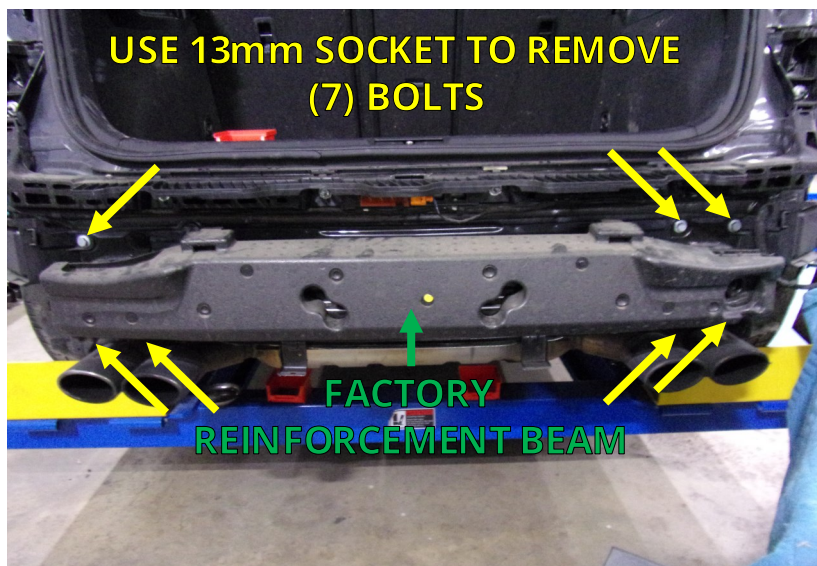

INSTALL STEALTH HITCH FRAME



13mm
SOCKET



5/8"
SOCKET



TORQUE
WRENCH

7. Slide the hitch tabs into the exposed chassis channel and align the hitch holes with the bolt holes on the rear of the vehicle. On the outside of each chassis beam, insert a supplied 7/16" bolt, lock washer, and flat washer on each side and hand tighten. Use (7) supplied M8 bolts, lock washers, and flat washers to fasten the hitch. Torque the (7) M8 bolts to 20 ft.-lbs. and the (2) 7/16" bolts to 65 ft.-lbs.

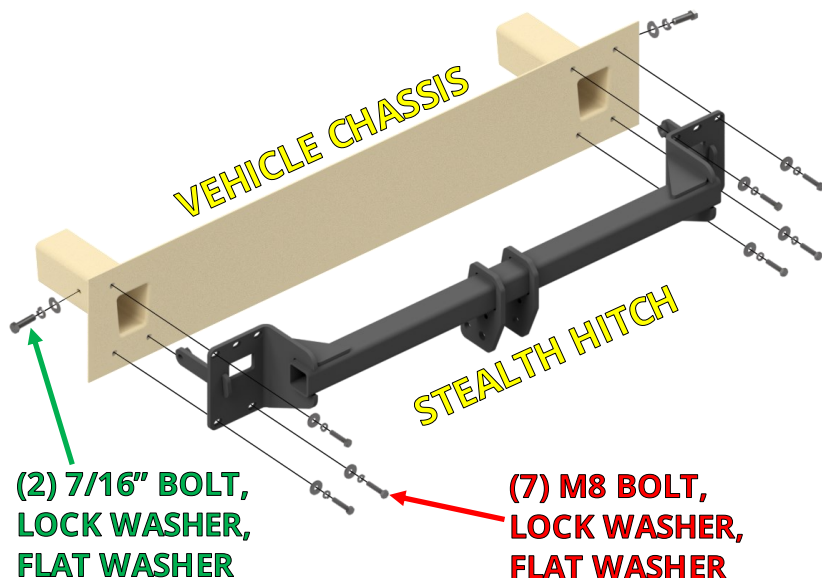

MOUNT LATCH BLOCK



15/16"
SOCKET



15/16" OPEN
END WRENCH



TORQUE
WRENCH

8. Installation of the latch block varies depending on which kit you are installing.

- **Rack Receiver Kit:** Install the latch block with (2) 5/8"-11 x 5" bolts and (2) 5/8" nylock nuts. Tighten each bolt to 150 ft.-lbs.
- **Tow Kit:** Install the latch block and (2) chain hooks with (2) 5/8"-11 x 5" bolts and (2) 5/8" nylock nuts. Tighten each bolt to 150 ft.-lbs.

NOTICE: Keys are packaged within the latch block, remove keys and store in safe location.

RACK RECEIVER KIT INSTALL



TOW KIT INSTALL

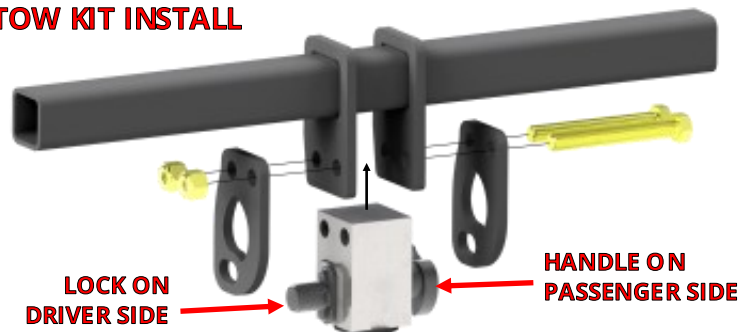

IF INSTALLING A RACK RECEIVER KIT, SKIP TO STEP 27.
IF INSTALLING A TOW KIT, CONTINUE TO STEP 9.

INSTALL PASSIVE WIRING KIT

#	DESCRIPTION	QTY
1	4-WAY CONNECTOR HARNESS	1
2	CONTROL MODULE	1
3	4-WAY CONNECTOR COVER	1
4	CABLE TIE - 8"	8
5	CABLE TIE - 14"	2
6	MAGNETIC CABLE HOLDER	1
7	M8 SERRATED FLANGE NUT	1
8	FORK TERMINAL	1
9	ADHESIVE FOAM STRIP	2
10	BUTT CONNECTOR (BLUE)	1
11	BUTT CONNECTOR (RED)	4
12	CLAMP-ON CONNECTORS	4
13	POWERWIRE	1



9. Locate the wiring kit box. Review the contents of the box against the list above to check for missing components. The passive wiring kit uses a control module to manage the functions of the trailer lighting. The module has an "input" side that receives power from the vehicle's battery and signals from the vehicle's taillights. The "output" side of the module delivers this information to the 4-way plug. The control module is connected to the vehicle's battery and taillight wiring as outlined in the next steps.

NOTICE: Do not allow electrical system to become disconnected from power or ground. Doing so may interrupt electrical systems.

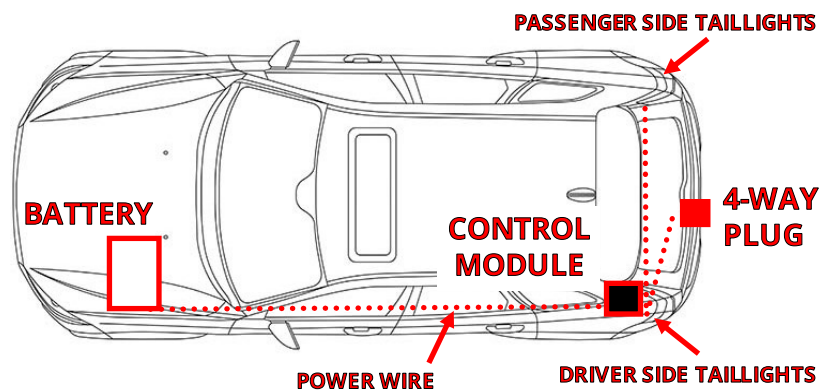
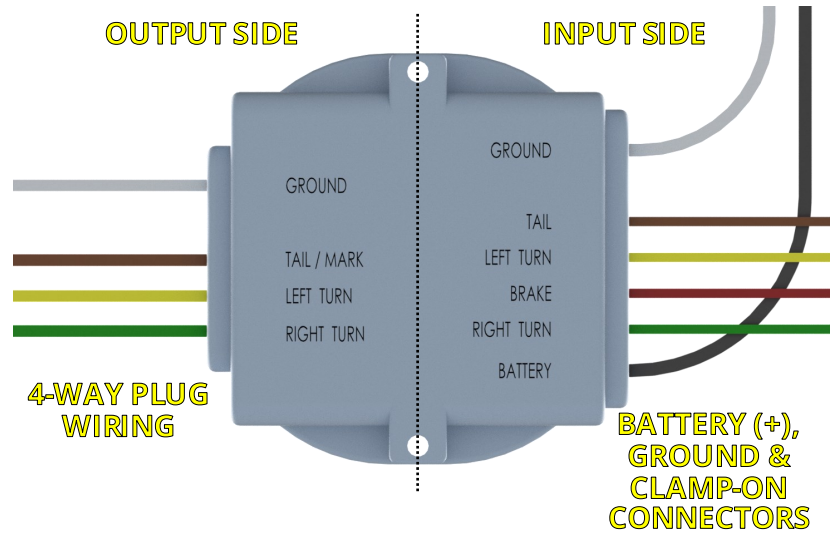

INSTALL WIRING KIT CONTINUED

10. Remove the cargo floor panel by lifting it up and out. Place panel and cargo holder on a blanket or safe area.
11. Remove threshold by pulling upwards. Place threshold on a blanket or safe area.



12. Locate rear driver side seatbelt trim panel. To gain access to plastic rivet, dislodge trim panel. Remove plastic rivet.



13. Locate (1) screw inside cylindrical protrusion. Remove screw with Torx socket. Dislodge top rear panel by pulling inward.

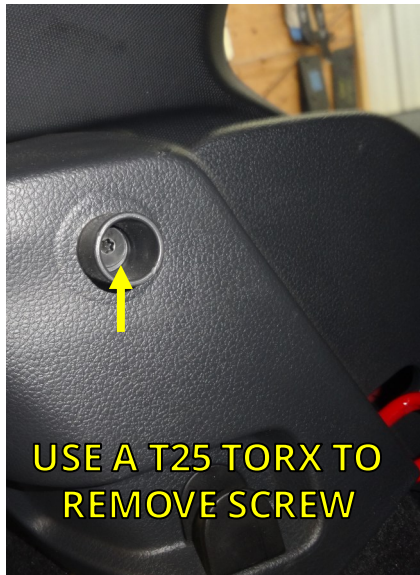

INSTALL WIRING KIT CONTINUED



T30 TORX



90 DEGREE PICK

14. Remove (2) cargo anchors by removing (2) screws. Remove (2) plastic rivets from side panel. Dislodge driver side rear panel to gain access to taillight wiring harness.



T30 TORX



90 DEGREE PICK

15. Remove (1) screw to remove cargo anchor on passenger side. Remove (2) plastic rivets from passenger side panel. Dislodge passenger side rear panel to gain access to taillight wiring harness.



DRILL & 3/8" BIT

16. Under the vehicle on the driver side, locate and remove the rubber grommet shown in the image. Drill 3/8" hole in grommet. Retrieve the power wire and the 4-way plug with wire. Pass the grommet over the wires so the plug will be on the outside of the vehicle. Thread the end of the wires into the hole and replace the grommet.



DRILL A 3/8" HOLE IN GROMMET



INSTALL WIRING KIT CONTINUED

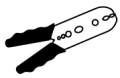

STRIPPER/
CRIMPING
TOOL

17. Locate the tail of the 4-way connector wire and the output side wires of the control module. Attach each similar color wire to each other using a red butt connector and crimping tool.

NOTICE (OPTIONAL): The butt connectors are heat shrink connectors. Apply heat to waterproof the connectors after crimping.

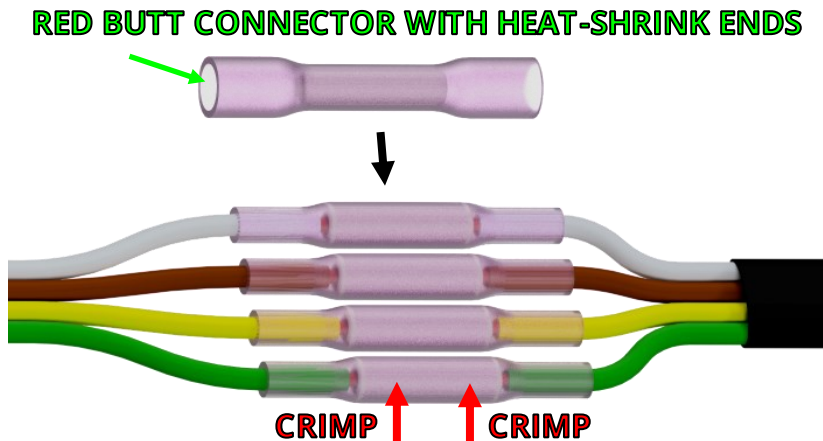

MATCH THE WIRE COLORS AND CRIMP EACH WIRE INTO THE SIDE OF EACH BUTT CONNECTOR. APPLY HEAT TO WATERPROOF AFTER CRIMPING

18. Secure harness to Stealth hitch frame with cable ties. Maintain an 18" loop from the cable tie to the 4-way plug. Add the magnetic cable holder and secure to the harness close to the 4-way plug, with a cable tie.

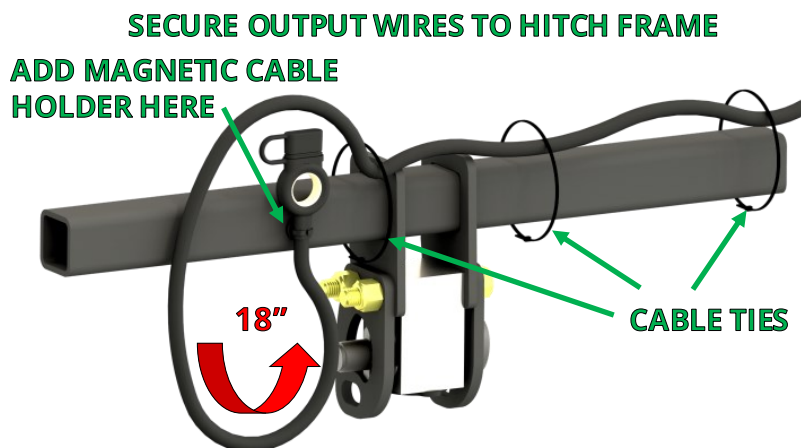

PLIERS



MULTIMETER

19. The wires on the input side of the module need to be attached to the vehicle wiring. Inside the driver side cargo compartment locate the indicated part of the vehicle wiring harness. Use clamp-on connectors to connect the brown and yellow wires to wires behind taillight. (As shown in reference table on next page.)

NOTICE: Verify wire signals with multimeter. Manufacturer may use different colors.

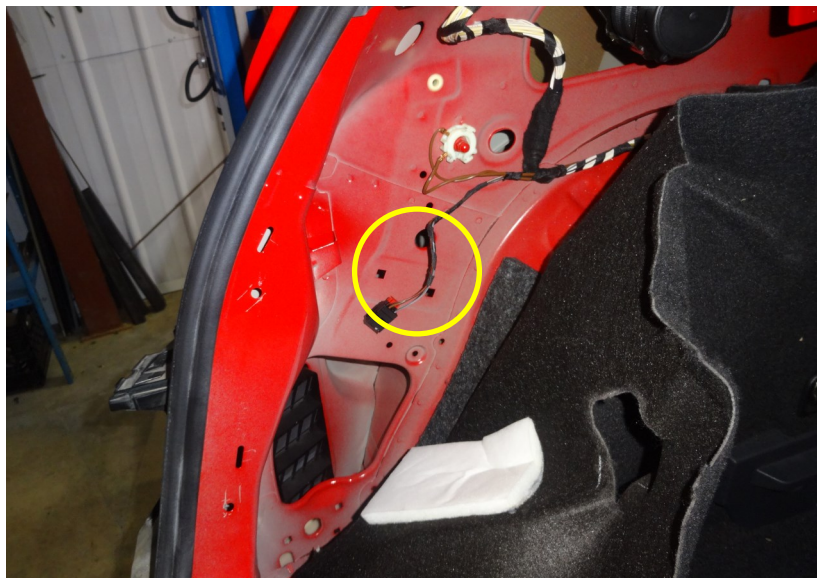

INSTALL WIRING KIT CONTINUED



PLIERS







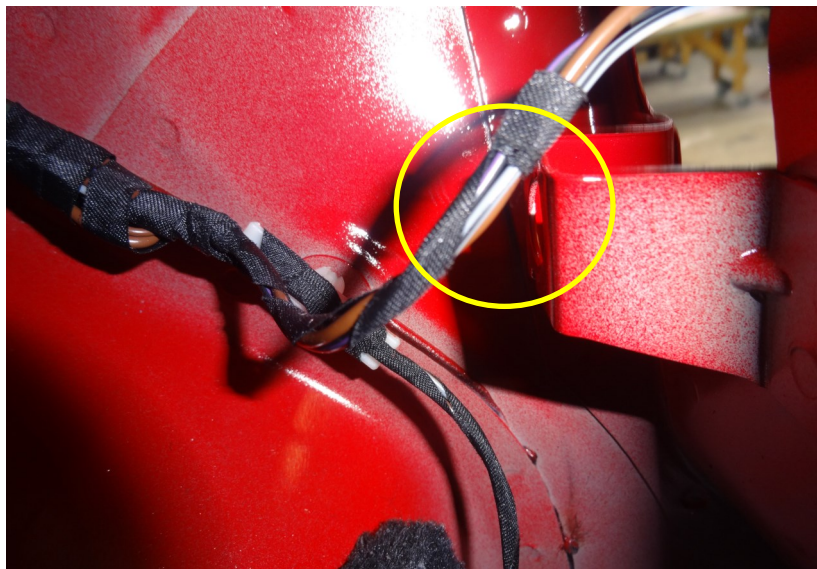



MULTIMETER

20. Use an existing vehicle wire harness as a guide to route the green input wire to the passenger side of the vehicle. Locate the indicated part of the vehicle wiring harness. Use a clamp-on connector to connect the green wire to right turn signal wire behind the taillight. (As shown in reference table below.)



CLAMP-ON CONNECTOR COLOR REFERENCE TABLE

SIGNAL INPUT WIRES			POWER & GROUND WIRES		
FUNCTION	HARNESS	VEHICLE			
LEFT TURN	 YELLOW	 BLACK/RED	12V+ (POWER)	 BLACK	BATTERY (+)
RIGHT TURN	 GREEN	 BLACK/PURPLE	GROUND	 WHITE	GROUND STUD
MARKER	 BROWN	 GRAY/BLACK	NOTICE: Do not connect the red brake wire. This vehicle does not utilize a separate brake circuit. The brake signal is sent down the left and right turn circuits simultaneously.		
BRAKE	 RED	NOT USED			

NOTE: If two colors are listed, the first color is the dominant color.



10mm
SOCKET



STRIPPER/
CRIMPING
TOOL

21. Locate the ground stud in the driver side cargo area. Trim white ground wire so it will reach stud without excess wire. Crimp supplied fork terminal to the ground wire with a crimping tool. Loosen the ground stud and secure the fork to the stud.

NOTICE: Loosen ground stud just enough to install fork terminal, so vehicle wiring does not lose ground.



INSTALL WIRING KIT CONTINUED



10mm
SOCKET

22. The power wire will need to be routed to the engine compartment where it will connect to the battery. Route the wire from the grommet to the gravel guard on the driver side undercarriage. Loosen the (4) nuts holding the gravel guard to allow routing through it. Then pass the wire up into the engine compartment.

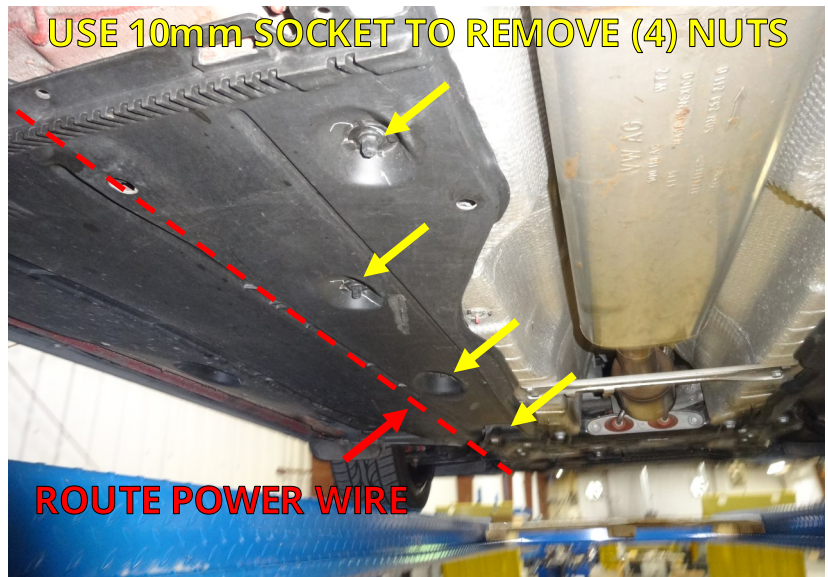

10mm
SOCKET

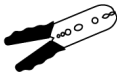

STRIPPER/
CRIMPING
TOOL

23. Remove battery cover. Route the power wire from the rear of firewall to the positive side of battery. Locate the fuse holder supplied in the wiring kit box. Remove the fuse from the fuse holder. Crimp the fuse holder lead to the black power wire. Connect the ring terminal to the positive battery terminal (+).



MULTIMETER



STRIPPER/
CRIMPING
TOOL



SILICONE

24. Feed the power wire through the hole in the grommet to inside of vehicle. Determine the amount of power wire needed to reach the control module inside the vehicle. Trim the control module power wire to remove excess length. Use the included blue butt connector to crimp the power wire leading from the battery to the control module power wire. Reinstall the 20 Amp fuse in the harness fuse holder located near the battery. Test the 4-way plug using a multimeter or connect the plug to a trailer and verify that the lights and brakes work correctly.

NOTE: Taillights will need to be temporarily plugged in during testing.

NOTICE (OPTIONAL): The butt splice connector is a heat shrink connector. Apply heat to waterproof the connector after crimping.

25. Secure all wires and wiring components. Replace the grommet removed earlier on the rear driver side of the vehicle. Use silicone to waterproof the grommet. Use the remaining cable ties to secure wiring so that it is not loose and will not interfere with replacement of the fascia. Wiring should not be visible once the vehicle is reassembled. Use the provided adhesive foam strips to secure the control module to an inside body panel.

26. Secure the gravel guard. Reinstall threshold and cargo area side panels, refer to Steps 10-15.

CUT ACCESS TO LATCH BLOCK

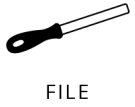

27. Cut out fascia with Dremel tool. Use a file to smooth out the cut.

DRIVER SIDE

PASSENGER SIDE

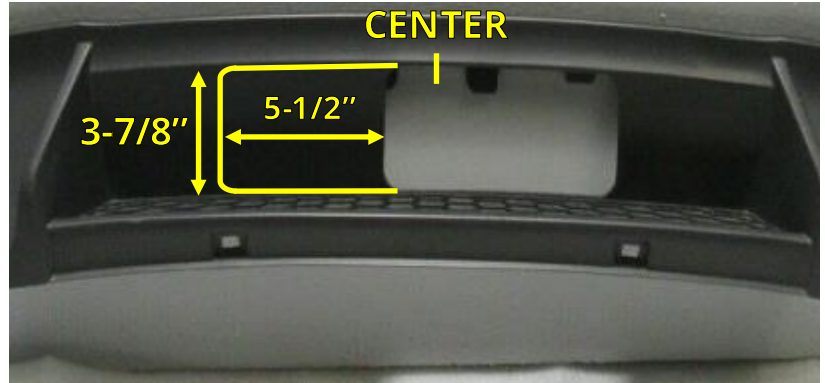

REINSTALL VEHICLE COMPONENTS

28. Reattach and secure the fascia, taillights, and other vehicle components in reverse order. Refer to Steps 1-5.



FINAL VEHICLE EXAMINATION

29. Examine the body panels to ensure that they are in a pre-installation condition. Test the electronic functions of the vehicle. Correct any inconsistencies.
30. Ensure that hitch components work properly.
 - **Verify that the lock works correctly.** Push in the safety lock on the latch block then unlock with key. The lock should slide back out with the key when unlocked.
 - **Verify that each accessory can be installed correctly.** Use the following steps to install and remove each accessory that will be used with the hitch. (*Rack Receiver and Ball Mount if purchased.*)
 1. Prepare latching mechanism. Turn handle clockwise if needed.
 2. Firmly insert "post" of accessory into latch block until handle releases indicating that the accessory is latched.
 3. Push in the safety locking pin until it fully engages. The locking pin prevents the handle from turning when pushed in, and confirms that the block is securely latched onto the accessory. The safety locking pin will not depress if the accessory is not fully latched.
 4. Use key to release safety locking pin.
 5. While holding on to the accessory, rotate handle clockwise to release and remove the accessory.
 - **Verify that no part of the accessories come into contact with the body of the vehicle.**

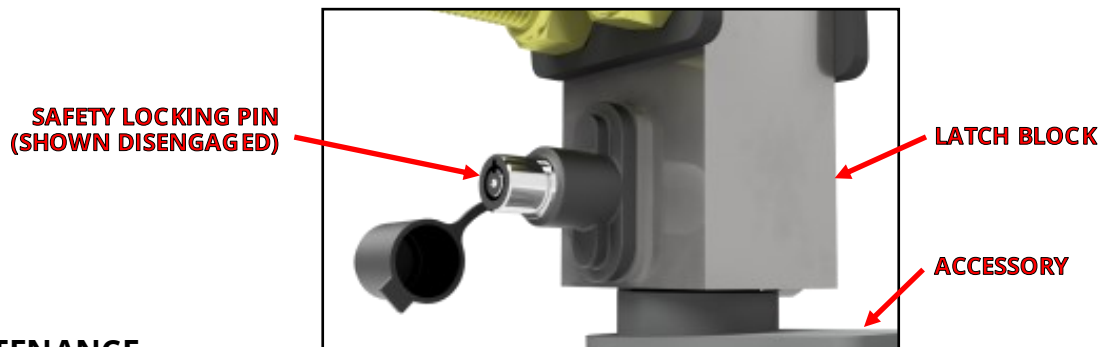

PRODUCT USE AND MAINTENANCE

NOTICE: If the hitch is being installed by a professional, the installer is responsible for training the end user in the use and maintenance of the product.

- **Accessory installation procedure:**
 1. Prepare latching mechanism. Turn handle clockwise if needed.
 2. Firmly insert "post" of accessory into latch block until handle spins counter-clockwise indicating that the accessory is latched.
 3. Always depress the safety locking pin and check that it has fully engaged.
- **Never use any accessory with the safety lock disengaged.** Until the safety locking pin is engaged, the handle is able to turn. A fully engaged safety locking pin is confirmation that the accessory is properly latched into the latch block.
- **Never use the rack receiver for towing.** The rack receiver accessory is only to be used with payload carrying products, such as bike racks or luggage racks.
- **Before each use, give the post of the accessory a light coating of lithium based grease.**
- **Before each use, inspect the hitch to ensure that all bolted connections are secure and that no cracks or damage are present.** Do not tow with the hitch if cracks or damage outside of normal wear is found.
- **Remove the Stealth accessories from the latch block after each use.** Do not leave accessories plugged in for extended periods of time.