



HITCH INSTALLATION INSTRUCTIONS

MAKE: AUDI
YEARS: 2017 - 2024
 2017 - 2021
 2018 - 2021
MODEL/TRIM: A4 ALLROAD
 A4 SEDAN
 S4 SEDAN

www.stealthhitches.com 833-694-4824

RACK RECEIVER KIT#: **SHR30006**

COMPATIBLE WITH TOW KIT: **SHT25002**

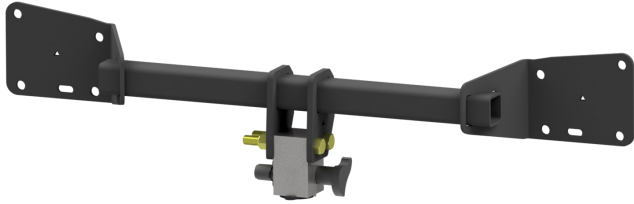

2" RACK RECEIVER MAXIMUM PAYLOAD: 350 LBS
MAXIMUM TOW RATING: 3500 LBS
MAXIMUM TONGUE WEIGHT: 350 LBS

UNDER VEHICLE TRIMMING:

HEAT SHIELD: **NO**
 FASCIA: **YES**
 GRAVEL GUARD TRIMMING: **NO**









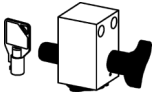

READ ALL INSTRUCTION WARNINGS AND LABELS





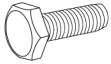







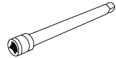

NO WELDING, METAL DRILLING OR VISIBLE TRIMMING REQUIRED



PARTS SUPPLIED WITH RACK RECEIVER KIT:

- | | | |
|--|--|--|
| 
LATCH BLOCK & KEYS | 
(2) BOLTS
5/8" - 11 x 5" | 
(2) 5/8"
NYLOCK NUTS |
| 
(6) 8" CABLE TIES | 
(6) CABLE TIE MOUNT | 
2" RACK RECEIVER |
| 
(6) M10 1.5 x 45mm BOLTS | 
(6) M10 FLAT WASHERS | 
(6) M10 LOCK WASHERS |



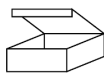

TOOLS REQUIRED:

- | | | | |
|---|---|---|--|
| 
15/16" OPEN END WRENCH | 
10mm, 16mm, 17mm, & 15/16" SOCKETS | 
TORQUE WRENCH | 
SOCKET EXTENSION |
| 
FLASHLIGHT | 
SAFETY GLASSES | 
RATCHET | 
FILE |
| 
PLASTIC PRY TOOLS | 
T25 TORX | 
SIDE CUTTERS | 
10 mm HOLLOW NUT DRIVER |
| 
DREMEL TOOL | 
90 DEGREE PICK | | |

ADDITIONAL PARTS FOR TOW KIT:

- | | | |
|--|--|--|
| 
BALL MOUNT
7" RISE, SHORT | 
CHAIN HOOKS | 
2" BALL |
| 
PASSIVE WIRING
KIT BOX | | |

ADDITIONAL TOOLS FOR TOW KIT:

- | | | | |
|--|---|---|---|
| 
MULTIMETER | 
STRIPPER/
CRIMPING
TOOL | 
PLIERS | 
SILICONE |
| 
DRILL &
3/8" BIT | | | |

<THESE INSTRUCTIONS MUST BE GIVEN TO THE END USER>

NOTICE: Installation of Stealth products may or may not require the addition of a wiring harness to the vehicle.

- The Rack Receiver only product does not require adding a wiring harness.
- The Rack Receiver plus Tow Kit requires the addition of a "Passive" wiring harness to the vehicle. The passive harness "reads" the output of the vehicle's lights and translates the signals to the trailer without being connected to the vehicle computer.









INSTALLATION NOTE: In most instances, these instructions will only outline disassembly of vehicle components. Re-installation of components will require the installer to retain vehicle hardware and work through disassembly instructions in reverse order. When installation is complete, double check that all vehicle components have been replaced and are secured.

IMPORTANT SAFETY NOTICE FOR STEALTH HITCH INSTALLERS AND CUSTOMERS.

Read all installation and operating instructions along with all labels before installing or using this product. Do not perform any installation or towing procedures without fully understanding the correct tools and actions for all steps. Call for support if needed.

WARNING

Failure to comply with the safety information in these instructions could result in serious injury or death.

-  Do not modify this product in any manner. Doing so could alter its integrity and lead to a loss of attachment between the trailer and the tow vehicle.
-  Adding Stealth hitch components to the chassis of any vehicle can be hazardous. There is potential for unexpected combustion of fuel, electric shock, burns, shifting or falling of unstable vehicle, damage to vehicle, injury from tool usage and many other hazards. This installation must be completed by someone who is aware of the hazards involved. This person must be knowledgeable of proper safety procedures for a vehicle modification of this nature, and for usage of the equipment required to perform the installation.
-  Without proper knowledge, towing can be a dangerous activity. Understand all the risks involved with towing before proceeding. For information on towing safety, see "**The Trailer Handbook: A Guide to Understanding Trailer and Towing Safety**" from the National Association of Trailer Manufacturers, www.NATM.com and your trailer and tow vehicle manufacturer's owner's manual.
-  Do not exceed tow or tongue rating of coupler, tow or tongue rating of hitch, or tow or weight ratings of tow vehicle or trailer. See vehicle and trailer manufacturer information for ratings. Exceeding these ratings may cause damage to towing components or loss of attachment between the trailer and vehicle.
-  While installation is being performed, check for signs of damage or excessive corrosion. Do not install hitch components over vehicle parts that are broken or have compromised structural integrity.
-  This product was designed to fit vehicles in their original, "as manufactured" condition. Compatibility with vehicles having replacement parts, or other modifications is not guaranteed. Inspect vehicle for modifications before installation of this product.
-  Some accessories, like the rack receiver, are not rated for towing. Do not use any accessories without proper knowledge of their use.
-  A visual inspection of the hitch should be performed before each use. Regularly check that all connections are secure, including those that secure the hitch to the vehicle. Check for cracks or damage to the hitch. Do not use the hitch if cracks or damage outside of normal wear is found. Using a hitch that has unsecure connections and/or cracks or damage could result in damage to the tow vehicle, trailer, towing components and loss of attachment between the tow vehicle and trailer.
-  Stealth hitches are not compatible with any weight distribution or sway control products. Adding additional products to the trailer or chassis which modifies the function of the Stealth hitch may cause hitch failure.

NOTICE: Installation of hitch requires removal of vehicle parts and interaction with vehicular electronics. Before installation, check the condition of body panels and note any locations where panels are not flush. Check the electronic functions of the vehicle, such as: headlights, taillights, turn signals, cameras, backup sensors, Parking Distance Controller (PDC), foot activated cargo access, etc. It is the responsibility of the installer to restore the fit and function of the vehicle.

GAIN ACCESS TO MOUNTING AREA

1. Inside the rear cargo area, on both sides, turn knob counterclockwise and remove the compartment storage covers. On the inside of the passenger side panel locate and remove the 12 Volt power supply outlet. Squeeze the plug to remove.



2. Remove the trunk floor panel by lifting it up and out. Place panel on blanket or safe area.



3. Some vehicles have a plastic frame in the cargo area which needs to be removed. Loosen the plastic strap holding the air compressor. Use a 90 degree pick tool to remove (4) plastic rivets holding the frame (yellow arrows).

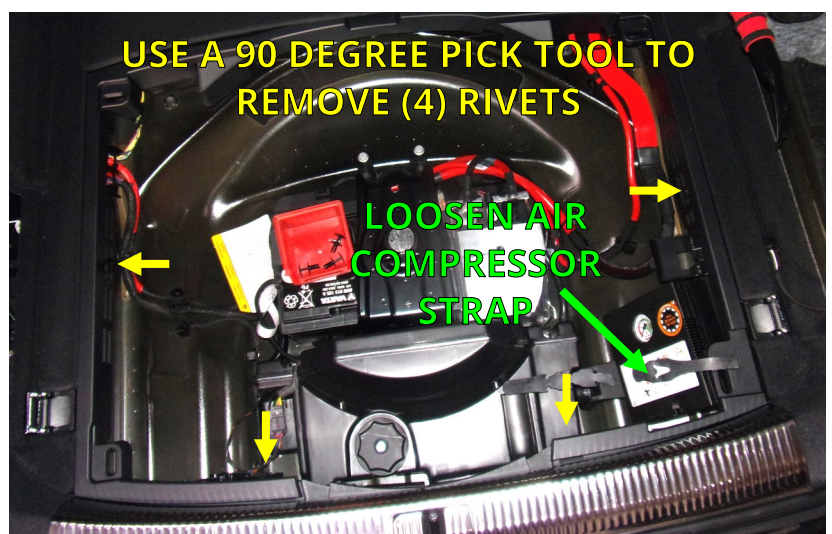

GAIN ACCESS TO MOUNTING AREA CONTINUED

- Lift up and remove the frame rail. Remove the air compressor from the cargo area. Lift up and remove the threshold in the rear of the cargo area.

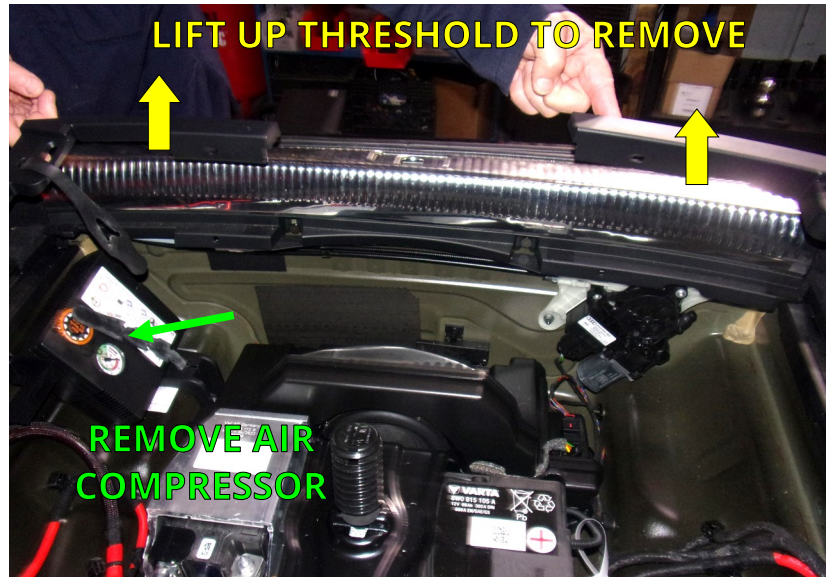

- Where the threshold was removed, locate the holes shown in the image. Remove the (2) nuts located in the holes with a hollow nut driver. Inside of the side cargo compartments, against the rear wall of the vehicle, are (2) additional nuts to remove.



- With a pry tool, remove taillight cover trim. Remove the (2) screws holding the taillight.



GAIN ACCESS TO MOUNTING AREA CONTINUED



- Slide the taillight to the rear of the vehicle. A plastic pry tool can be used to help if the light does not slide freely. Disconnect the light plug by pushing down on the clip and pulling the plug outward. Repeat Steps 6-7 on other side of vehicle.

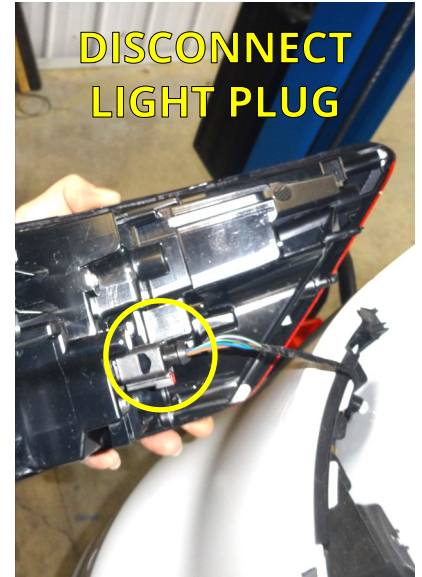

T25 TORX

- Inside the rear wheel well, behind the tire, locate the (3) screws which are holding the wheel well liner (yellow arrows). Remove these screws and fold the flexible liner back toward the tire. Behind the liner locate (1) additional screw and remove it (green arrow). Repeat on other side of vehicle.



T25 TORX

- 2017-2021 VEHICLES ONLY.** Under the rear of the vehicle, remove (2) screws from the bottom of the fascia.



GAIN ACCESS TO MOUNTING AREA CONTINUED



T25 TORX

10. 2022-2023 VEHICLES ONLY.

Under the rear of the vehicle, use a Torx to remove (2) screws. Use a socket to remove (2) nuts.



PLASTIC PRY TOOLS

11. A fascia lock pin was exposed on each side when the taillights were removed. This pin holds the fascia to the vehicle. Use a pry tool and lift up to remove the pin on each side of the vehicle.



PLASTIC PRY TOOLS

12. The rear fascia is clipped to the vehicle body above and behind the wheel wells. Pull outward on the top front of the rear fascia to expose a clip in the seam. With a plastic pry tool, push down on the exposed clip to disconnect. Continue to pull outward on the fascia and disconnect clips as they are exposed. Repeat on other side of vehicle.



GAIN ACCESS TO MOUNTING AREA CONTINUED



T25 TORX

13. The fascia will not be completely disconnected from the vehicle, a wiring harness attached to the fascia must remain attached. Before removing the rear fascia, set up a stand or place a pad down near the rear of the vehicle. Carefully pull the fascia away from the vehicle. Move the fascia away from the vehicle and place on the stand or pad prepared earlier.

NOTICE: Carefully remove the fascia and place on a blanket or pad.



NOTICE: If the electrical harness becomes disconnected the vehicle will need reprogramming at an Audi Dealership.



16mm
SOCKET

14. Remove the factory reinforcement beam. The beam is held onto the vehicle with (6) bolts and (1) nut. The nut is accessed inside the vehicle. **Save** the factory beam and nut for reinstallation, discard the 6 factory bolts.

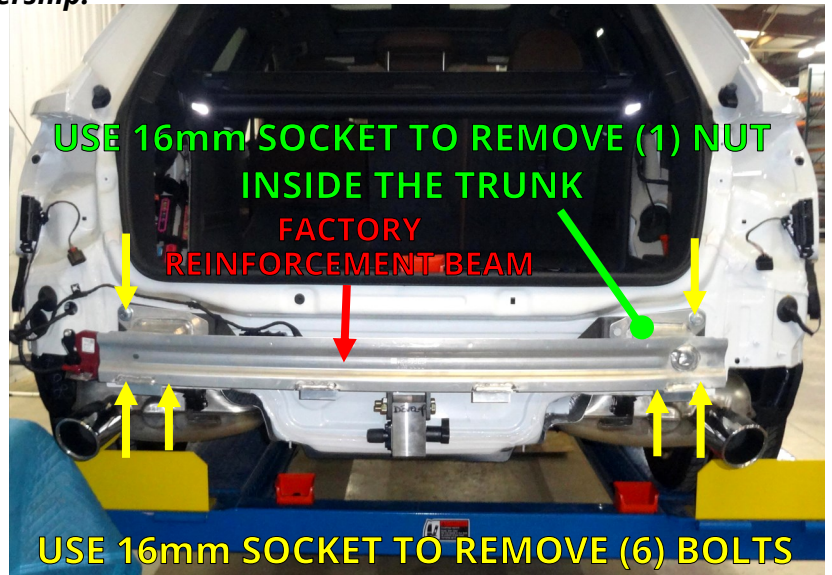

INSTALL STEALTH HITCH FRAME



16mm
SOCKET



17mm
SOCKET



TORQUE
WRENCH

15. Install the Stealth hitch frame and factory reinforcement beam onto the vehicle using (6) supplied M10 bolts, lock washers and flat washers, as shown. Use the saved nut on the factory reinforcement beam stud. Center the hitch frame and beam before tightening. Use a torque wrench to tighten the bolts to 45 ft.-lbs.

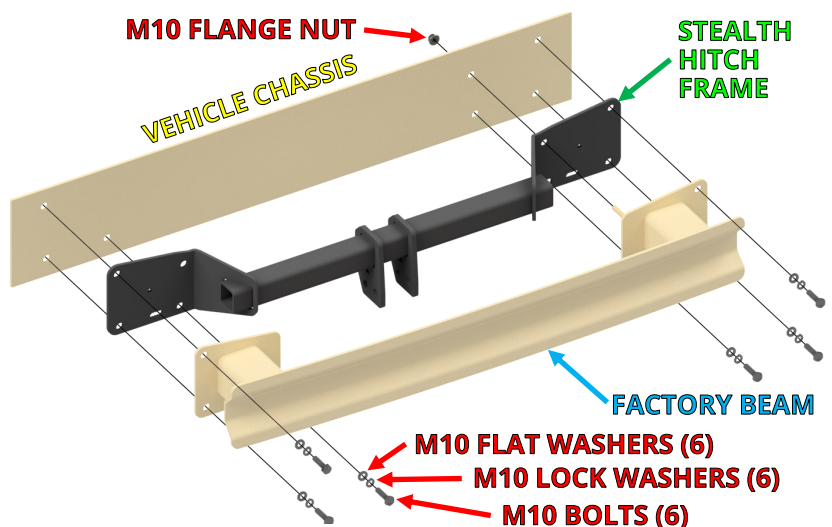

MOUNT LATCH BLOCK



15/16"
SOCKET



15/16" OPEN
END WRENCH



TORQUE
WRENCH

16. Installation of the latch block varies depending on which kit you are installing.

- **Rack Receiver Kit:** Install the latch block with (2) 5/8"-11 x 5" bolts and (2) 5/8" nylock nuts. Tighten each bolt to 150 ft.-lbs.
- **Tow Kit:** Install the latch block and (2) chain hooks with (2) 5/8"-11 x 5" bolts and (2) 5/8" nylock nuts. Tighten each bolt to 150 ft.-lbs.

NOTICE: Keys are packaged within the latch block, remove keys and store in safe location.

RACK RECEIVER KIT INSTALL

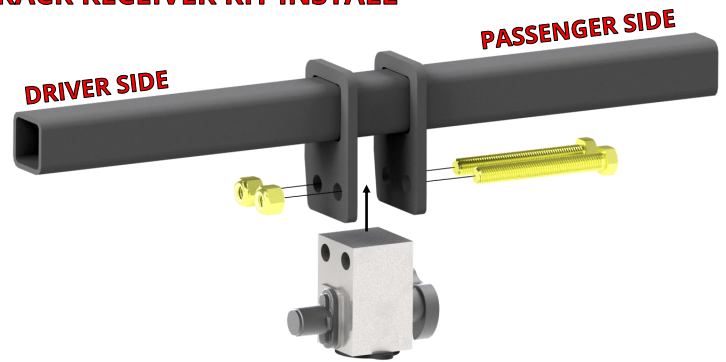

TOW KIT INSTALL

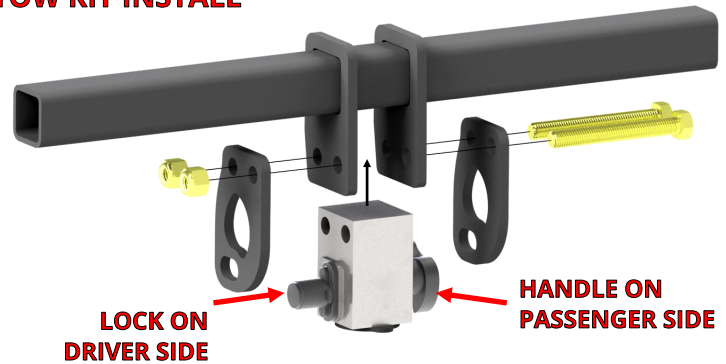

**IF INSTALLING A RACK RECEIVER KIT, SKIP TO STEP 30.
IF INSTALLING A TOW KIT, CONTINUE TO STEP 17.**

INSTALL PASSIVE WIRING KIT

#	DESCRIPTION	QTY
1	4-WAY CONNECTOR HARNESS	1
2	CONTROL MODULE	1
3	4-WAY CONNECTOR COVER	1
4	CABLE TIE - 8"	4
5	CABLE TIE - 14"	2
6	MAGNETIC CABLE HOLDER	1
7	M8 SERRATED FLANGE NUT	1
8	FORK TERMINAL	1
9	ADHESIVE FOAM STRIP	2
10	BUTT CONNECTOR (RED)	4
11	CLAMP-ON CONNECTORS	4

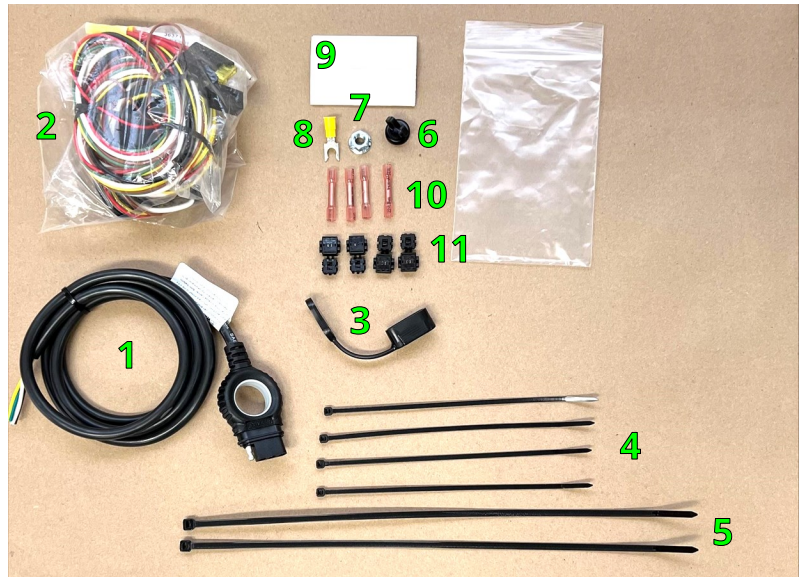

17. Locate the wiring kit box. Review the contents of the box against the list above to check for missing components. The passive wiring kit uses a control module to manage the functions of the trailer lighting. The module has an "input" side that receives power from the vehicle's battery and signals from the vehicle's taillights. The "output" side of the module delivers this information to the 4-way plug. The control module is connected to the vehicle's battery and taillight wiring as outlined in the next steps.

NOTICE: Do not allow electrical system to become disconnected from power or ground. Doing so may interrupt electrical systems

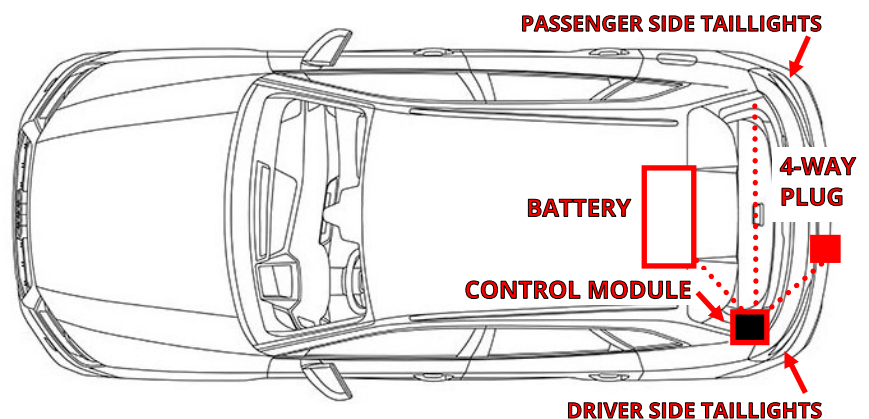
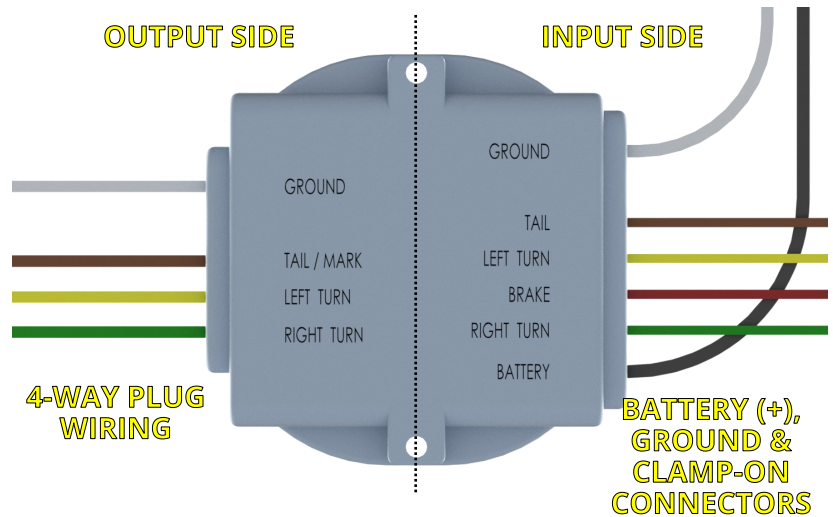

INSTALL WIRING KIT CONTINUED



DRILL &
3/8" BIT

18. Locate and remove rubber grommet from the driver side of the rear wall. Drill a 3/8" hole in the center of the grommet. Retrieve the 4-way connector harness. Pass the grommet over the wires so the plug will be on the outside of the vehicle. Thread the end of the wires into the hole and replace the grommet. Retrieve the control module from the wiring kit box and place it inside the cargo area behind the grommet.

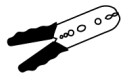

STRIPPER/
CRIMPING
TOOL

19. On the driver side of the vehicle, locate the tail of the 4-way connector wire and the output side wires of the control module. Attach each similar color wire to each other using a red butt connector and crimping tool.

NOTICE (OPTIONAL): The butt connectors are heat shrink connectors. Apply heat to waterproof the connectors after crimping.

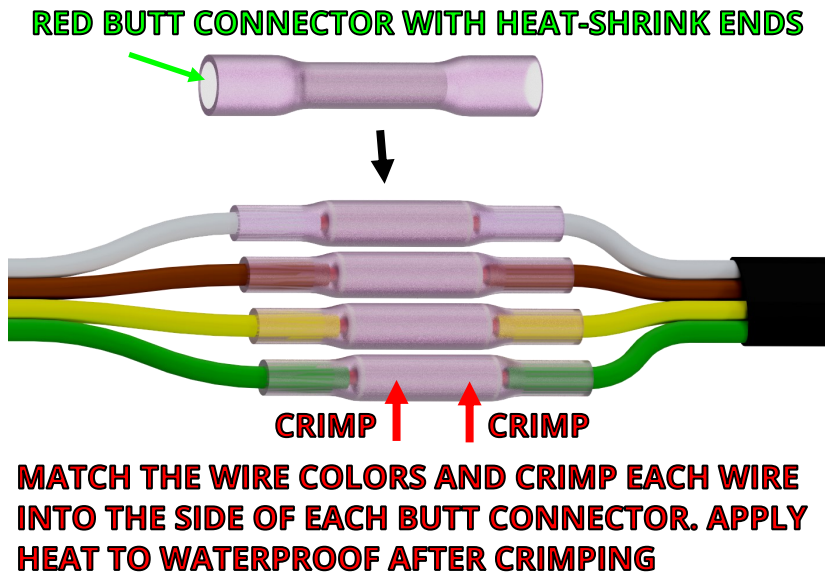

20. Secure harness to Stealth hitch frame with cable ties. Maintain an 18" loop from the cable tie to the 4-way plug. Add the magnetic cable holder and secure to the harness close to the 4-way plug, with a cable tie.

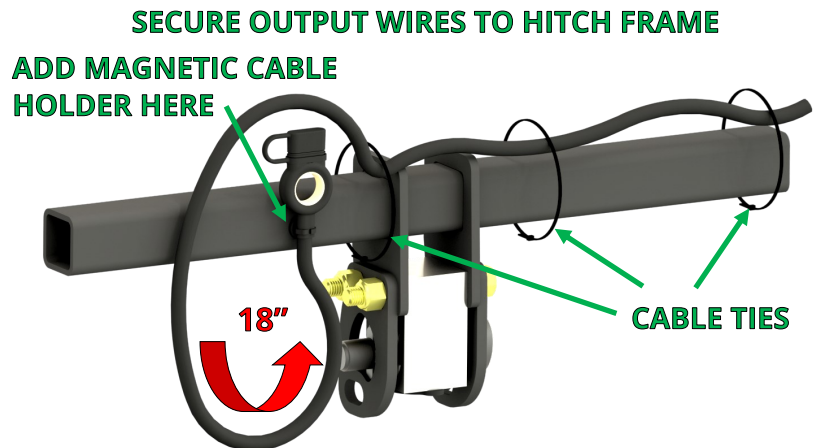

INSTALL WIRING KIT CONTINUED



PLIERS



MULTIMETER

21. The wires on the input side of the module need to be attached to the vehicle wiring. Inside the driver side cargo compartment locate the indicated part of the vehicle wiring harness. Use clamp-on connectors to connect the brown and yellow wires to wires behind taillight. (As shown in reference table below.)

NOTE: Vehicles may have different wire colors than those shown. Verify circuits (wire colors) with multimeter.

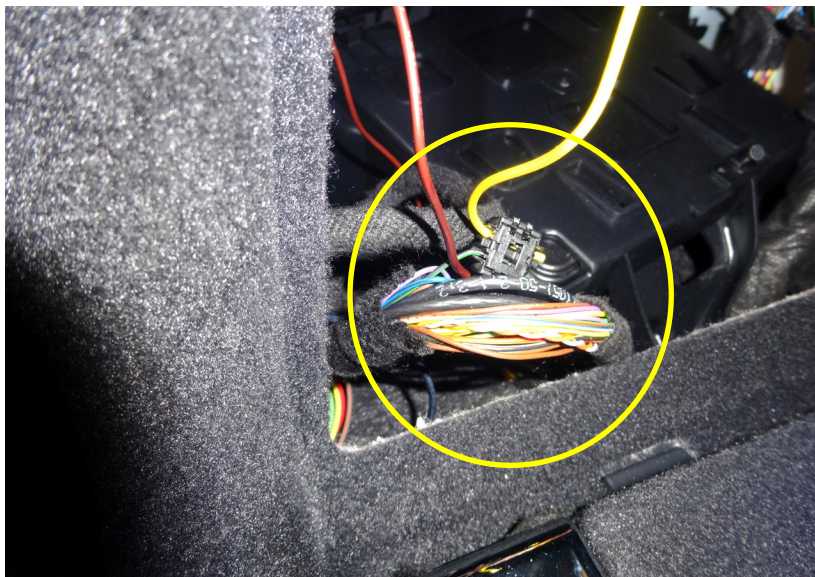

PLIERS



MULTIMETER

22. Use an existing vehicle wire harness as a guide to route the green input wire to the passenger side of the vehicle. Locate the indicated part of the vehicle wiring harness. Use a clamp-on connector to connect the green wire to right turn signal wire behind the taillight. (As shown in reference table below.)

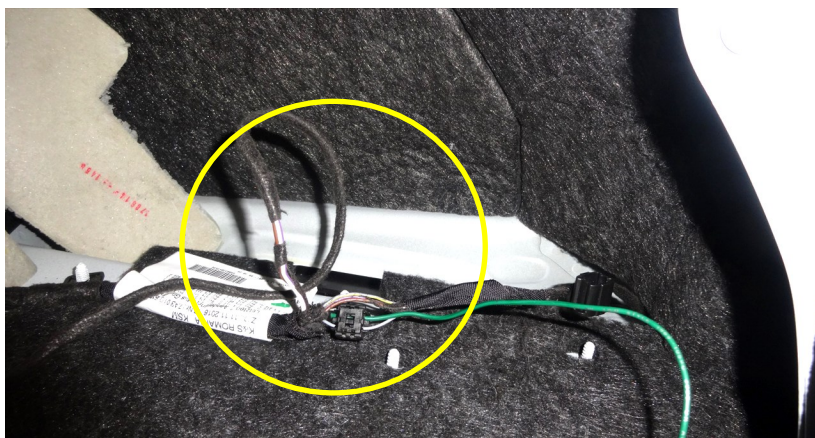

CLAMP-ON CONNECTOR COLOR REFERENCE TABLE

SIGNAL INPUT WIRES				POWER & GROUND WIRES		
FUNCTION	HARNESS	2017-2021	2021-2023	12V+ (POWER)	GROUND	BATTERY (+)
		VEHICLE	VEHICLE			
LEFT TURN	YELLOW	BLACK/GREEN	GREEN	BLACK		BATTERY (+)
RIGHT TURN	GREEN	GRAY	BLACK/BLUE		WHITE	BATTERY (-)
MARKER	BROWN	BLUE/BLACK	WHITE/GREEN	NOTICE: Do not connect the red brake wire. This vehicle does not utilize a separate brake circuit. The brake signal is sent down the left and right turn circuits simultaneously.		
BRAKE	RED					

NOTE: If two colors are listed, the first color is the dominant color.

NOTE: Vehicles from the 2021 model year may utilize either set of wire colors. To determine which column to reference, inspect the wire colors on the back of the driver side taillight. If the left turn and marker light wires are **BLACK/GREEN** and **BLUE/BLACK**, please use the **2017-2021** column. If the wires are **GREEN** and **WHITE/GREEN**, refer to the **2021-2023** column."



INSTALL WIRING KIT CONTINUED

23. Remove spare tire to get access to the battery. Turn knob counterclockwise.



10mm
SOCKET

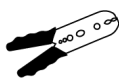

STRIPPER/
CRIMPING
TOOL

24. Locate the fork terminal supplied in the wiring kit box. Trim white ground wire so it will reach negative battery terminal (-) without excess wire. Crimp the fork terminal to the ground wire. Connect the ground wire to the negative battery terminal (-).



25. Locate the fuse holder supplied in the wiring kit box. Remove the fuse from fuse holder. Trim excess power wire length. Crimp fuse holder lead to power wire. Connect fuse holder ring terminal to the positive battery terminal (+).

NOTICE: Loosen battery terminals just enough to install wiring, so vehicle wiring does not lose ground or power.



MULTIMETER



SILICONE

26. Retrieve the adhesive foam strips from the wiring kit box. Secure the control module to a body panel inside the driver side cargo compartment.

27. Reinstall the 20 Amp fuse in the harness fuse holder located near the battery.

28. Test the 4-way plug using a multimeter or connect the plug to a trailer and verify that the lights and brakes work correctly.



NOTE: Taillights will need to be temporarily plugged in during testing.

26. Secure all wires and wiring components. Replace the grommet removed earlier on the rear driver side of the vehicle. Use silicone to waterproof the grommet. Use the remaining cable ties to secure wiring so that it is not loose and will not interfere with replacement of the fascia. Wiring should not be visible once the vehicle is reassembled.

CUT ACCESS TO LATCH BLOCK

30. 2017-2021 VEHICLES ONLY.

Detach the hands-free trunk release cable, from rear fascia.

NOTE: Make sure not to damage the cable during the removal of the cable and the fascia cut.

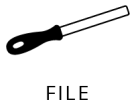

31. 2017-2021 VEHICLES ONLY.

Use a Dremel tool to cut out fascia, as shown. Use a file to smooth out the cut.

NOTE: Make sure the hands-free trunk release cable is removed before cutting.

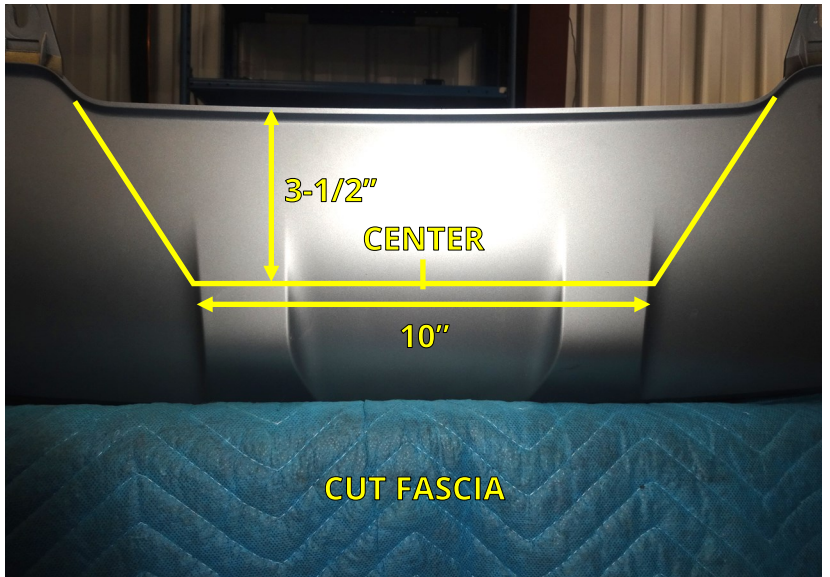

CABLE TIE MOUNT

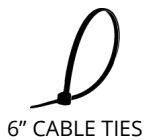

SIDE CUTTERS

32. 2017-2021 VEHICLES ONLY.

Reattach the hands-free trunk release cable using the (6) supplied cable tie mounts and cable ties. Secure the cable to the rear fascia as shown. Trim the cable ties when finished.

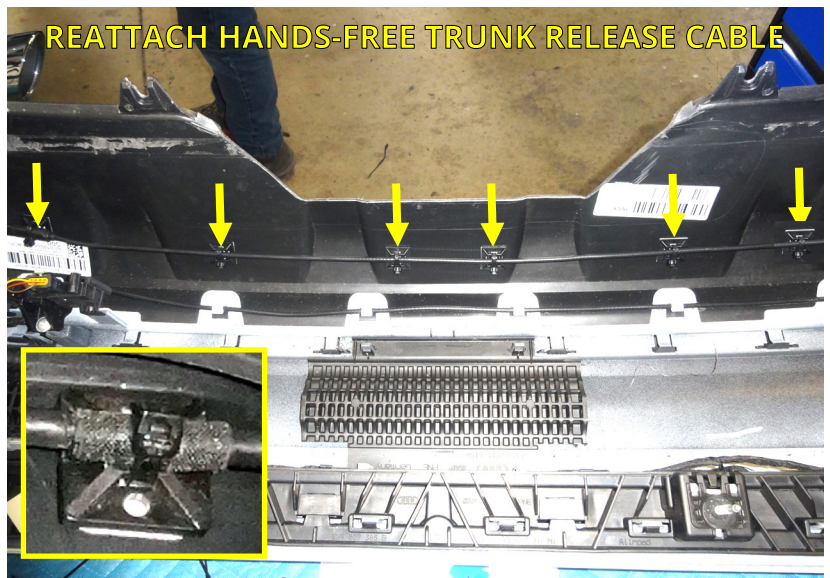

CUT ACCESS TO LATCH BLOCK CONTINUED

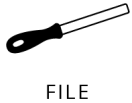

33. **2022-2023 VEHICLES ONLY.** Detach the hands-free trunk release cable, from rear fascia. Use a Dremel tool to cut out and remove the a plastic piece behind the fascia, as shown. Use a file to smooth out the cut.

NOTE: Make sure not to damage the cable during the removal of the cable and the fascia cut.

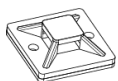

CABLE TIE MOUNT

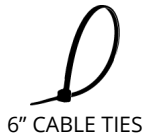

SIDE CUTTERS

34. **2022-2023 VEHICLES ONLY.** Use a Dremel tool to cut out fascia, as shown. Use a file to smooth out the cut. Reattach the hands-free trunk release cable using the (6) supplied cable tie mounts and cable ties. Secure the cable to the rear fascia as shown. Trim the cable ties when finished.



REINSTALL VEHICLE COMPONENTS

35. Reattach and secure the fascia, taillights, and other vehicle components in reverse order. Refer to Steps 1-13.

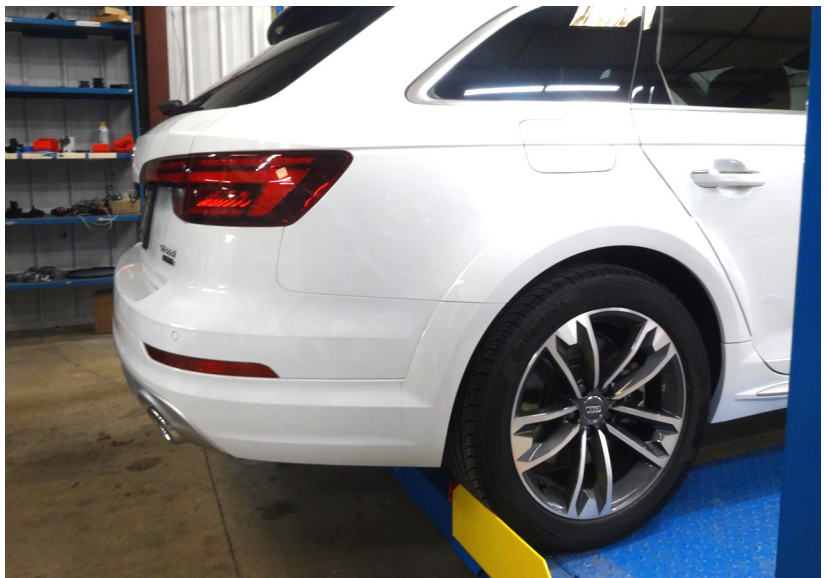

FINAL VEHICLE EXAMINATION

36. Examine the body panels to ensure that they are in a pre-installation condition. Test the electronic functions of the vehicle. Correct any inconsistencies.
37. Ensure that hitch components work properly.
 - **Verify that the lock works correctly.** Push in the safety lock on the latch block then unlock with key. The lock should slide back out with the key when unlocked.
 - **Verify that each accessory can be installed correctly.** Use the following steps to install and remove each accessory that will be used with the hitch. (*Rack Receiver and Ball Mount if purchased.*)
 1. Prepare latching mechanism. Turn handle clockwise if needed.
 2. Firmly insert "post" of accessory into latch block until handle releases indicating that the accessory is latched.
 3. Push in the safety locking pin until it fully engages. The locking pin prevents the handle from turning when pushed in, and confirms that the block is securely latched onto the accessory. The safety locking pin will not depress if the accessory is not fully latched.
 4. Use key to release safety locking pin.
 5. While holding on to the accessory, rotate handle clockwise to release and remove the accessory.
 - **Verify that no part of the accessories come into contact with the body of the vehicle.**

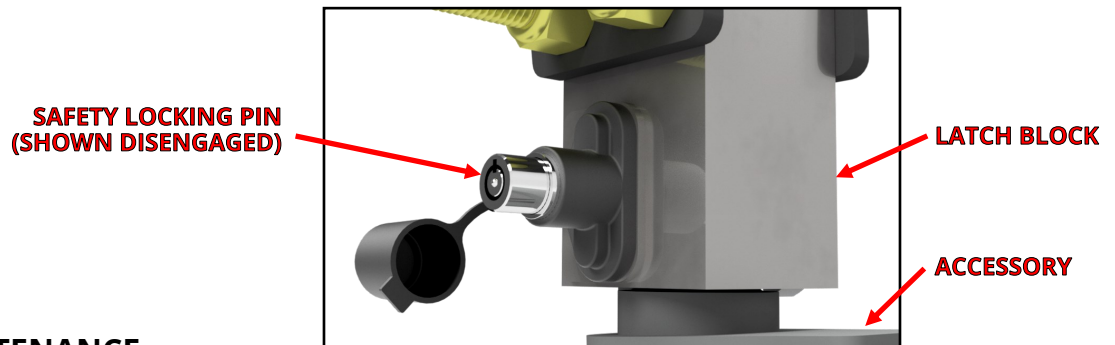

PRODUCT USE AND MAINTENANCE

NOTICE: If the hitch is being installed by a professional, the installer is responsible for training the end user in the use and maintenance of the product.

- **Accessory installation procedure:**
 1. Prepare latching mechanism. Turn handle clockwise if needed.
 2. Firmly insert "post" of accessory into latch block until handle spins counter-clockwise indicating that the accessory is latched.
 3. Always depress the safety locking pin and check that it has fully engaged.
- **Never use any accessory with the safety lock disengaged.** Until the safety locking pin is engaged, the handle is able to turn. A fully engaged safety locking pin is confirmation that the accessory is properly latched into the latch block.
- **Never use the rack receiver for towing.** The rack receiver accessory is only to be used with payload carrying products, such as bike racks or luggage racks.
- **Before each use, give the post of the accessory a light coating of lithium based grease.**
- **Before each use, inspect the hitch to ensure that all bolted connections are secure and that no cracks or damage are present.** Do not tow with the hitch if cracks or damage outside of normal wear is found.
- **Remove the Stealth accessories from the latch block after each use.** Do not leave accessories plugged in for extended periods of time.