



GDI-8123-01 / GDI-8125-01

3 and 5 Person Hybrid Saunas



Owner's Manual

SAUNA IS FOR OUTDOOR USE

GDI-8123-01 - 240V 30AMP Circuit Required For Heater

GDI-8125-01 - 240V 40AMP Circuit Required For Heater

Carefully and thoroughly read this Owner's Manual before using/operating the sauna. We recommend keeping this Owner's Manual for regular review and future reference. Follow your local codes and ordinances. The stove heater power requirements do vary among manufacturer. The stove heater must be installed by a certified licensed electrician per the manufacturer's manual. The stove heater must be installed per the electrical code in your area with reference to the breaker and wire sizes. Models are subject to change.

Thank you for your purchase. As you remove the parts from the boxes, be sure to examine them for damages. If your unit has any damages or missing parts, please contact Golden Designs Inc. See the Warranty section for more information.

A Certified Licensed Electrician will be needed to install the electrical wiring. Due to the heat of the sauna, it is required that copper wire with 90° Celsius rating be used. Aluminum wiring cannot be used in this application. Consult with your electrician regarding the electrical requirements in your area. All wiring must be in accordance with all national, state, and local codes and regulations. Your electrician will supply the needed wiring and connections.

Sauna models without a specific outdoor roofing cannot be placed directly in the weather elements. These models, if placed outdoors, can be placed under a covered structural such as a patio. Before assembling, make sure the surface in which the sauna will be placed on is level/dry and can support the weight of the sauna and its occupants. We recommend a concrete base or wood deck to support the sauna. If you will be placing the sauna directly on the ground, you must use such materials as concrete cinder blocks or other similar supporting structure to prevent the sauna from settling into the ground over time.

For sauna models specifically designed to be outdoors, the wood can withstand the weather elements with proper maintenance. The outdoor model saunas were designed to be placed in the rain and sun. Please note that the natural weathering elements will change the color of the wood over time. For sauna models placed directly in the weather elements, you will have some water seepage. The water seepage will not damage the sauna and usually dries quickly when the sauna is in operation.

The information provided in this Owner's Manual is for informational purposes only and may not be construed as medical advice or instruction. The information is not recommended for any particular treatment and in all cases, it is recommended that you consult with your medical physician before using. This product does not constitute or imply any medical endorsement. The pictures and diagrams shown within this Owner's Manual are representations of this model(s). Actual model may vary.

FOLLOW ALL INSTRUCTIONS AND BE CAUTIOUS OF SAFETY SYMBOLS.
All electrical wiring must be performed by a certified licensed electrician.
Although this manual is a universal manual, the information within this manual is applicable to each sauna.



High Voltage Symbol: Be cautious as there is the presence of a high voltage current that flows through the equipment!



General Caution Symbol: Be cautious as the equipment uses electrical current that can cause serious injury.

ATTENTION

⚠ WARNING

1. Please read this Owner's Manual thoroughly before use. This will allow the user to become familiar with the operation of the control system. Please keep the Owner's Manual available for future reference. If any technical assistance or repairing is needed, please contact the manufacturer.
2. The sauna will need to be installed outdoors. If installed outdoors and over time, water may seep into the sauna room. When not in use and placed outdoors, a rain cover is recommended to cover the sauna room if your model does not come with an actual outdoor roof. Please note that water seepage will not hurt the wood and will usually dry quickly due to the heated environment. If you want to keep the sauna completely dry, you will need to install the sauna under a covered structure.
3. To reduce the risk of electric shock and/or fire, do not expose the control system to direct water contact or rain. Do not open the cover to the control system as there are high tension fittings that can be dangerous. Only dealer authorized qualified technicians should make any needed or necessary repairs at any time.
4. Any repairs, alterations, or modifications to the control system are not authorized unless by an approved repair technician. Any non-authorized repairs, alterations, or modifications can lead to serious injuries and can cause the unit to work outside its intended specification parameters.
5. Any non-authorized repairs, alterations, or modifications will void the warranty.
6. Before connecting the unit to a power source, please make sure that all wires, cords, and connections are connected properly. If there are any concerns, please consult with a certified electrician.
7. Make sure that the sauna is placed in a well-ventilated area. It should not be placed in an area with other thermal-radiating objects. Make sure that the vents will not be obstructed for proper air flow.

8. When the equipment is not going to be used for an extended period of time, you can disconnect the sauna from the power source or turn OFF the dedicated circuit breaker.
9. Allow 30 seconds between turning the control system “On” and “Off”. By allowing 30 seconds between powering the control system “On” and “Off” will prolong the life of the unit.
10. Confirm that you adhere to the correct power requirements of the control system. Connecting the control system to other than the required voltage can damage the control system and possibly cause serious injury. It is very important that the load parameters are consistent with that needed by the control system. Always consult with a certified electrician.
11. Canadian Red Cedar (pertaining only to sauna models constructed of Red Cedar) and its rich aroma can cause an extremely small percentage of the population to have an adverse reaction known as Multiple Chemical Sensitivity (MCS). While this is not a universally recognized disorder in the medical field, certain consumers have an adverse physical reaction to low levels of many common chemicals and cannot tolerate any aromatic oils, shampoos with perfumes infused or certain herbs with natural aromas. However, for the majority of the population, Canadian Red Cedar is the sauna wood of choice.
12. Children must use the sauna under the care of adults and only after consulting with a medical doctor. Never play in or around the sauna. Never put animals into the sauna room.
13. The power cord and plug must be located out of the reach of children and away from any water source. Please consult with a certified electrician for safety concerns.
14. Never insert body parts or any other objects into the heater. Never put any foreign objects on or in the heater. Please follow the heater instructions and safety precautions.
15. Never use or store flammable liquids/gases/objects near or inside the sauna or around/above the heaters.
16. Never store items or objects on top of the sauna.
17. Never use the sauna or heater if the power cord is damaged. Contact Customer Service immediately and do not use the sauna.
18. Never touch the control panel, heater parts, or any electrical parts with wet hands.
19. Never use the sauna in a weather storm.
20. Make sure that the sauna sits on a level surface and the surface can support the weight of the sauna (when filled with users) which can exceed 1000 lbs. A concrete slab, concrete pavers, gravel, cinder blocks, or solid wood deck is always best for outdoor installations. In addition, be sure that the support cradles rest on cinder blocks or other structures so as to prevent sinking/settling into the ground.
21. For every (4) hours of use, the sauna should be shut down for (1) to prevent overheating and premature deterioration of the equipment.

- 22.** Never complete unauthorized repairs on the sauna or the heater.
- 23.** Never use the sauna in combination with alcohol, medication, or drugs.
- 24.** Pregnant women should never use the sauna. Women should also not use the sauna during their menstrual cycle.
- 25.** If you have any medical condition, you must consult with your medical doctor before using the sauna.
- 26.** Be cautious not to over extend yourself after an intense exercise workout by using the sauna. You can let the body cool down for 10 - 20 minutes before entering the sauna. Do not spend more than 40 minutes in the sauna at any one time.
- 27.** Prolonged exposure to high temperatures can cause burns. Stop using the sauna immediately if you experience overheating, dizziness, weakness, sleepiness, or fainting.
- 28.** Consult with your medical doctor before using the sauna if you suffer from diabetes, blood circulation disease, blood pressure issues, heart disease, or obesity.
- 29.** Watch your head when entering and exiting the sauna.
- 30.** Never clean the sauna with chemical-based cleaners or detergents. You can clean the sauna with any non-toxic, water-based cleaners.
- 31.** Make sure the vents are always unobstructed.
- 32.** Being that the sauna will operate in different climates (some areas are colder than others), it is not recommended to use the infrared sauna above 140 degrees Fahrenheit / 60 degrees Celsius and the traditional sauna above 190 degrees Fahrenheit / 88 degrees Celsius.
- 33.** To avoid a hazard, do clean the sauna floor of all perspiration and debris after each sauna session.

TABLE OF CONTENTS

Visual Assembly Diagrams	7
Parts Description	9
Dimensional Diagram	11
Screw Identification	13
Wall Panel Descriptions	15
Main Power Switch Schematic	17
Assembly Instructions	18
Sauna Control Panel	24
Tips for Using Your Sauna	31
Safety Instructions	32
Safeguards for Your Sauna	33
Warranty	35
Warranty Card	37

WARNING: Visually inspect all heaters before assembly to make sure they are not damaged. Any excessive vibrations during transport could cause damage to the heating elements. **DO NOT START** the sauna if damage is detected! Contact your dealer or manufacturer for troubleshooting and replacement parts. The wood is naturally resistant to the weather elements, but the weathering elements can affect the wood over time.

PLEASE NOTE: The pictures and diagrams shown within this owner's manual are representations of this model. Actual models may vary. Design and construction are subject to change. If installed outdoors and over time, water may seep between the gaps of the construction. This would be considered normal. When not in use and placed outdoors, a water proof cover is recommended to cover the sauna room.

CAUTION: Exit Sauna Immediately If You Feel Dizzy, Sleepy, Or Any Discomfort.

PLEASE READ INSTRUCTIONS THOROUGHLY BEFORE ASSEMBLY

Visual Assembly Diagram

GDI-8123-01

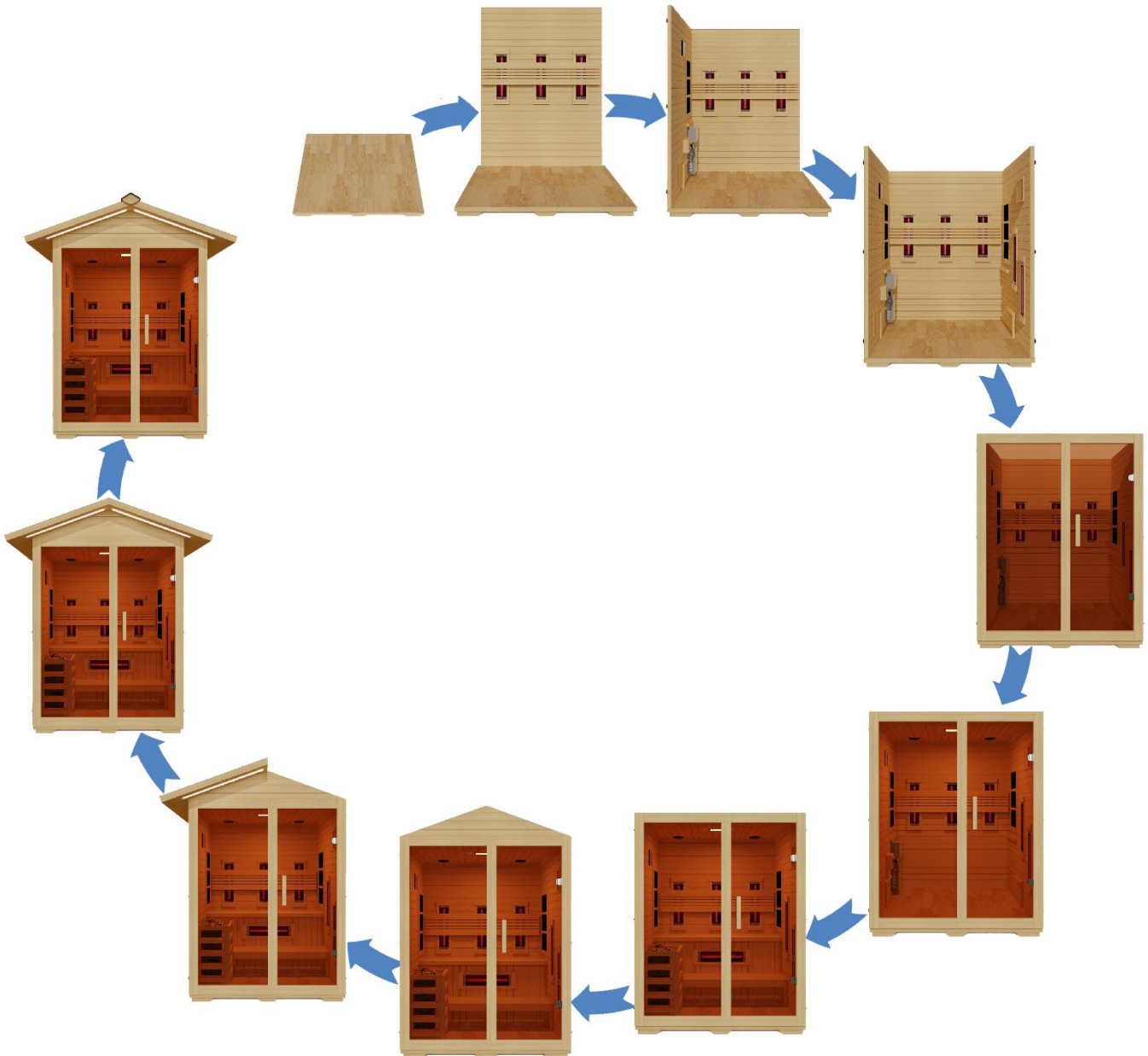

***THE ABOVE ASSEMBLY DIAGRAM IS FOR A QUICK REFERENCE VISUAL GUIDE ONLY. ALL SAUNA MODELS MAY NOT BE SHOWN. PARTS AND ACCESSORIES DO VARY AND ARE SUBJECT TO CHANGE.**

PLEASE READ INSTRUCTIONS THOROUGHLY BEFORE ASSEMBLY

Visual Assembly Diagram

GDI-8125-01

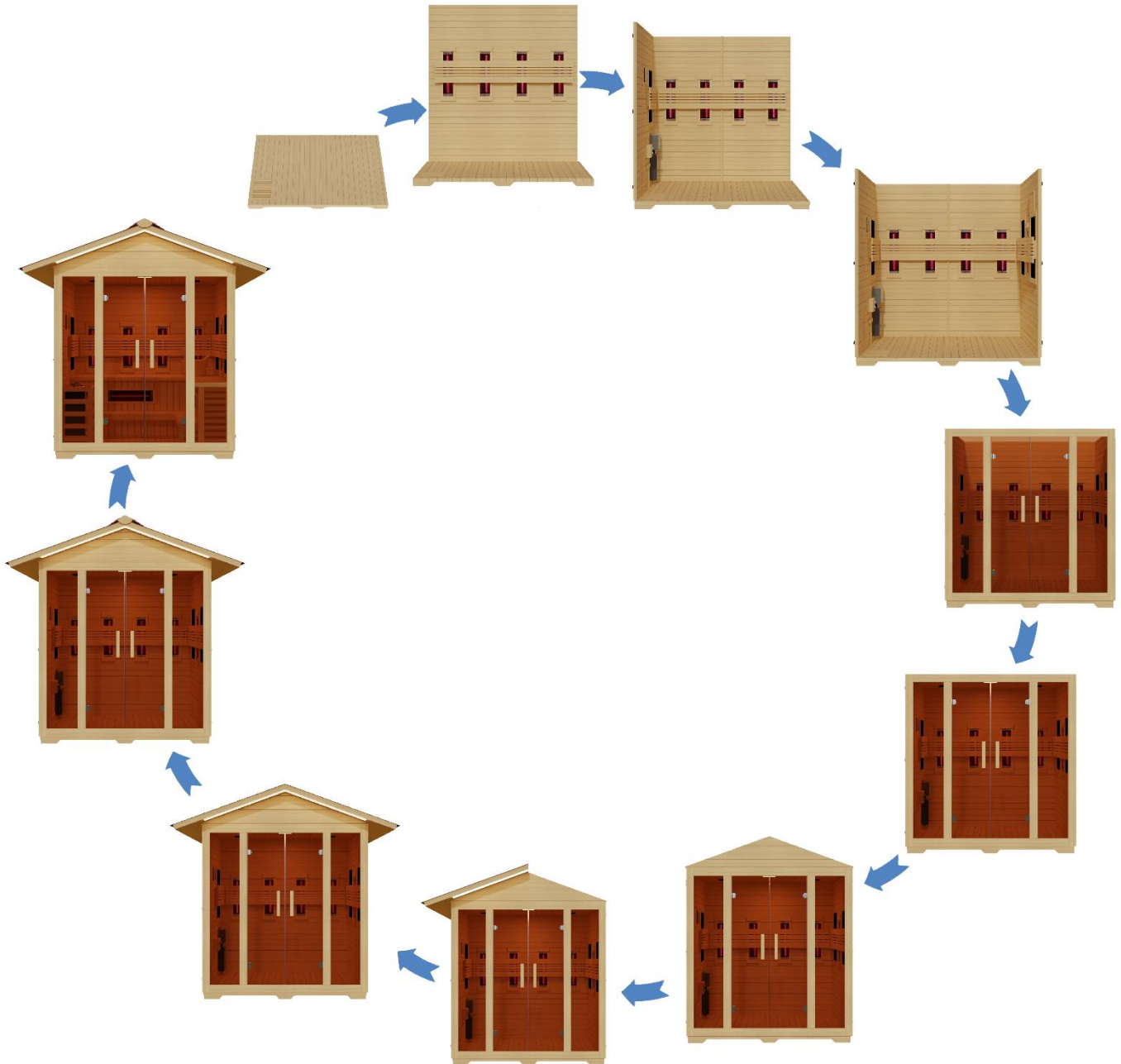

***THE ABOVE ASSEMBLY DIAGRAM IS FOR A QUICK REFERENCE VISUAL GUIDE ONLY. ALL SAUNA MODELS MAY NOT BE SHOWN. PARTS AND ACCESSORIES DO VARY AND ARE SUBJECT TO CHANGE.**

PLEASE READ INSTRUCTIONS THOROUGHLY BEFORE ASSEMBLY

PARTS DESCRIPTION

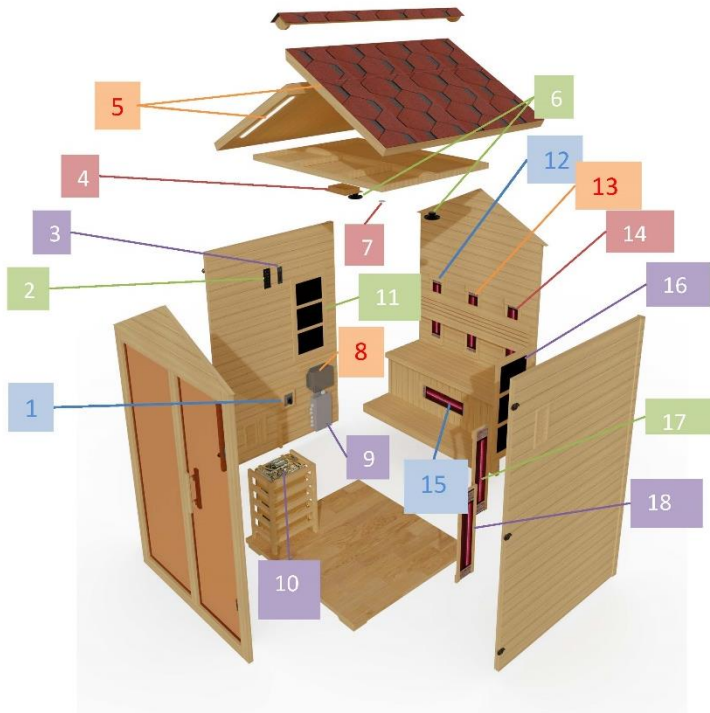

GDI-8123-01			
Electronic components			
No.	Name	No.	Name
1	Transfer Switch	2	Control panel for lights
3	Control panel for heaters	4	color light
5	Roof lights	6	Speakers
7	Temperature sensor	8	Power supply for lights
9	Power supply for heaters	10	Stove

Power Layout			
Location	No.	Dimension	Power
Left side wall	11	750*400mm	300W
	12	NIR Heater	400W
Rear wall	13	NIR Heater	400W
	14	NIR Heater	400W
	15	NIR Heater	400W
Right side wall	16	750*400mm	300W
	17	NIR Heater	400W
	18	NIR Heater	400W
TOTAL			3000W

***THE ABOVE ASSEMBLY DIAGRAM IS FOR A QUICK REFERENCE VISUAL GUIDE ONLY. ALL SAUNA MODELS MAY NOT BE SHOWN. PARTS AND ACCESSORIES DO VARY AND ARE SUBJECT TO CHANGE.**

PLEASE READ INSTRUCTIONS THOROUGHLY BEFORE ASSEMBLY

PARTS DESCRIPTION

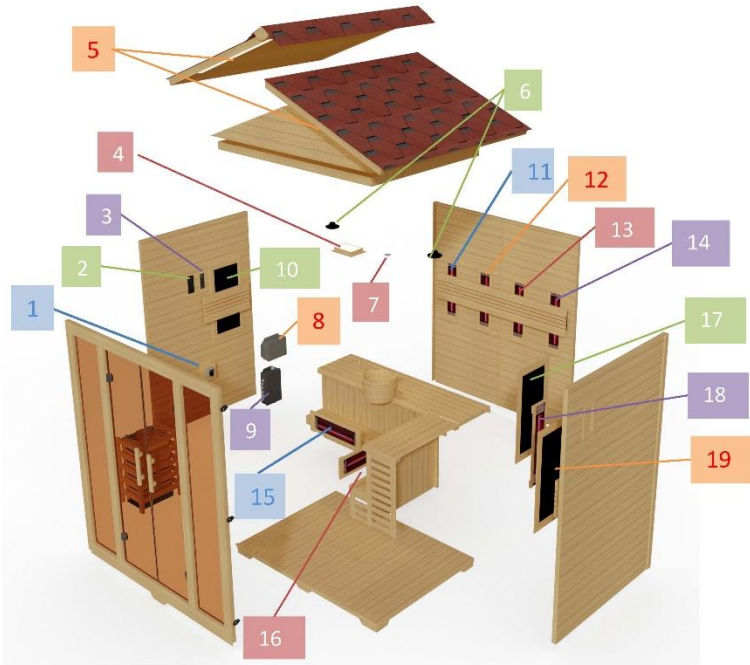

GDI-8125-01

Electronic components			
No.	Name	No.	Name
1	Transfer Switch	2	Control panel for lights
3	Control panel for heaters	4	color light
5	Roof lights	6	Speakers
7	Temperature sensor	8	Power supply for lights
9	Power supply for heaters		

Power Layout			
Location	No.	Dimension	Power
Left side wall	10	750*400mm	300W
Rear wall	11	NIR Heater	400W
	12	NIR Heater	400W
	13	NIR Heater	400W
	14	NIR Heater	400W
Bench heater	15	NIR Heater	400W
	16	NIR Heater	400W
Right side wall	17	750*400mm	300W
	18	NIR Heater	400W
	19	750*400mm	300W
TOTAL			3700W

***THE ABOVE ASSEMBLY DIAGRAM IS FOR A QUICK REFERENCE VISUAL GUIDE ONLY. ALL SAUNA MODELS MAY NOT BE SHOWN. PARTS AND ACCESSORIES DO VARY AND ARE SUBJECT TO CHANGE.**

DIMENSIONAL DIAGRAM

GDI-8123-01

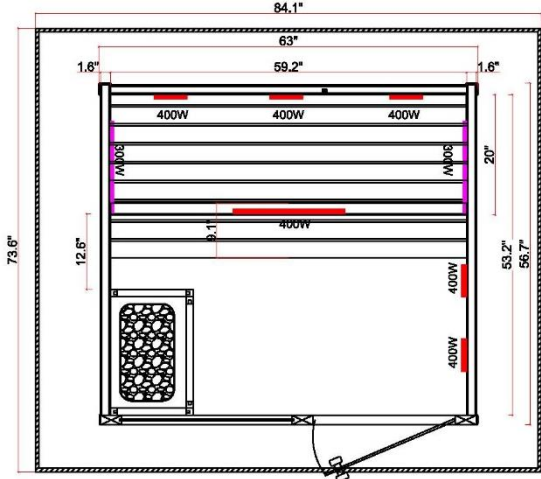

Total power:3000W
Vertical Section View

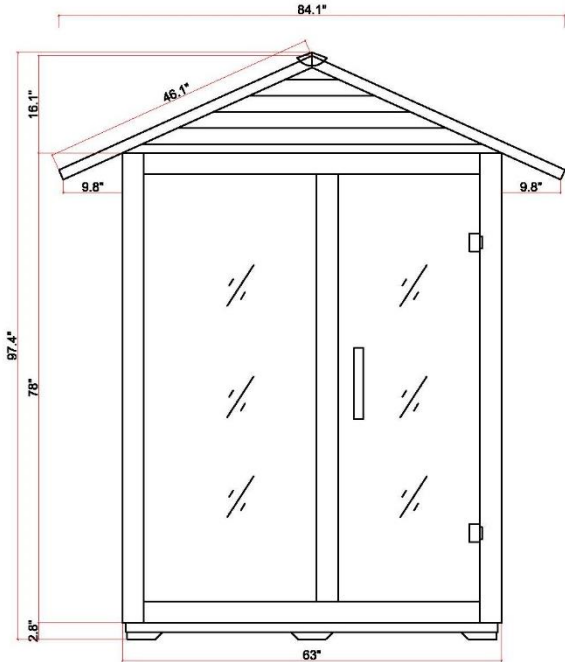

Front Panel Outside View

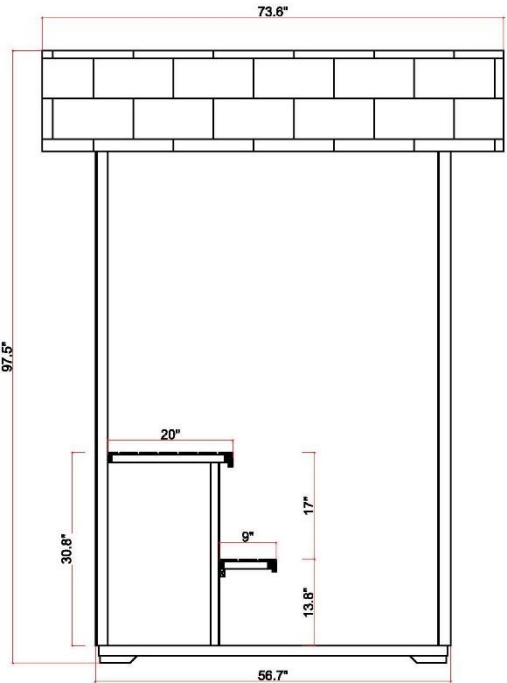

Side Panel Inside View

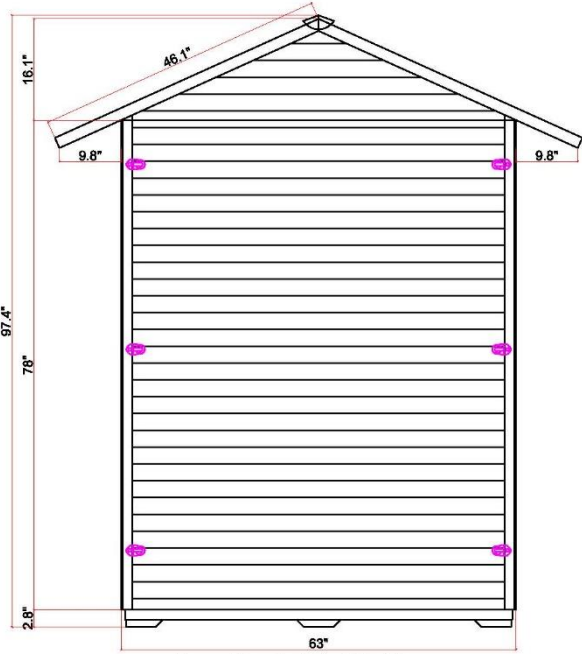

Rear Panel Outside View

DIMENSIONAL DIAGRAM

GDI-8125-01

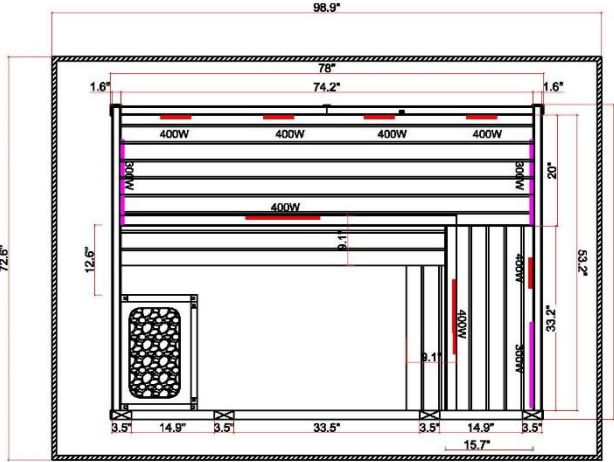

Total power:3700W
Vertical Section View

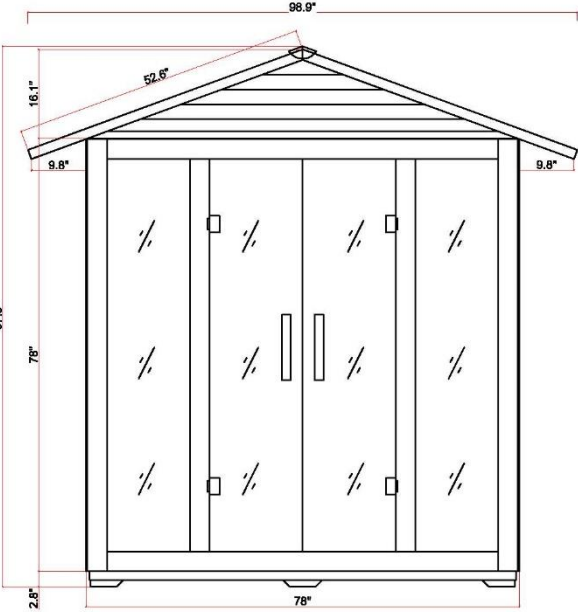

Front Panel Outside View

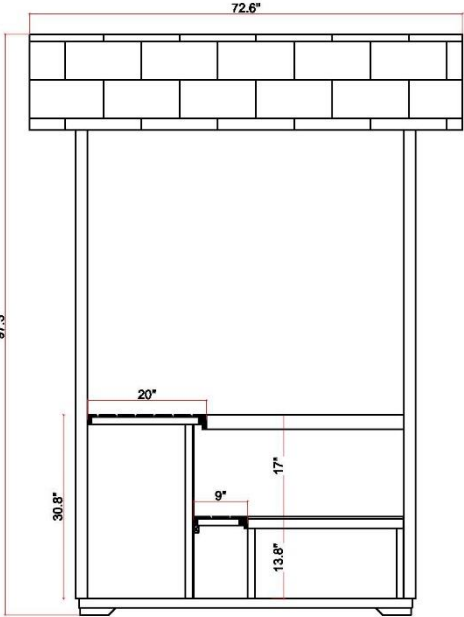

Side Panel Inside View

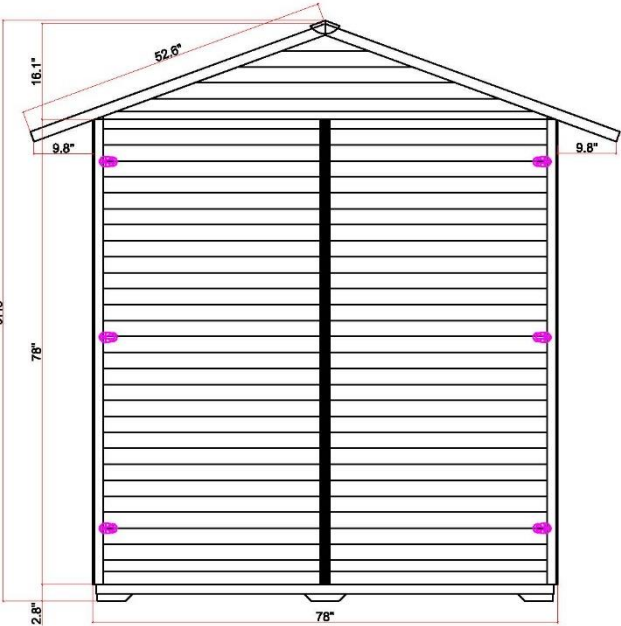

Rear Panel Outside View

Screw Identification Chart



SCREW IDENTIFICATION AND LOCATION CHART:

MODEL: GDI-8123-01		
LOCATION	SPECS	USAGE
TOP COVER	3.5x35mm(stainless)	4
OUTSIDE ROOF PANEL(RIDGE TILE)	3.5x40mm(wood screw-gold color)	8
INSIDE ROOF PANEL	5x40mm(wood screw-gold color)	8
TRIANGULAR PLATE	5x50mm(wood screw-gold color)	4
HOURGLASS	3x18mm(wood screw-gold color)	2
WOOD FRAME FOR STOVE	3.5x40mm(wood screw-gold color)	10
BACKREST	3.5x40mm(wood screw-gold color)	4
BENCH	3.5x40mm(wood screw-gold color)	2
BENCH SUPPORT	3.5x40mm(wood screw-gold color)	6
STEP	3.5x40mm(wood screw-gold color)	4

Screw Identification Chart



SCREW IDENTIFICATION AND LOCATION CHART:

MODEL: GDI-8125-01		
LOCATION	SPECS	USAGE
TOP COVER	3.5x35mm(stainless)	4
OUTSIDE ROOF PANEL(RIDGE TILE)	3.5x40mm(wood screw-gold color)	12
INSIDE ROOF PANEL	5x40mm(wood screw-gold color)	8
TRIANGULAR PLATE	5x50mm(wood screw-gold color)	4
HOURGLASS	3x18mm(wood screw-gold color)	2
WOOD FRAME FOR STOVE	3.5x40mm(wood screw-gold color)	10
BACKREST	3.5x40mm(wood screw-gold color)	6
BENCH	3.5x40mm(wood screw-gold color)	4
BENCH SUPPORT	3.5x40mm(wood screw-gold color)	22
STEP	3.5x40mm(wood screw-gold color)	8

Wall Panel Descriptions for GDI-8123-01

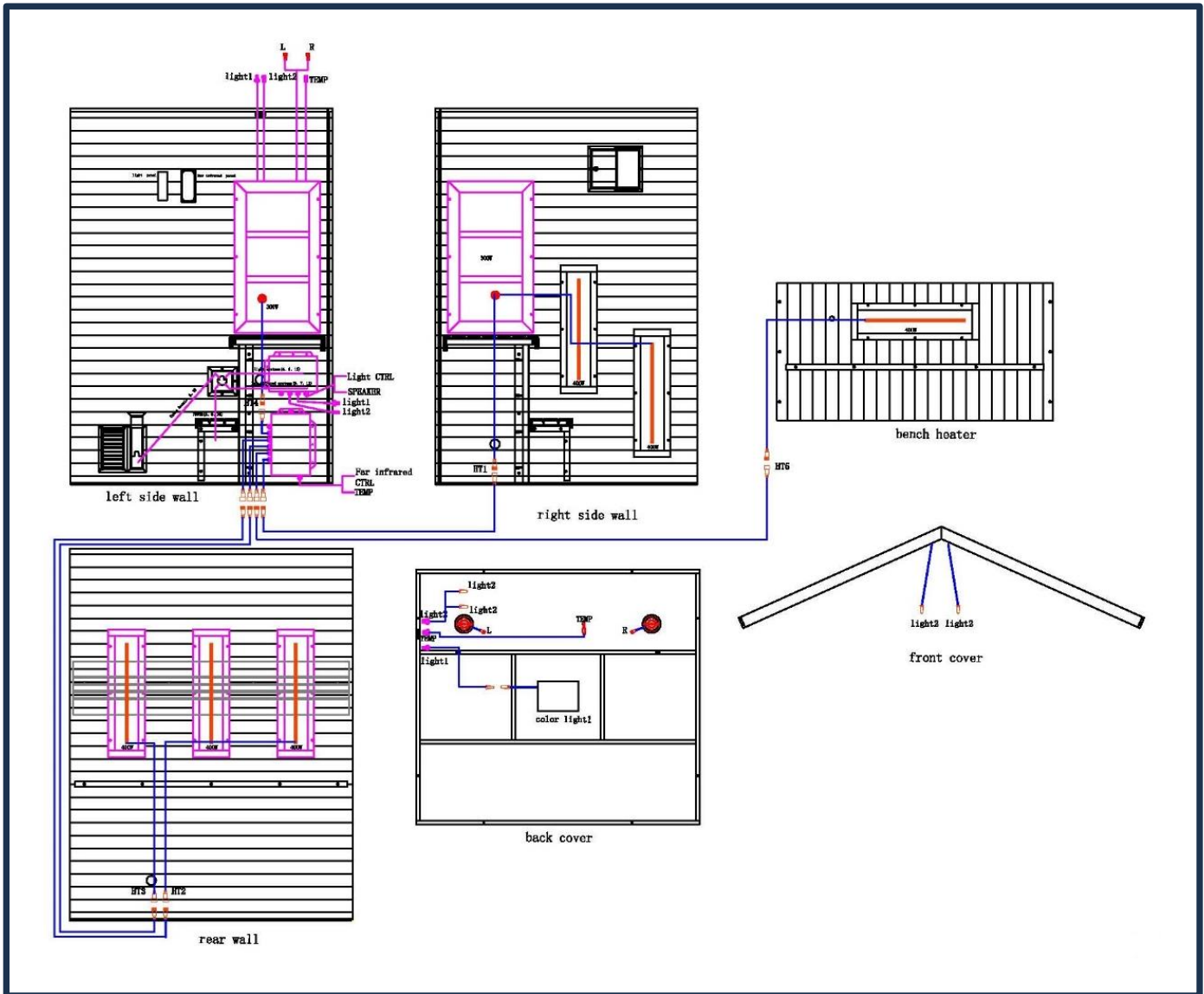

NOTE: The pictures and diagrams shown above/below are for representational purposes only. Actual model may vary. Parts subject to change.

Wall Panel Descriptions for GDI-8125-01

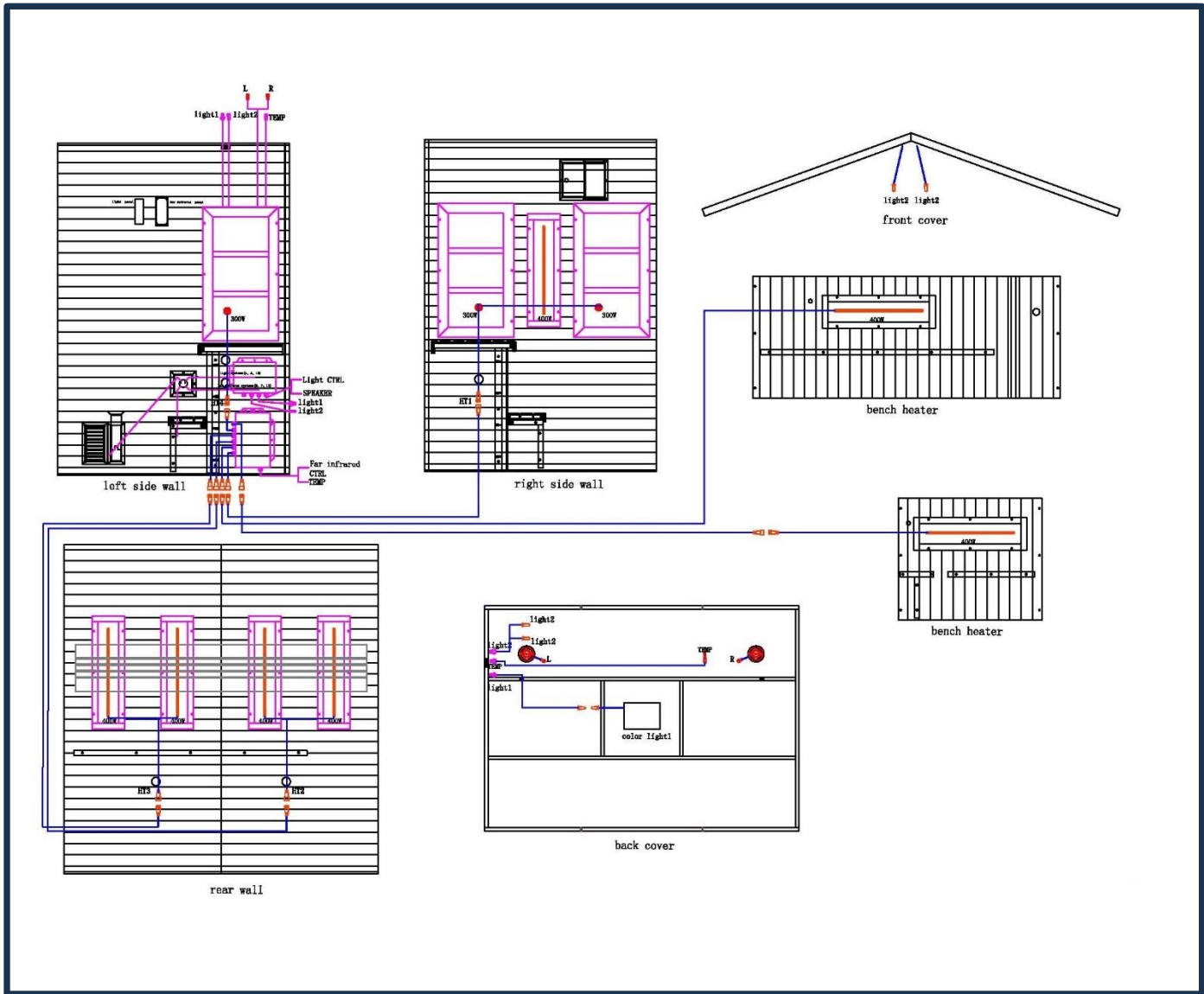

NOTE: The pictures and diagrams shown above/below are for representational purposes only. Actual model may vary. Parts subject to change.

PLEASE READ INSTRUCTIONS THOROUGHLY BEFORE ASSEMBLY

Main Power Switch Schematic

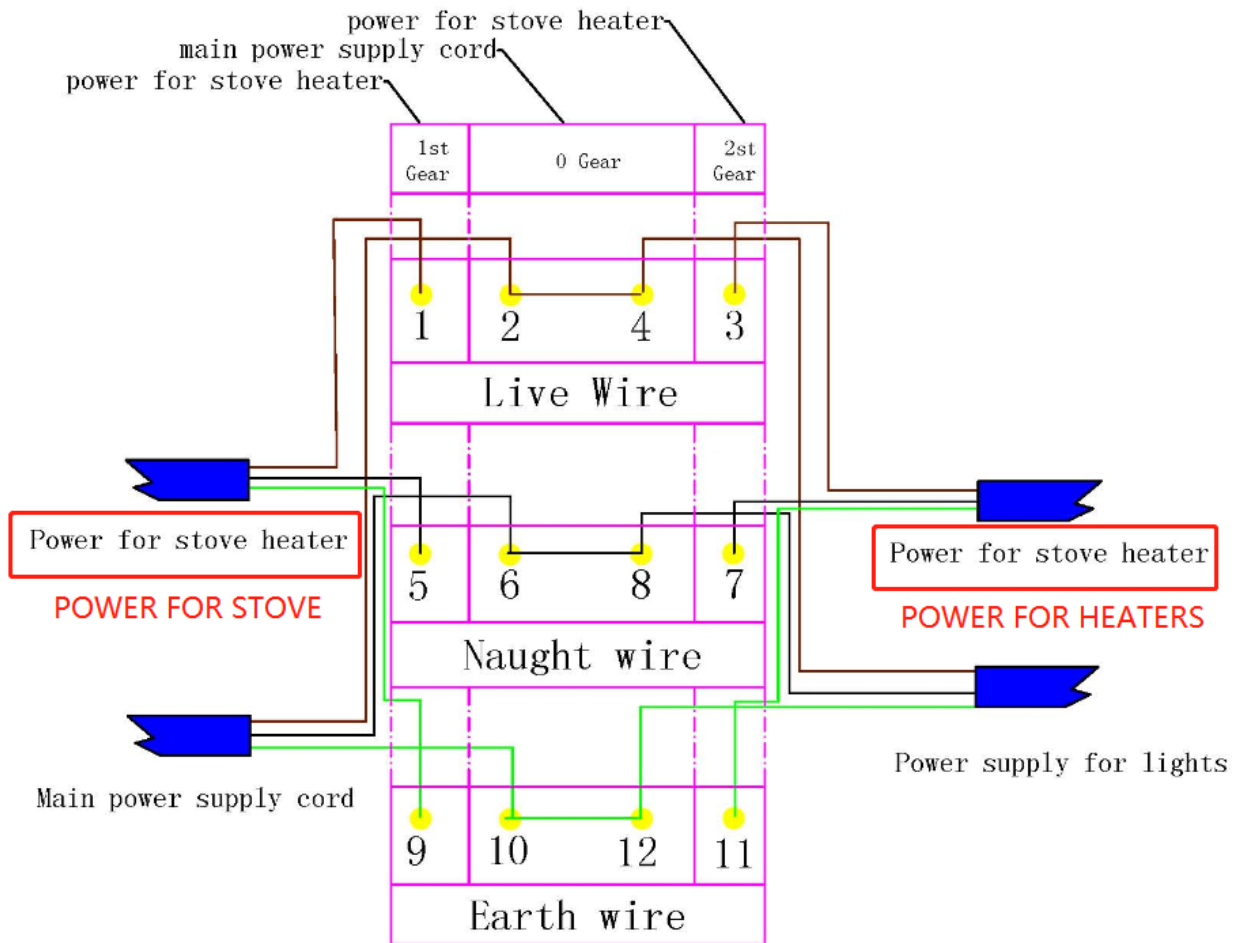

***Wiring will be supplied by your certified electrician.**

***THE ABOVE ASSEMBLY DIAGRAM IS FOR A QUICK REFERENCE VISUAL GUIDE ONLY. ALL SAUNA MODELS MAY NOT BE SHOWN. PARTS AND ACCESSORIES DO VARY AND ARE SUBJECT TO CHANGE.**

Assembly Instructions (GDI-8123-01 used in assembly instructions)

A. Choose a good location to install the sauna

1. The location must be dry, leveled, and away from any source of water.
2. The heater must be installed by a certified electrician.
3. Three adults are required for installation.
4. Sauna Panels: FLOOR PANEL – LEFT SIDE WALL PANEL – REAR WALL PANEL – RIGHT SIDE WALL PANEL – FRONT WALL PANEL – INTERIOR ROOF PANEL – BENCHES/BENCH SUPPORT PANEL/BACKREST/STEP – EXTERIOR ROOF PANEL
5. Tools Required: Battery Operated Screwdriver or Hand-Held Philips Screwdriver, Rubber Mallet, and (2) Ladders.

B. Installing the FLOOR PANEL and REAR WALL PANEL

1. Place the FLOOR PANEL in the chosen location for the sauna room.
Please note that the wood pattern on the floor runs front-to-back. You will need to have enough space to navigate around the sauna room while assembling. Next, place the REAR WALL PANEL up and onto the FLOOR PANEL. One adult will need to hold the REAR WALL PANEL in place.
Please note that if the BACKREST is not already installed, it will be installed in a later step. (see Figure 1)

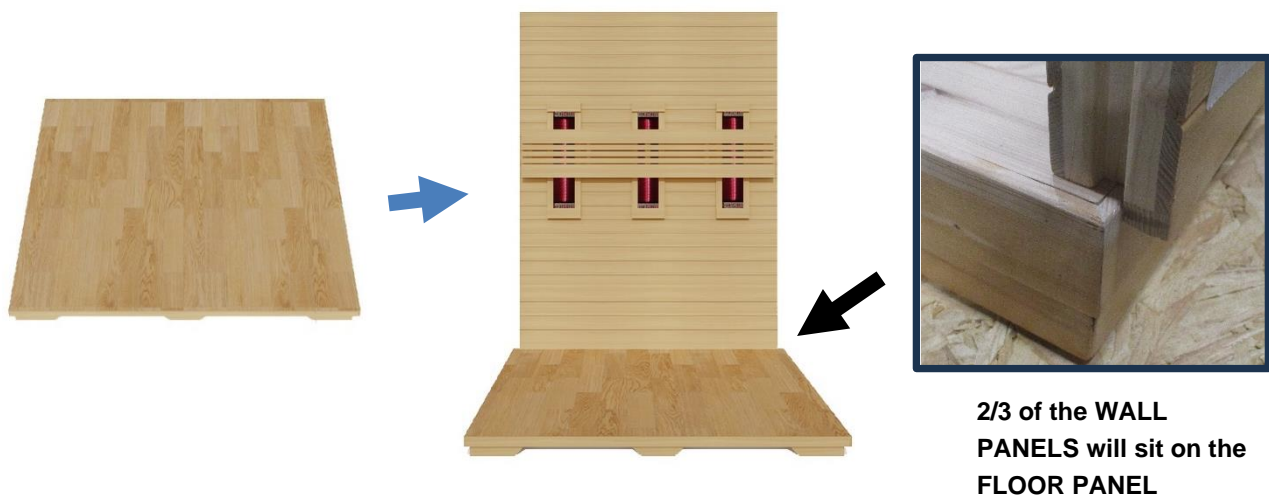

Figure 1

C. Installing the LEFT SIDE WALL PANEL

1. Place the LEFT SIDE WALL PANEL up and onto the FLOOR PANEL and next to the REAR WALL PANEL. Use the buckles to latch the two wall panels together. (see Figure 2)

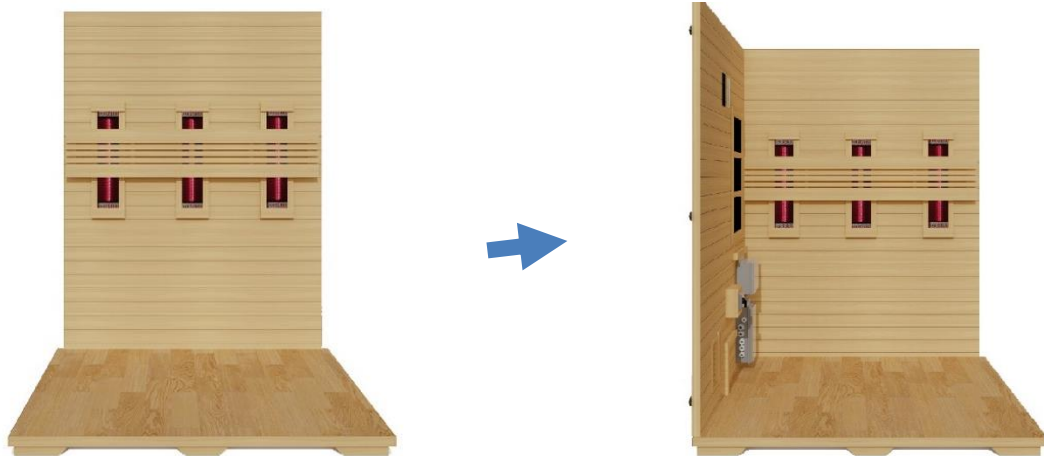

Figure 2

D. Installing the RIGHT SIDE WALL PANEL

1. Place the RIGHT SIDE WALL PANEL up and onto the FLOOR PANEL and next to the REAR WALL PANEL. Use the buckles to latch the two wall panels together. (see Figure 3)

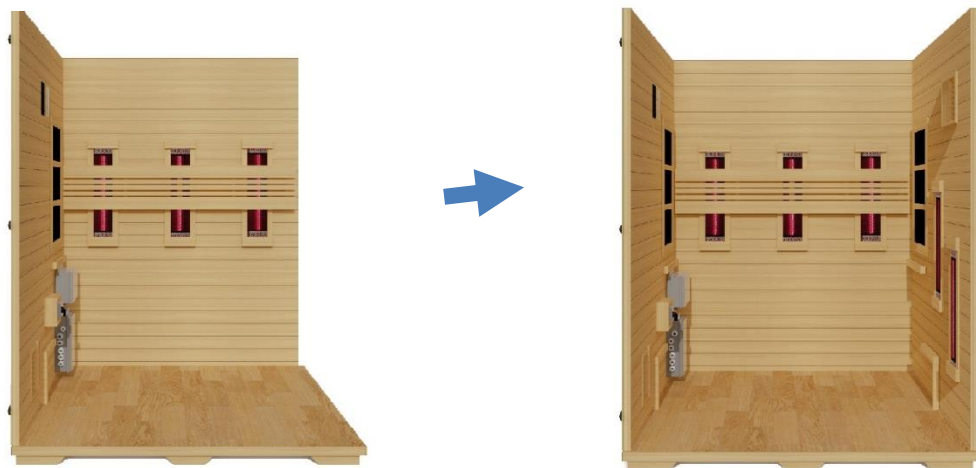

Figure 3

E. Installing the FRONT WALL PANEL

1. Now it is time to install the FRONT WALL PANEL. Place the FRONT WALL PANEL up and onto the FLOOR PANEL next to the RIGHT SIDE WALL PANEL and LEFT SIDE WALL PANEL. Use the buckles to latch the wall panels together. (see Figure 4)

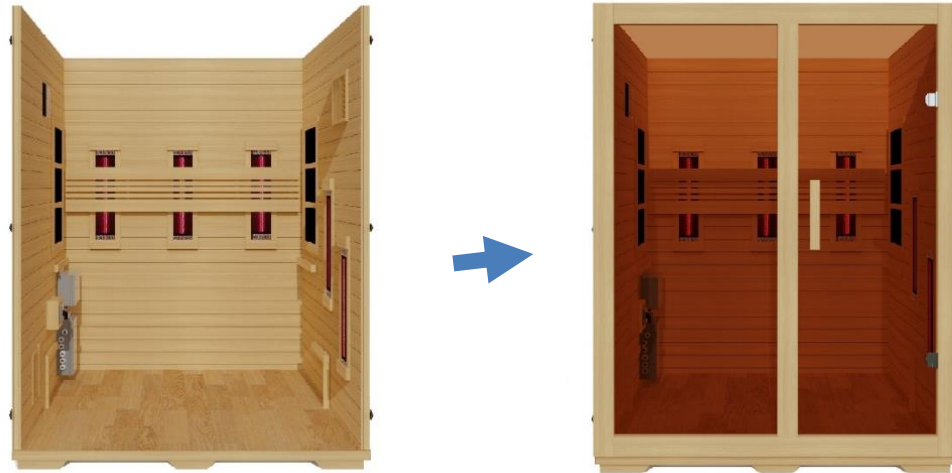

Figure 4

F. Installing the INNER ROOF PANEL

1. Locate the INNER ROOF PANEL. It will need to be lifted up and over the wall panels and placed into position resting on the supports of the wall panels. Use the provided screws and predrilled holes to screw down the INNER ROOF PANEL to the FRONT WALL PANEL and REAR WALL PANEL. (see Figure 5)

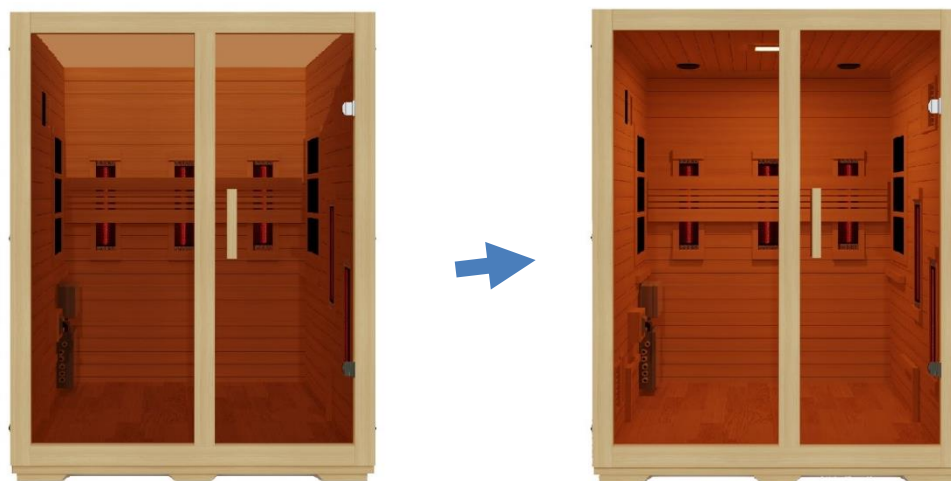

Figure 5

G. Installing the BENCH SUPPORT, BENCH, BACKREST, and STEP

1. Locate the BENCH SUPPORT and slide it down the vertical channels on the side wall panels. Use the provided screws to screw the BENCH SUPPORT down to the vertical channels on the side wall panels. Next, the BENCH can slide horizontally over the BENCH SUPPORT PANEL. Use the provided screws to screw the BENCH down and BACKREST (if not already installed) to the REAR WALL PANEL. The BACKREST should sit about 9 inches above the bench. For installing the STEP, locate the lower horizontal wood slat on the side wall panels. Next, the STEP can slide horizontally over the wood slats. Be sure the STEP is all the way back when you screw it down as it will support the BENCH SUPPORT so that it does not move. Use the provide screws to screw down the STEP to the horizontal wood slats. **Please note that the stove and stove wood guard will be installed at a later time.** (see Figure 6)



Figure 6

H. Installing the EXTERIOR ROOF PANEL

1. Locate the two triangular OUTER ROOF PANEL supports. Use the provided screws to screw the triangular OUTER ROOF PANEL supports to the FRONT WALL PANEL and REAR WALL PANEL. (see Figure 7)



Figure 7

The triangular OUTER ROOF PANEL for the rear wall has a flat edge



The triangular Outer Roof Panel for the front wall has an angled edge



2. It is now time to install the OUTER ROOF PANELS. The OUTER ROOF PANELS will have the asphalt shingles (facing outward). Locate the LEFT SIDE OUTER ROOF PANEL and note that the ROOF LIGHTS will be at the front of the sauna when installing it over the triangular supports. Do not screw down until the RIGHT SIDE OUTER ROOF PANEL has been installed. There will be a wood trim around three sides of the inside of the OUTER ROOF PANELS that fit inside the two triangular supports and LEFT SIDE WALL PANEL and RIGHT SIDE WALL PANEL. Once both of the OUTER ROOF PANELS have been installed, you will need to place a ladder inside the sauna room to enter the attic in order to use the provided screws to secure the OUTER ROOF PANELS to the triangular OUTER ROOF PANEL supports using the predrilled holes and screws. You can use the provided screws to screw the two OUTER ROOF PANELS together and down to the triangular supports. (see Figure 8)



Figure 8

3. Locate the third section of the OUTER ROOF PANEL, the RIDGE TILE. Use the provided screws to mount the RIDGE TILE to the OUTER ROOF PANELS toward the ends. There are no predrilled holes. (see Figure 9)



Figure 9

Lift the roofing tiles at the end to screw down the RIDGE TILE. Use 2 screws at each end.

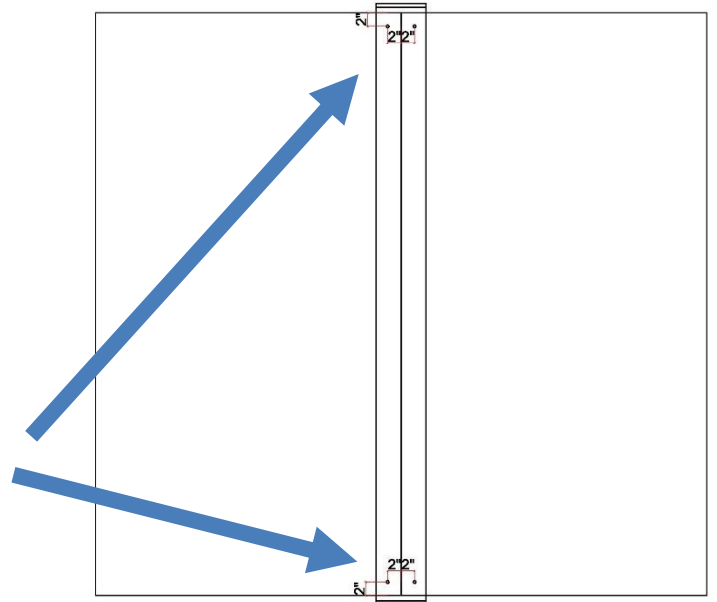

I. Installing the DOOR HANDLE

1. If the interior and exterior DOOR HANDLE is screwed together, you will need to unscrew in order to attach the DOOR HANDLE to the glass door. Make sure when installing the DOOR HANDLE that you do not over tighten the screws.

ASSEMBLY COMPLETED

SAUNA CONTROL PANEL - GENERAL INTRODUCTION

Please note that you can either have the stove heater operating or the Infrared heaters operating, but not both at the same time. You can turn the Main Power Switch knob to the left or right to select either the stove heater or the Infrared heaters to operate. If you switch the Main Power Switch knob to the “0”, then neither the stove heater or Infrared heaters will have power. See page 17 for connecting the Main Power Switch to power.



1. Description of Functions of the Sauna's Control Panel

Functions	
Touch Key technology	√
Bluetooth	√
Chromotherapy Lighting	√
Exterior Accent Lighting	√
Time/Temperature Adjustment	√

2. Control System Specifications

- A. Rated Voltage: AC100V-AC240V
- B. Rated Power: 50Hz/60Hz
- C. Touch Key technology

3. Control Panels:

Sauna Control Panel

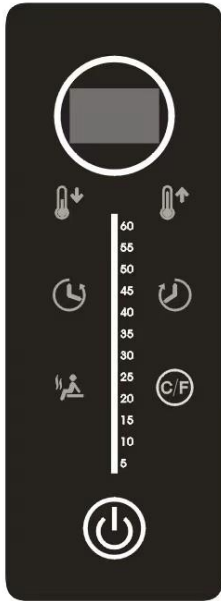

Light/BT Control Panel



CONTROL PANEL OPERATION – Sauna Control Panel

1. First and to operate the Infrared sauna, be sure that the main power switch is turned to "2". To provide power to the stove heater, the main power switch will need to be turned to "1". To turn the power OFF, the main power switch will need to be turned to "0".



Power to Infrared heaters



Power to stove heater



Power turned OFF

- Once the main power switch is turned to “2”, the power button on the sauna’s control panel will become illuminated (red). You will need to press the sauna’s control panel power button for 5 seconds or more until you hear a beep and the sauna’s control panel turns ON. The LED will now be displayed. You can press the sauna’s control panel button again to turn the sauna’s control panel OFF. The sauna’s control panel power button will return to red.



Sauna's Control Panel is OFF
(power button is red)

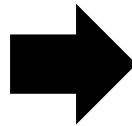

Sauna's Control Panel is ON
(control panel illuminated)

- To turn on the Infrared heaters, press the indicated button below. This button will change from “red” to “green”. If you press this button again, the Infrared heaters will turn OFF and the button will return to “red”. Please note that the BENCH SUPPORT panel has a NIR heater that can be turned ON/OFF. To turn it ON, press the button to the “I” position. To turn it OFF, press the button to the “O” position.

Before pressing to come ON, the button is red. After pressing, the button is green indicating the Infrared heaters are ON.



4. To adjust the timer, see the image below. You will press the clock button on either the left side or the right side. The left side adjusts the timer to decrease the time. The right side adjusts the timer to increase the time.



5. To adjust the temperature, see the image below. You will press the thermometer button on either the left side or the right side. The left side adjusts the temperature to decrease the temperature. The right side adjusts the temperature to increase the temperature.



6. To change the temperature reading between Celsius and Fahrenheit, you can press the C/F button for a few seconds until you hear the control panel beep. Once you set this setting, it will become the default setting.



7. Please note that when you are using the stove heater, you do want to turn OFF the Sauna Control Panel and switch the Main Power Switch to “1”. The Sauna Control Panel will no longer have any illumination.



Sauna Control Panel is Illuminated



Only Power Button is Illuminated



Turn Main Power Switch to “1” for Stove Heater



Sauna Control Panel has no Illumination

CONTROL PANEL OPERATION – Light/BT Control Panel

1. After the sauna has power, there will be no change on the Light/BT Control Panel until you press the power button. Please note that the Light/BT Control Panel is operable when the Infrared heaters are ON or when the Stove heater is ON. When the power button is pressed, you will see (4) lines displayed.



2. On the Light/BT Control Panel, you will see a light bulb icon. This button operates the interior color light. Pressing the button turns the interior color light ON/OFF.



3. On the Light/BT Control Panel and to the right of the light bulb icon, you will find the button for the roof lights. Pressing the button turns the roof lights ON/OFF.



4. Press the BT icon button to enable Bluetooth and the screen will display “bLU”. Next, you can search your device to pair with the sauna. Once paired, you will hear a musical prompt. Please note that no password is needed during the Bluetooth pairing. Press the “TUN-“ and “TUN+” to select a song. If you would like to listen to the radio, you can select the ”FM” button. Use the “TUN-“ and “TUN+” to scroll through the radio stations. Press the “VOL-“ and “VOL+” to adjust the volume.

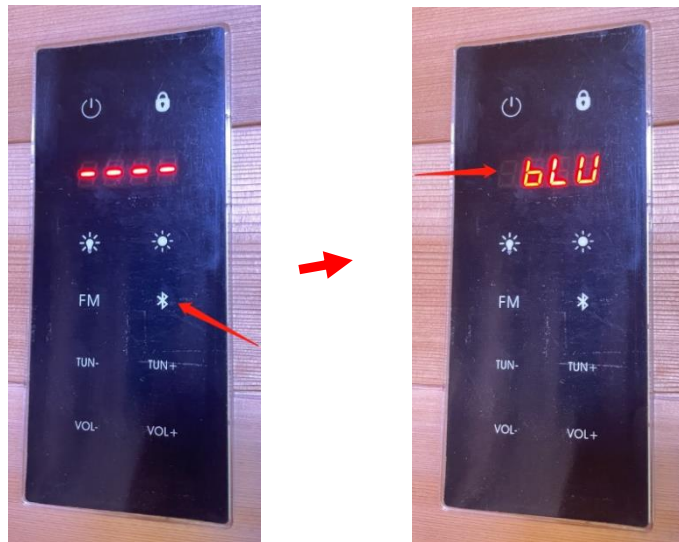

5. If the user does not press any buttons for longer than 3 minutes, the control panel will “lock” as a safety feature. When pressing any buttons on the control panel after the 3 minutes, the screen will display “LOC”. To unlock the control panel, press and hold the “” button.

CAUTION: Exit sauna immediately if you feel dizzy, sleepy, or any discomfort.

Tips for using Your Sauna

- 1) If you take a hot/warm shower or bath before using your sauna, you may perspire more and experience more comfort.
- 2) Drink water prior to, during, and after your sauna session to replenish body fluids.
- 3) The ventilation vent is installed on the sauna and should never be obstructed.
- 4) You can use 2 towels during your sauna session. Fold one of the towels several times and place it on the bench. This towel will absorb some of your perspiration while adding comfort as you sit on the bench. Use a second towel to wipe perspiration from your body from time to time.
- 5) This is a non-commercial sauna. For every four hours ON, the sauna must be turned OFF for one hour to cool down.
- 6) At the first sign of a cold or flu, increasing your sauna sessions may be beneficial in boosting your immune system and decreasing the reproductive rate of viruses.
- 7) To help relieve sore and tense muscles, massage the affected areas during your sauna session.
- 8) The peaceful and relaxed state rendered by a sauna session may help you to sleep easier and deeper.
- 9) To protect the user from coming into contact with the heater, be sure to install the heater wood guard.
- 10) After the sauna session is over, do not jump into the shower or bath immediately. Because your body was heated up during the sauna session, it will continue to perspire even after you exit the sauna room. Sit in the sauna with the door open slightly and let your body cool down. Once your body has cooled down and you feel comfortable, you can exit the sauna. After about twenty minutes and when your body has completely cooled down, you can take a shower to rinse the perspiration off your body.
- 11) To avoid a hazard, do clean the sauna floor of all perspiration and debris after each sauna session.

Safety Instructions

- 1.) Read and follow all instructions carefully before using the sauna.
- 2.) When installing and using the electrical equipment, safety precautions should always be followed.
- 3.) To reduce the risk of injury, do not allow children to use the sauna unless they are directed by a medical doctor and are closely supervised at all times by an adult.
- 4.) Do not use the sauna immediately following strenuous exercises. Wait at least 30 minutes to allow the body to cool down completely.
- 5.) Pregnant or possibly pregnant women should contact their physician prior to using the sauna. Excessive temperature has a high potential for causing fetal damage during pregnancy.
- 6.) **Hyperthermia Danger:** the normal body temperature can't rise above 39°C (103°F). Symptoms of excessive hyperthermia include dizziness, lethargy, drowsiness, and fainting. The effects of excessive hyperthermia may include failure to perceive heat, physical inability to exit sauna, unawareness of impending hazard, unconsciousness and fetal damage in pregnant women. Hyperthermia could make your body's core temperature rise. Setting desired temperature to an excessively high temperature is not recommended.
- 7.) The use of alcohol, drugs, or medications prior to or during the sauna session may lead to unconsciousness and/or other harmful physical injuries.
- 8.) Persons suffering from obesity or with a medical history of heart disease, low or high blood pressure, circulatory system problems, or diabetes should consult a physician prior to using the sauna.
- 9.) Persons using medications should consult a physician before using the sauna. Some medications may induce drowsiness while others may affect the heart rate, blood pressure, and/or blood circulation.
- 10) Exercise care before and after sauna use.
- 11) Never sleep inside the sauna.
- 12) Do not use any type of cleaning agents on the interior of the sauna. Only wipe down with a cloth and water.
- 13) Do not stack or store any object on top or inside the sauna.
- 14) If the heater cord becomes damaged, it must be replaced immediately by a certified electrician. If you find the power cord is too hot or that the electrical equipment may be experiencing technical problems, please contact the manufacturer of the heater or its agent immediately to avoid hazardous conditions.
- 15) Do not use the sauna during an electrical storm to avoid risk of shock.
- 16) Do not touch the glass door hinges during sauna use as they become very hot to the

touch.

- 17) Your hands must be dry and free of moisture before plugging and unplugging cords and wiring harnesses. Never operate the sauna with wet hands or wet feet to avoid risk of electric shock. Never touch the metal prongs of the plug.
- 18) Do not attempt to make any repairs yourself without contacting the manufacturer first. If a problem occurs with the sauna, please contact seller, distributor, or the manufacturer to avoid safety risks. Unauthorized repair attempts will void the manufacturer's warranty.
- 19) Please make sure the supplied power meets the specifications required. Failure to meet the requirements may cause safety risks.
- 20) Do not attempt to touch any electrical parts or make repairs on your own when using the sauna.
- 21) Do not bump, hit, or break the heater as it may cause an electrical short and pose a safety risk.
- 22) Do not make any modifications to the sauna, the sauna structure, or the sauna components.
- 23) Prior to each sauna session, the sauna room is to be inspected for correct operation. If for any reason your sauna room does not seem to be operating properly, discontinue use and contact the manufacturer.
- 24) Do not use the sauna if you are allergic to Infrared heat or heat in general.

Safeguards For Your Sauna

1. Do not install the sauna near an open water source.
2. Do not use liquid cleaners or aerosol cleansers inside the sauna. Make sure the power source is off before cleaning. Use plain water and a soft cloth for cleaning.
3. The power cord should be routed so that it is not walked on or pinched by any object that may be placed against it.
4. When replacement parts are required, be sure they meet the specified requirements of the manufacturer. Unauthorized substitutes may result in fire, electric shock, or other hazardous conditions. After any repairs, please ask the service technician to perform safety checks to determine that your sauna is working properly.
5. Do not use any wall receptacle adapter or extension cords. The heater must be hardwired by a certified electrician. Make sure the electrical cord is not crushed or pinched.
6. For sauna rooms with exterior wood finishes, you will need to maintain the exterior finish. **Never use stain on the interior of the sauna as it must remain all natural.**

Consult the stain manufacturer for any off-gassing concerns. Please note that the cedar wood does start turning grey after approximately 1 – 2 years if the wood is not maintained with a UV protectant.

7. To clean the interior, you can vacuum and sweep down the floors. Use water and a non-toxic cleaner with a damp cloth to wipe down the entire sauna including the benches and walls. For cleaning the heater and stones, please refer to the manufacturer's instructions. Improper use or placement of stones within the heater can result in improper performance of the heater and hazardous conditions. Please note that the heater must be OFF and covered when cleaning the interior of the sauna so not to damage any of the components of the heater, especially if you hose down the interior of the barrel sauna.

Limited Lifetime Warranty

***Limited Lifetime Warranty:** Golden Designs, Inc. warrants the sauna room against defects in material and workmanship for the life of the product from the original date of purchase. **The sauna is for outdoor use. When placed outdoors, a water proof cover or the sauna shingle roof may be installed to cover the sauna room for protection. Any damage due to direct exposure to outdoor weather elements such as rain, snow, sun, wind or extreme temperatures will not be covered by this warranty if your sauna was not designed to be directly in the weather elements. Any damages as a result of modifications made to the sauna or its components will void this warranty.**

Extent of Warranty: This limited warranty applies to products manufactured or distributed by Golden Designs, Inc. under the Golden Designs Inc. brand name, delivered in the contiguous United States or Canada and extends to the original purchaser at the original site of installation only. This warranty becomes valid at time of purchase and terminates either by specified time frame, owner transfer, or relocation. The warranty extends to the sauna room and excludes the heater as it is covered by its own manufacturer warranty. **Your sales receipt showing the date of purchase of the product is your proof of purchase.**

Manufacturer Warranty

All Golden Designs, Inc. products are manufactured with the highest quality and are warranted to be free from defects in material and workmanship at the time of delivery. The warranty is extended through the manufacturer for the product including, but not limited to: sauna room, sauna control panel, and the connected wire harnesses. All exchanged parts and products replaced under this warranty will become the property of Golden Designs, Inc. Golden Designs, Inc. reserves the right to change for any part not covered under the existing warranty. Any parts determined to be defective must be returned to Golden Designs, Inc. at its discretion to obtain warranty service. You must prepay any shipping charges, export taxes, custom duties and taxes, or any other charges associated with the transportation of the parts. In addition, you are responsible for insuring any parts shipped or returned. You must present Golden Designs, Inc. with proof of purchase documents (including the date of purchase). Any evidence of alteration, erasing or forgery of proof of purchase documents will be cause to **VOID** this limited warranty. Products on which the serial number has been defaced or removed is not eligible for warranty service. The product warranty covers parts, but does not cover labor.

Warranty Limitations

This warranty does not apply if the unit has been subject to negligence, alteration, modification, misuse, abuse, repairs by non-Golden Designs, Inc. authorized personnel, inappropriate installations, or any case beyond the control of Golden Designs, Inc. invalidating this warranty including but are not limited to:

- Improper use of lacquer or paints
- Sauna and other Golden Designs, Inc. products accessories placed on non-approved surfaces
- Outdoor applications not protected safely from outdoor weather elements, including the glass door
- Normal wear and tear or weathering
- Use of product not in accordance with instructions
- Improper use of the sauna

- Moisture or water seepage

Surface cracks are not considered defects in material or workmanship, as they are normal characteristics of all woods. This includes minor cracks due to wood expansion and contraction. Since the wood used in construction may have been kiln dried, a certain amount of expansion and contraction occurs in the wood in a sauna environment. Please note that water seepage will not hurt the wood and is a normal tendency of outdoor application. The water will usually dry quickly due to the heated environment. If you want to keep the sauna completely dry, you will need to install the barrel sauna under a covered structure.

Disclaimers

Golden Designs, Inc. shall not be liable for loss of use of sauna or other Golden Designs, Inc. products or other secondary or incidental or consequential costs, expense or damages - which may include the removal of permanent structures or other custom fixtures or the necessity for crane removal - arising directly or indirectly out of the use or inability to use the product. Any implied warranty shall have duration equal of the applicable warranty stated above. Under no circumstances shall Golden Designs, Inc. or any of its representatives be held liable for injury to any person or damage to any property, however arising. Specifications are subject to change without notice or obligation.

Legal Remedies

This limited warranty gives you specific legal rights. You may have other rights, which may vary from state to state.

Customer Service

For customer service, contact your authorized dealer. If you need additional information or assistance, please email Golden Designs, Inc. at info@goldendesignsinc.com or call (909) 212-5555.

***Limited Lifetime Warranty of Sauna Products is 5 years for residential use and 1 year for commercial use on wood structure (when properly maintained), control panel, and applicable control panel harnesses and lights from the date of purchase. Stove/heater is covered under its manufacturer's applicable warranty.**

WARRANTY CARD

Congratulations on your purchase from Golden Designs, Inc. Please take the time to complete the following Warranty Card and mail it back to:

**Golden Designs, Inc.
3550 Jurupa Street, Unit B
Ontario, CA 91761**

Please include a copy of your sales receipt showing date of purchase as this will serve as proof of purchase.

Warranty will be VOID if the following warranty card is not mailed back within 60 days of purchase date along with proof of purchase.

****Serial number (S/N) is located on the sauna’s front panel, rear panel, or on the carton.****

DETACH HERE



WARRANTY CARD

All fields must be completed to validate the warranty.

Name: _____

Address: _____

City: _____ State: _____ Zip Code: _____

Phone Number: _____

Purchase Date: _____

Product Name: _____

Purchase From: _____

Serial Number: _____

