

Assembled dimensions (mm)

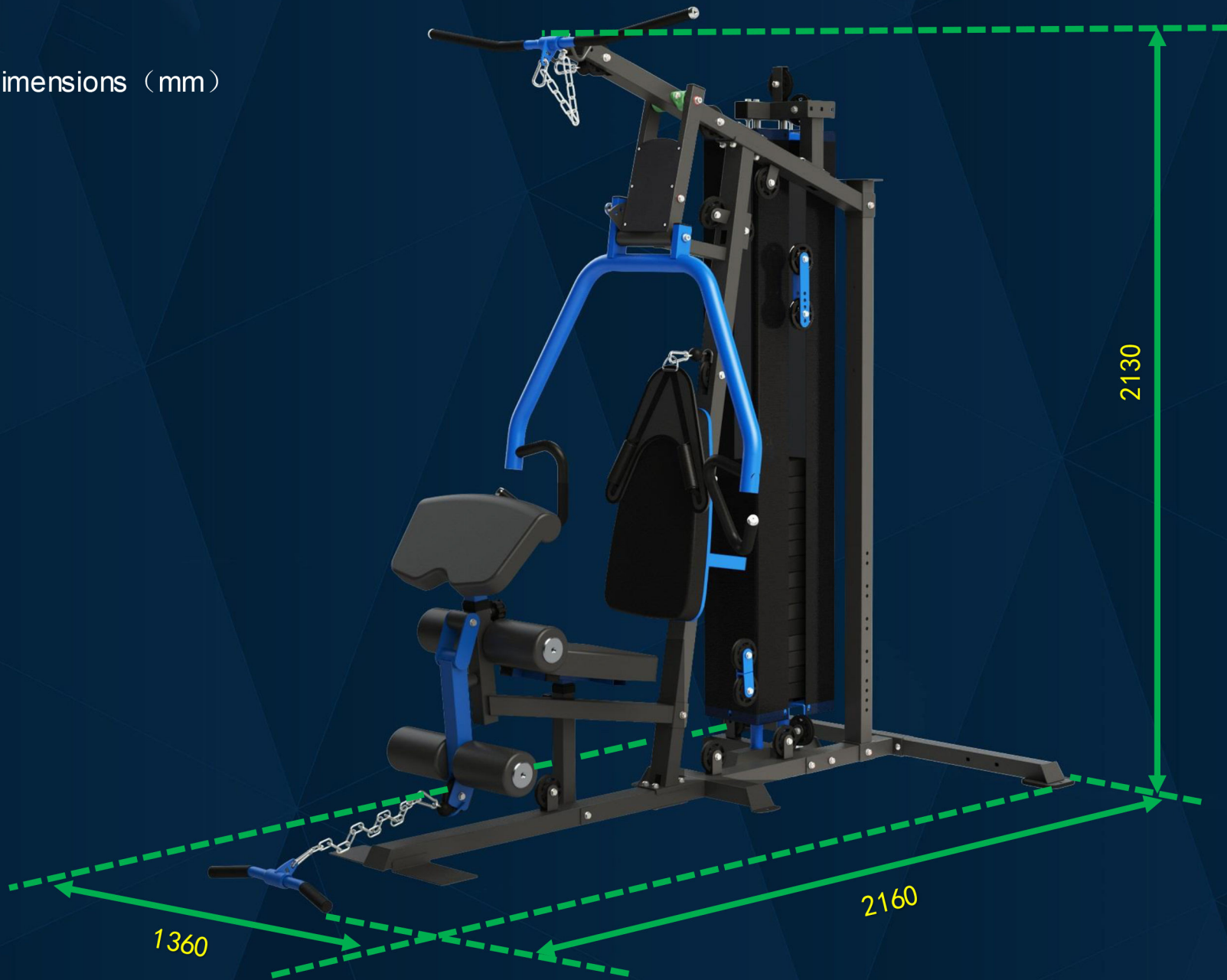

Maximum weight & Main tube size

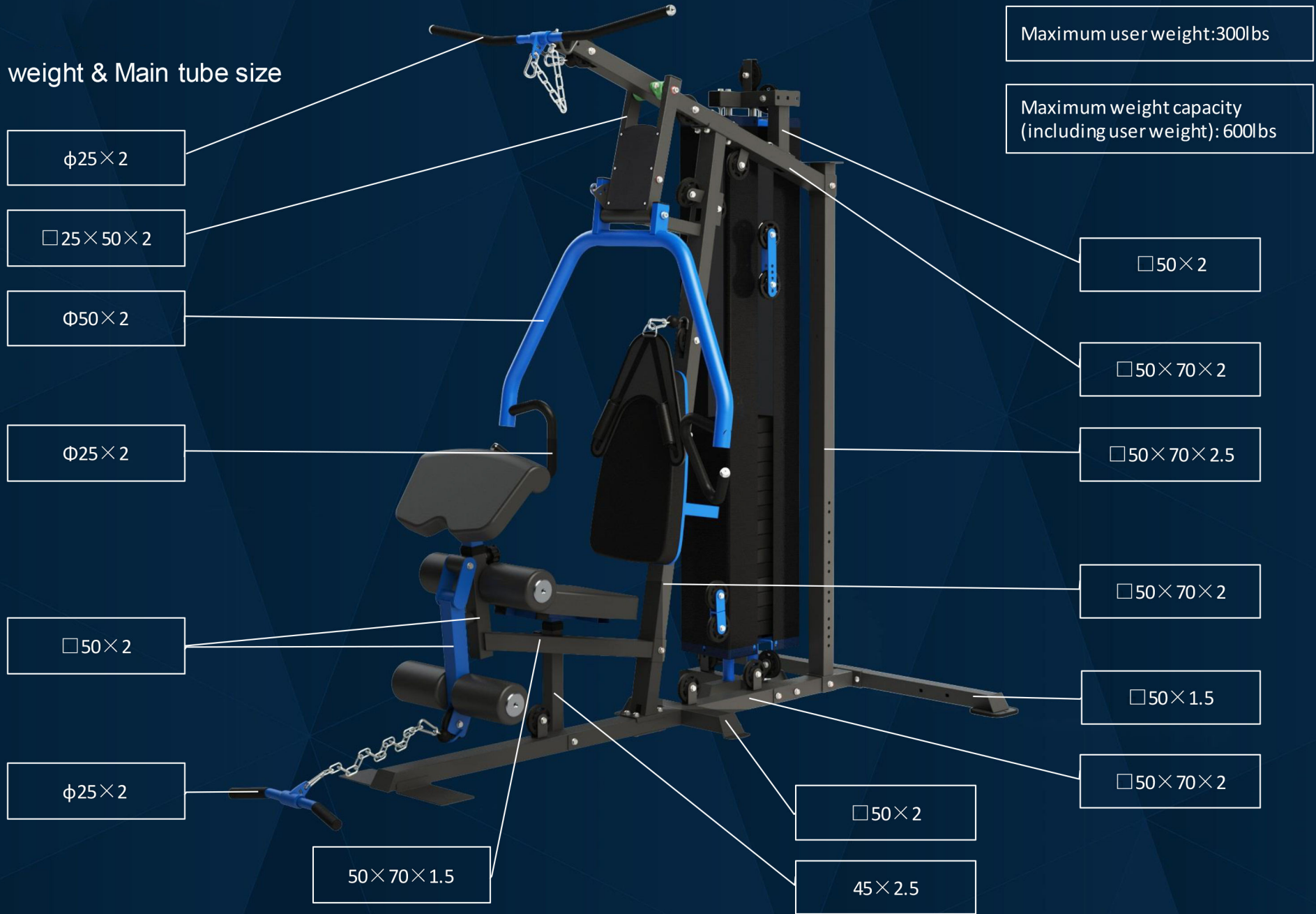

Characteristic

HDR grip

Arc butterfly design

Adjustable backrest pad

Adjustable arm curl pad

Leather foam

Non-slip metal footplate

Super flexible PP pulley (Same as bumper material)

Cable diameter: 5mm

Canvas shield not only has the protection effect but also increases the stability of the machine.

weight stack is
 $5\text{kg} \times 15 = 75\text{kg}$

T super stable base

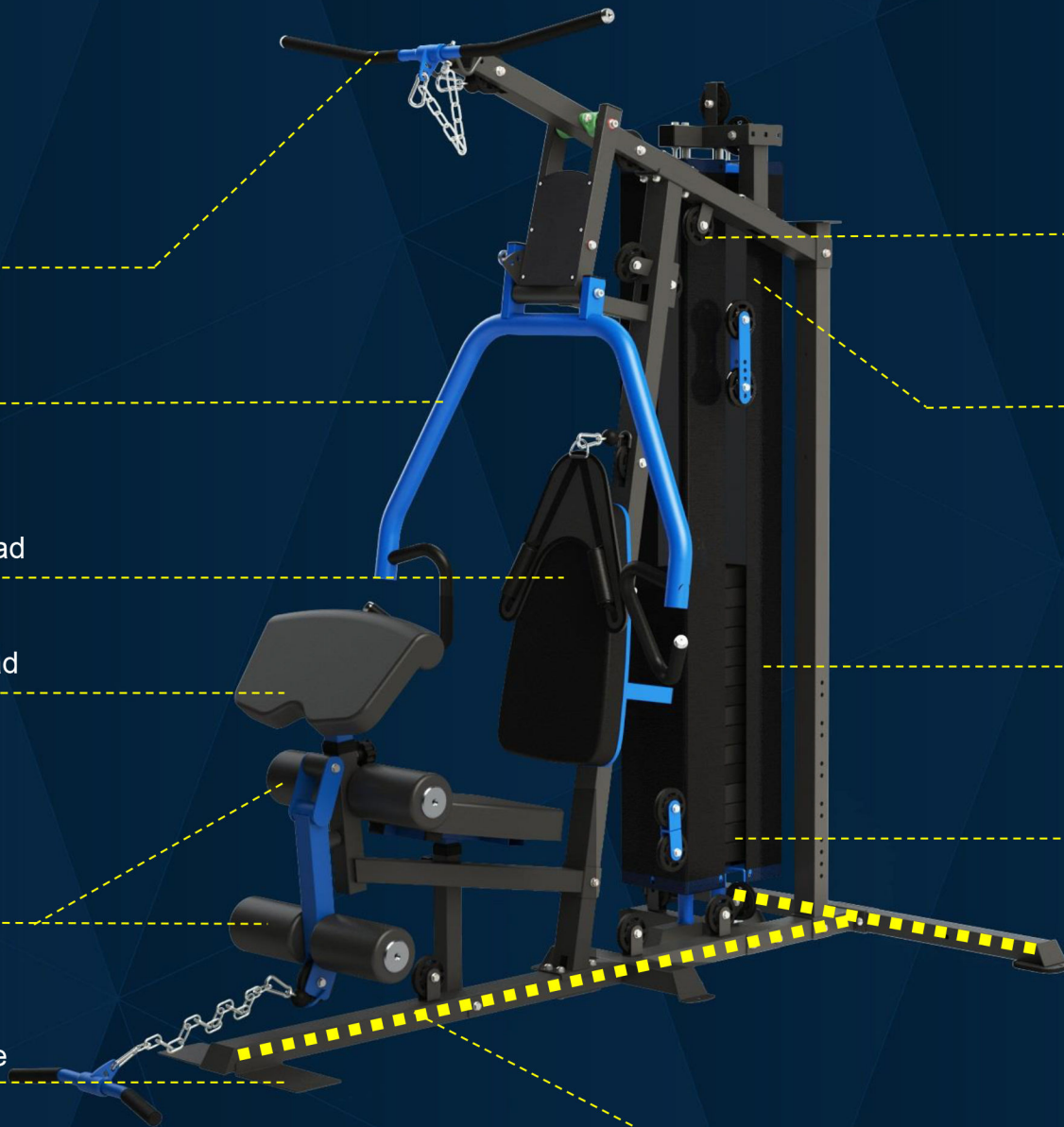

Adjustable butterfly

Φ5mm Cable . Pass through 800 kg tension test. The cable is tensile, wear-resisting and safe.

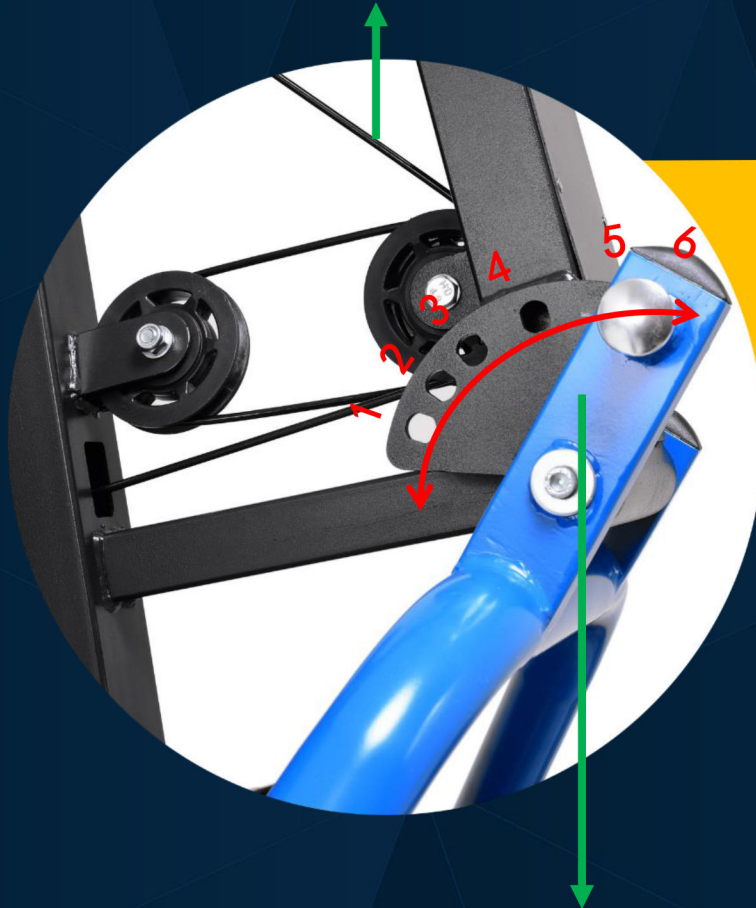

6 adjustable butterfly machine can do both chest and back exercise by adjusting position.



Adjustable arm curl pad

Double blue color formed the unique production process.

2 position to adjust the height of arm curl pad. Please adjust towards this direction.



High elastic leg foam

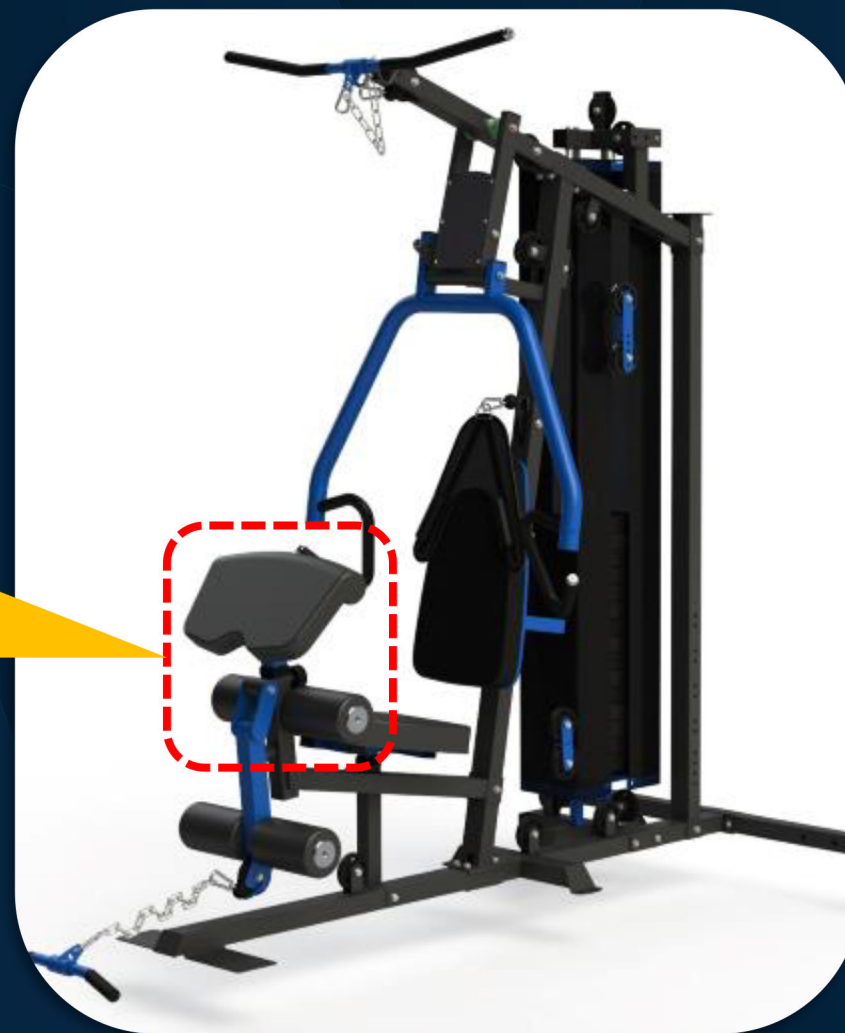

Detail display

Galvanized gourd hook can be easily adjusted.



10 ring adjustable iron chain can meet different training needs.

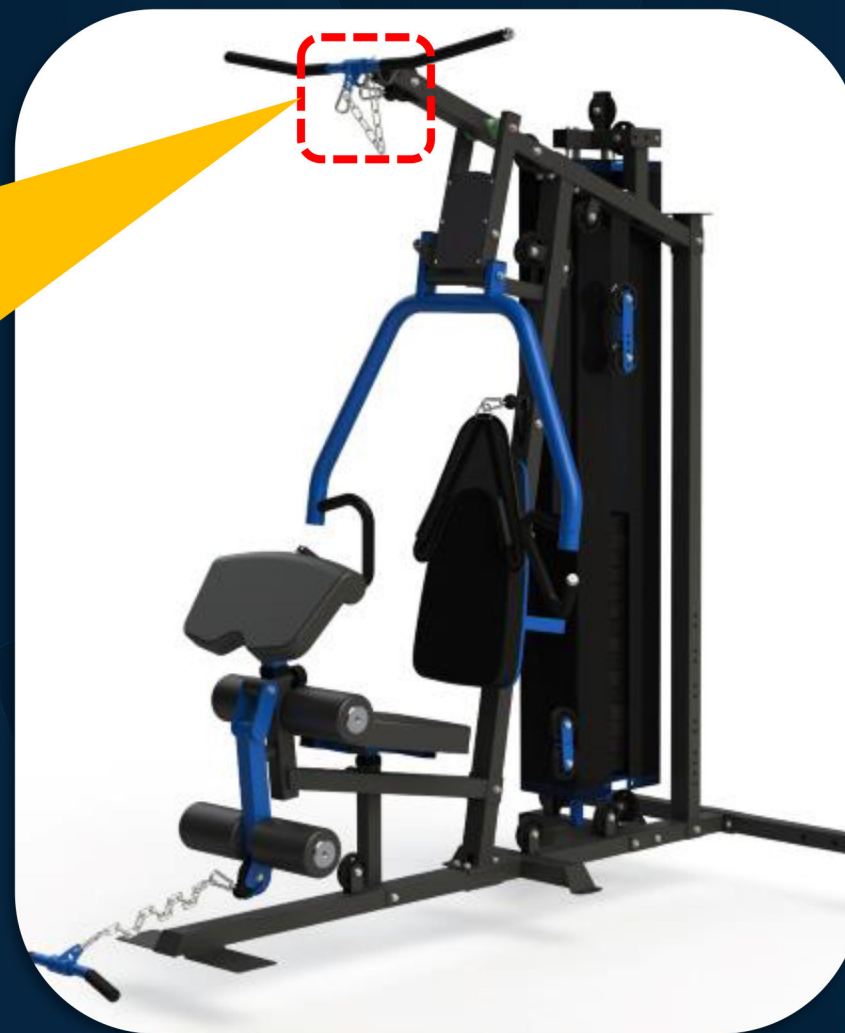

Adjustable backrest pad

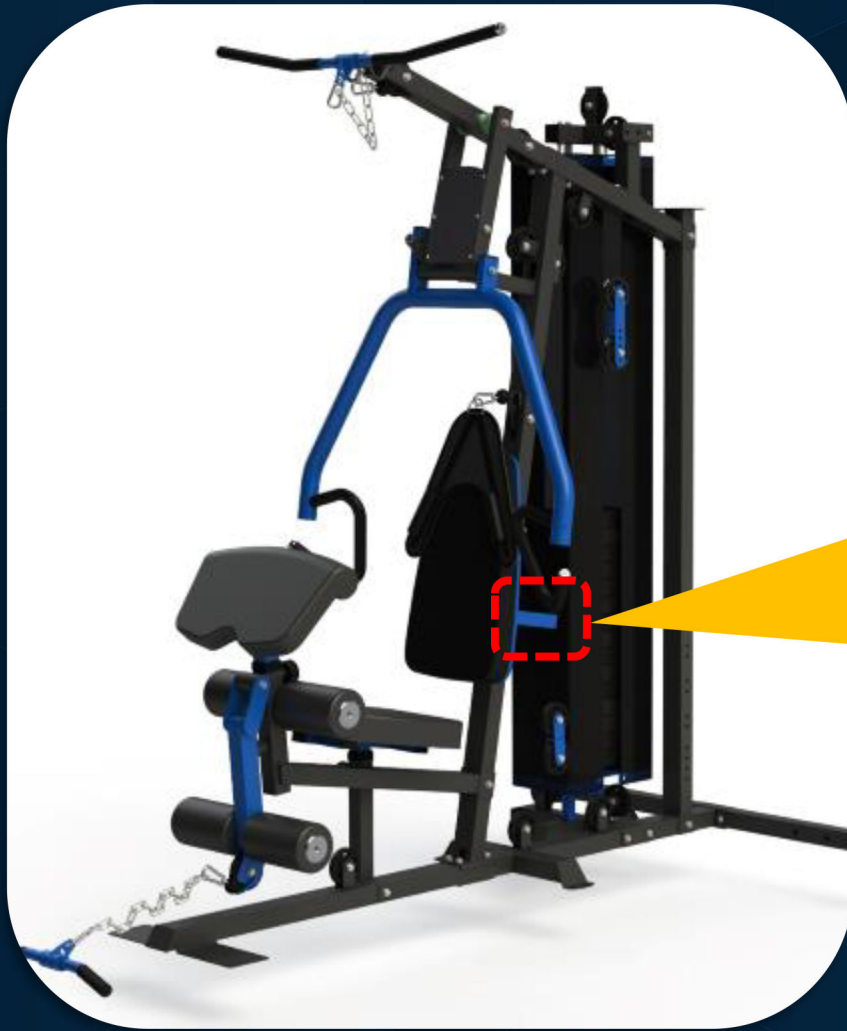

6 position adjustable backrest pad can meet the different height users.

