

A woman with a long braid, wearing a light-colored bikini, is kneeling on a white towel on a wooden bench inside a far-infrared sauna. She has her hands clasped in a prayer position and her eyes are closed. The sauna has wooden walls and a glass door. The text is overlaid on the image.

KIVA WELLNESS
FAR-INFRARED SAUNA
1- 3 PERSON USER MANUAL



Get ready to relax, restore,
reset and rejuvenate with your new Kiva Wellness
Far-Infrared Sauna.

We are so excited for you to start your sauna journey and experience all of the health benefits your sauna has to offer.

Please read the user manual carefully before using, pay special attention to the safety precautions and keep for future reference.

KIVAWELLNESS.COM.AU

SUPPORT@KIVAWELLNESS.COM.AU | 07 4270 8000

@kivawellness   



CONTENTS

—

4

Kiva Sauna Promise

5

Safety Sheet

6

Installation Requirements

7

Parts & Features

8

Installation Process

10

Control Panel & Box

12

Trouble Shooting

13

Cleaning & Maintenance

14

Sauna Tips

15

Supercharging Your Sauna Experience

16

Warranty

Kiva Sauna Promise

ELEVATING YOUR WELLNESS & RECOVERY
THROUGH INNOVATIVE TECHNOLOGY

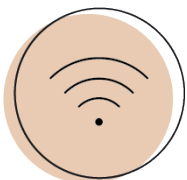

LOW EMF

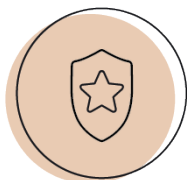

LIFETIME WARRANTY
ON HEATERS

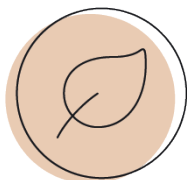

NON-TOXIC
MATERIALS

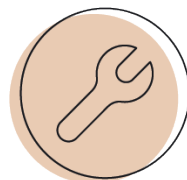

EASY TO
ASSEMBLE

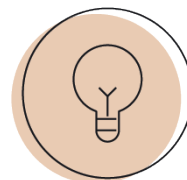

ENERGY
EFFICIENT

Safety Sheet

- The Kiva Wellness Far-Infrared Sauna is designed to be stand alone or built-in to your bathroom, pool, or spa area.
- It is recommended to install the sauna indoors for maximum protection and longevity.
- If installed outside, whether it's on a deck, veranda or in a purpose built space, it must always be completely covered and sheltered from rain, moisture, and other elements in order to protect the naturally untreated wood finish.
- Children should be supervised at all times. Children over the age of 6 years may use the sauna under adult supervision.
- The sauna should not be used if you have any open wounds, eye diseases or severe sunburn.
- Elderly, pregnant women and infants should not use the sauna.
- Exit the sauna immediately if you feel uncomfortable, dizzy, or sleepy.
- People with health conditions or diseases directly related to temperature should consult their doctor before using the Kiva Wellness Far-Infrared Sauna.
- CAUTION: Hyperthermia can occur when the internal temperature of your body reaches a level several degrees above normal body temperature of 37°C (98.6°F).
- The symptoms of hyperthermia include an increase in the internal temperature of the body, dizziness, lethargy, drowsiness, and fainting.
- The effects of hyperthermia include failure to perceive heat and to recognise the need to exit the room, unawareness of impending hazards, fatal damage to pregnant women, physical inability to exit the room, and unconsciousness.
- Do not use the sauna if under the influence of drugs or alcohol.
- WARNING: The use of alcohol, drugs, or medication is capable of greatly increasing the risk of fatal hyperthermia.
- Remove all jewellery before entering the sauna.
- To avoid fire, do not dry clothes or leave any towels in the sauna.
- While in the sauna, do not touch the light bulb. If the bulb needs to be changed, switch the sauna off and wait until the light bulb has completely cooled.
- Do not spray water on the infrared heating elements. This activity may result in electric shock or damage to the heating elements.
- Do not place pets in the sauna.
- If the sauna becomes too warm, open the vent in the ceiling or open the front door.
- After your sauna session, turn off and unplug the power cord.

Installation Requirements

- Before connecting the sauna to a power source, please ensure all the wires, cords and connections are properly connected.
 - Plug the sauna into a proper wall power outlet. Do not share the same outlet with any other appliances.
 - Install the sauna on a completely level surface and in an area that is dry and protected from the weather.
 - **WARNING:** To reduce the risk of electrocution and burns, do not operate unless the heater guard is correctly in place.
 - **CAUTION:** Do not place combustible materials on or against heaters at any time.
 - To reduce risk of electric shock and/or fire, do not expose the control system to water or rain. Do not open the cover to the control system as there are high tension fittings that can be dangerous. Only authorised and approved technicians should make any necessary repairs.
 - Any unauthorised repairs, alterations or modifications can lead to serious injury and can cause the sauna to operate outside its intended specification parameters which will void the warranty.
 - **WARNING:** Reduce the risk of electrocution by disconnecting the power supply before servicing.
 - Do not spray the exterior with water. If the area you are installing the sauna has a tendency for dampness, place rubber matting or other suitable barriers underneath the sauna.
 - Keep all liquids away from the heating panels and electronics.
 - Keep flammable objects and corrosive chemical substances away from the sauna.
 - To prevent burns or electrical shock, do not touch or use metal tools on the far-infrared heating elements or the net cover of the far-infrared heating elements.
-

Parts & Features

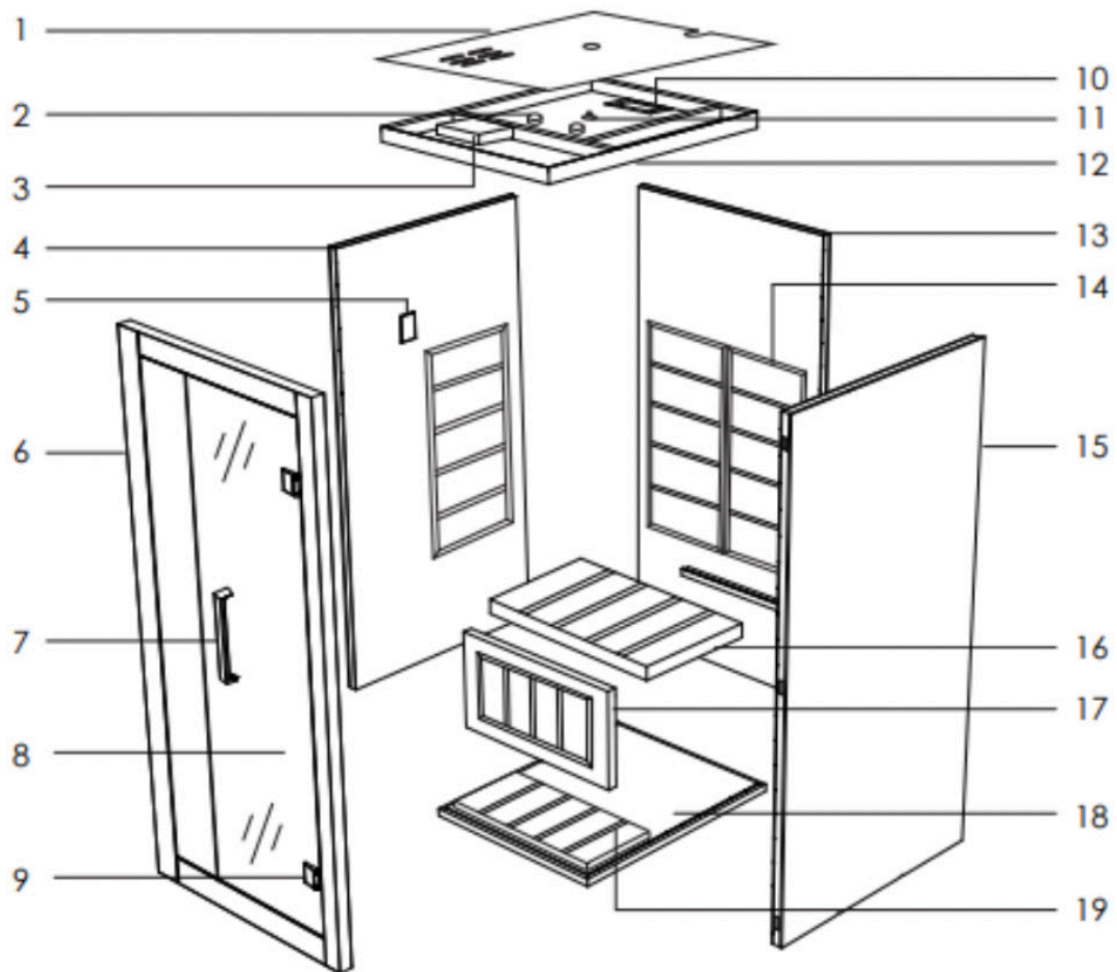

- 1 - Top Cover that keeps dust etc off way from Ventilation and Control Panels
- 2 - Speaker
- 3 - Control Box
- 4 - Left Panel (Left Wall)
- 5 - Inside Control Panel for Operation
- 6 - Front Panel (Contains Glass)
- 7 - Handle for Front Panel
- 8 - Glass Door
- 9 - Door Hinge
- 10 - Ventilation Door

- 11 - Temperature Sensor
- 12 - Top Panel (Roof)
- 13 - Back Panel
- 14 - Heating Panels
- 15 - Right Panel (Right Wall)
- 16 - Inside Bench (For Sitting)
- 17 - Bench front Board
- 18 - Bottom Board (Base of Unit)
- 19 - Foot Rest Panel

Installation Process

This process is easiest with at least 2 adults working together.

Structural Creation

1. Start with the bottom panel place it in your desired location and ensure the front part of the panel is placed in the correct direction.
2. Assemble the back panel by aligning the back panel with the corresponding battens on the bottom panel making sure they are in the same line. One person should hold the back panel while the other person continues to the next step.
3. Assemble the left panel by aligning the left panel with the bottom panel and the corresponding battens. Make sure the left panel fits flush into back pane. At this point use the latches. Once the back and side panel are all together on the floor, panel you can now close and latch it.
4. Assemble the right panel by aligning the right panel with the bottom panel and make sure it fits correctly into the battens. Latch this together.
5. Assemble the bench front board by sliding the bench front board down vertically into the slot within the left and right panel.
6. Assemble the bench seat by placing the bench seat on the corresponding battens of the backboard.
7. Place the Foot Rest board down in front of the bench front board.
8. Assemble the front panel by aligning the front panel with the corresponding battens on the bottom panel. Then latch it with the left and right panels. Please take caution with the glass door.
9. Now for the top panel, make sure all wires and connecting plugs are slipped through the corresponding holes of the internal top panel. All these wires should be connected to the controller on the internal top panel.

Electrical Connection

1. Put any wires from the front and back panels back into the centre of the sauna cabinet to avoid pressing them when installing the internal top panel.
2. Connect all the wires and connectors to the corresponding outlets on the internal top panel. Make sure connections are tight and secure.
3. The last step is to secure the external top panel over the internal top panel. Align the top panel and secure it with the screws supplied.
4. Installation should now be complete. Plug in the power and turn the sauna on at the control panel.

STRUCTURAL CREATION (DO FIRST)

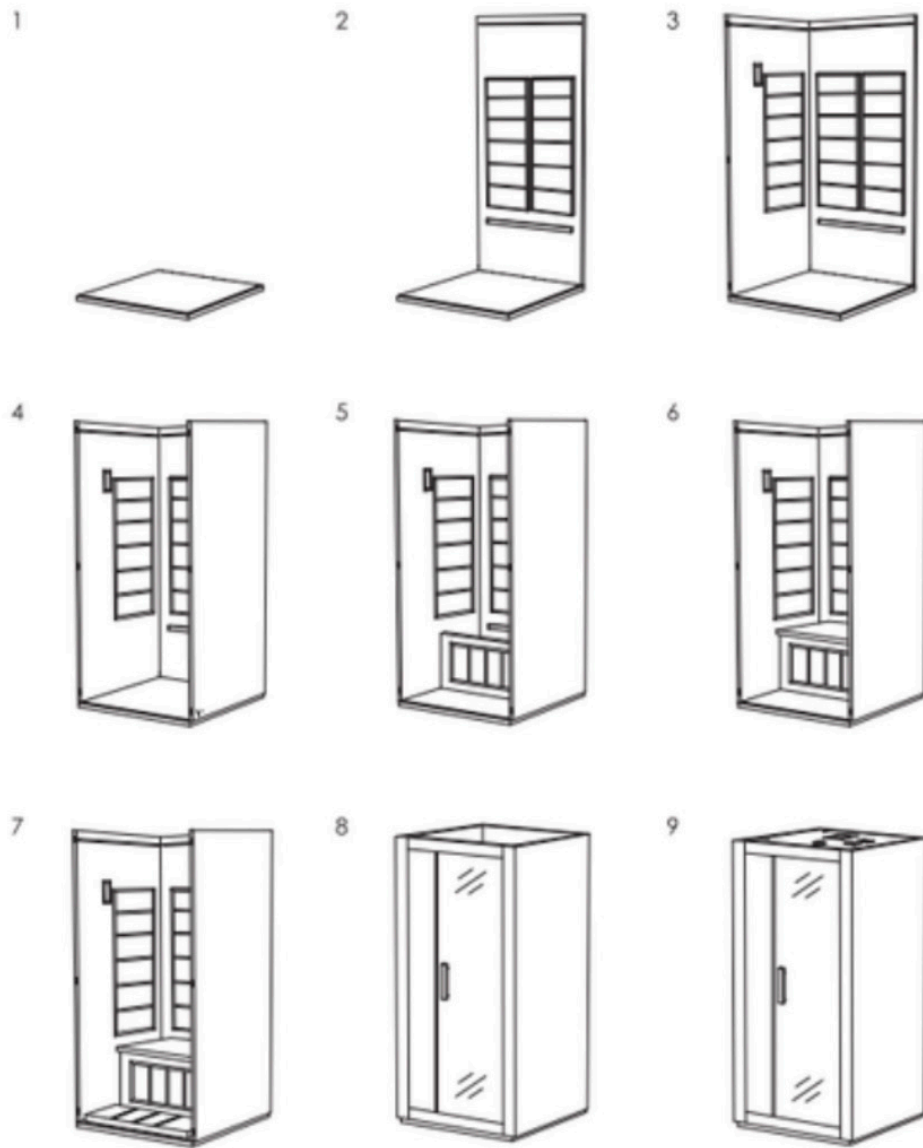

LATCHES (CONNECTING PANELS WITH EASE)

Outer buckle installation method



Hanging buckle installation method

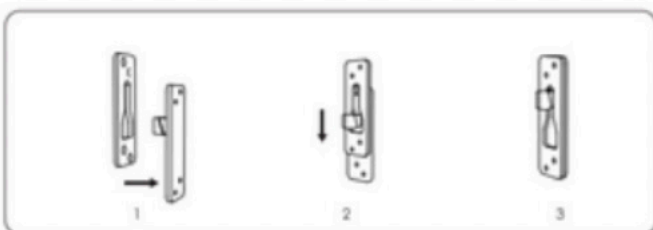

ELECTRICAL CONNECTION (DO LAST)

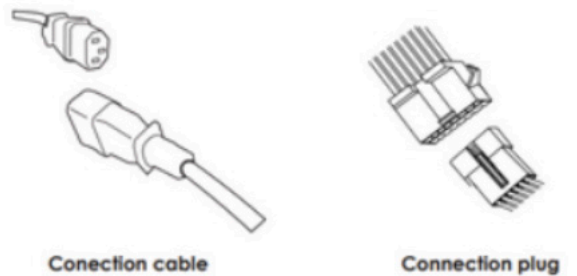

Connection cable

Connection plug

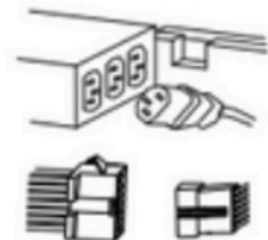

Control Panel

3: USB Port - Available to play music.

4: Light Button - This button is used to switch your internal light on or off. If the keypad itself is lit up then the light is powered on. Once the light is on, if you wish to change the colour of the light simply hold down the light button for a few seconds, the display will change and say 2n. Once this happens release the light button and press it again and again until you get the light colour of your choice.

Once you have the colour of your choice stop pressing, you will notice the 2n will disappear.

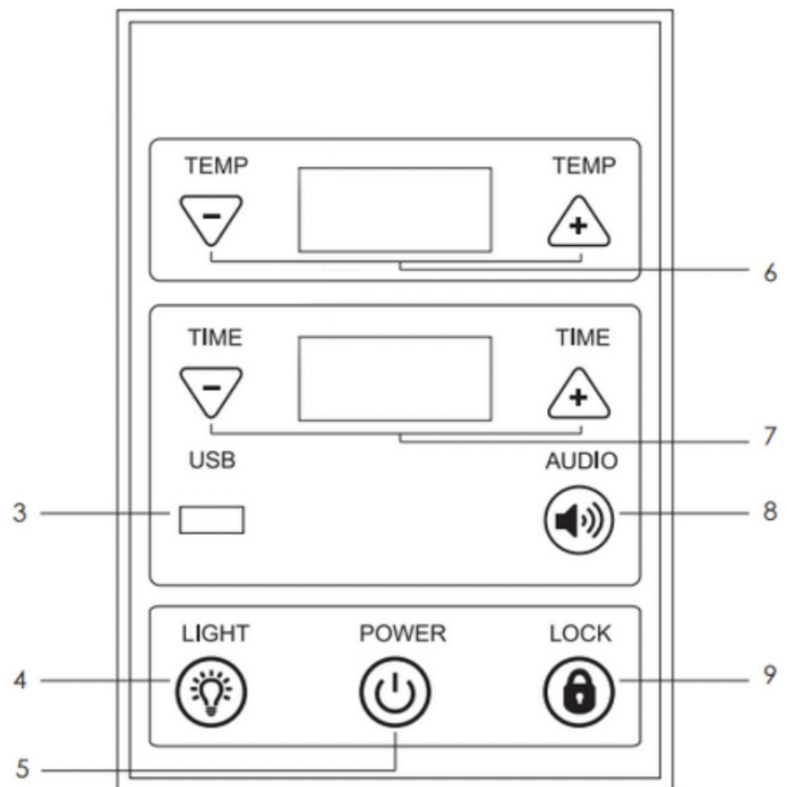

5: Power Button - Hold for 3 Seconds to switch on your Sauna heaters. Hold for 3 Seconds to switch your Sauna off.

6: Temperature Control - Once you have turned on the Sauna via the control panel you can adjust the heat setting to your required amount. Simply press the up or down button and the temperature will increase or decrease by 1°C with each press. The Temperature range is 30 to 75°C. Whilst the unit is warming up and is below 30°C the control panel will display LO.

If you wish to switch to Fahrenheit instead of Celsius then press down LOCK and TEMP- at the same time (Whilst the control panel is on) Fahrenheit temperature changes are in 5°F increments.

7: Timer Control - This button allows you to set a timer for your sauna session. Simply use the + and - buttons to adjust the time to your liking. The timer range is 5 - 60 mins.

8: Audio Function - Pressing the AUDIO button once will begin to prepare your Sauna for Bluetooth sync with your device. Your control panel will display BLU. To sync go to the Bluetooth setting in your device and you will be able to find your Sauna here (BT Sauna) to enable Syncing. This can take up to 10 seconds to complete so be patient.

If you press your AUDIO button again it will switch options to include USB or Radio.

Whilst on USB you can connect your device to your Sauna and the sound from your device will play out of the speakers in the Sauna. It takes 3 seconds to recognise your USB device.

If you are on Radio you may notice the channels are fuzzy. To improve this, whilst on radio hold down the Audio button. You will see the frequency change to a number of small lines that flash. Please be patient, your Sauna is finding good quality reception. Once this stops you can move through the channels by using the TEMP - & + buttons.

9: Lock Function - Use this button if you want to lock your sauna settings throughout your session to avoid your settings changing if the control panel gets brushed.

Control Box

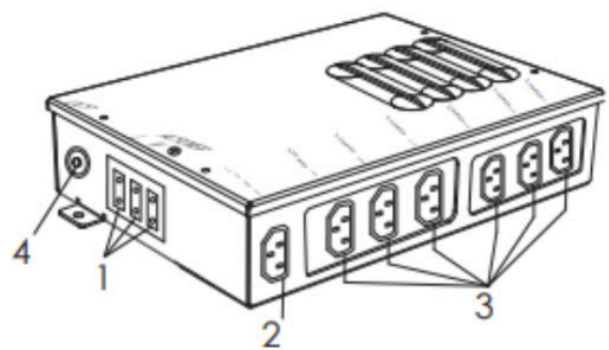
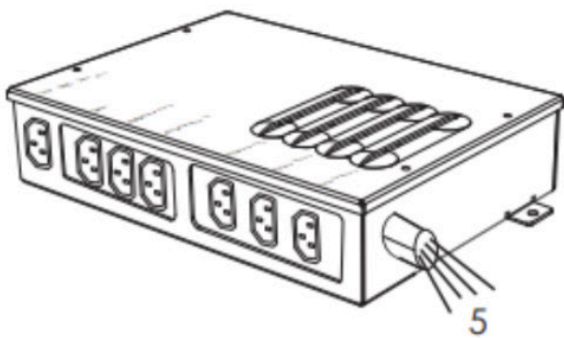

This is the control box that is positioned at the top of your Sauna.

This image explains the connections.

You will need to plug in your heater panels to one of the plugs #3 and your lamp to #2.

1 : Main Power for your Kiva Wellness Sauna

2 : Lamp Power Output cable

3 : Heaters Power output cables (Loads A-F)

4 : Fuse reset

5 : Powers the following:

- 12v Output
- Temperature Sensor
- Control Panel
- Radio Antenna
- USB Output
- LED Lamp
- Speakers

Trouble Shooting

PROBLEM	POTENTIAL REASON	NEXT STEPS
Power indicator light is not working	<p>The connectors are not connected properly</p> <p>No power supply input</p> <p>The power indicator light is faulty</p>	<p>Check the connectors</p> <p>Check the power outlet on the wall & power supply on the top panel (sauna roof)</p> <p>Contact our customer service centre, details on the last page</p>
Heat indicator light is not working	<p>The heat indicator light or circuit board is faulty</p> <p>The temperature sensor is faulty</p>	<p>Contact our customer service centre, details on the last page</p>
The carbon far-infrared heaters are not heating up	<p>The carbon far-infrared heaters are faulty</p> <p>The wire junction or the heater's wire is loose</p> <p>The temperature sensor is faulty</p> <p>The circuit board is damaged</p>	<p>Contact our customer service centre, details on the last page</p>
Light is not working	<p>Light bulb wiring is loose</p> <p>The electrical control panel is faulty</p>	<p>Light bulb wiring is loose</p> <p>The electrical control panel is faulty</p>
The temperature display screen shows "EP"	<p>The temperature sensor connector is loose or the sensor is faulty</p>	<p>Tighten the temperature sensor connector</p> <p>or</p> <p>Contact our customer service centre, details on the last page</p>
The temperature display screen shows "H"	<p>The temperature inside the sauna is too high</p>	<p>The sauna is too high, turn off sauna and please contact our customer service centre, details on the last page</p>



Cleaning & Maintenance

- Always follow the instruction manual when using your Kiva Wellness Far-Infrared Sauna so that it is maintained in the best possible shape and you can enjoy longevity of your investment.
- To maintain the appearance of wood, place a towel on the sauna bench to prevent sweat from dripping onto wooden surfaces.
- After use, open the door of your sauna. This process will release moisture and help to keep the wooden surfaces dry.
- Avoid using sharp objects inside the sauna to prevent damage to internal fixtures and surfaces.
- Use soft paper or a microfibre cloth to clean the glass door.
- Do not use liquid or aerosol cleaning products inside the sauna.
- Unplug the sauna from the power outlet on the wall before cleaning. Do not use alcohol or strong cleaning chemicals to clean the sauna. NOTE: Use of chemicals will damage the wood and any natural protection layer inherent in the wood.
- Do not store the sauna in damp environments as this can cause the wood to stain and rot.

Sauna Tips

Pre sauna hydration is much more important than drinking water throughout your session. Make sure to drink plenty of water prior to commencing your sauna session. This will ensure your body is adequately hydrated and able to perspire safely.

Make sure to rehydrate after your sauna session to help reduce heat stress. It is recommended to drink plenty of fluids 2-3 hours post sauna session.

To maximise hydration pre and post sauna, try out this delicious fruity infused coconut water recipe.

FRUITY INFUSED COCONUT WATER

All you need:

- 2 cups coconut water
- 2 cups water
- 2 cups fruit of choice (fresh or frozen)

Method:

1. Fill a large jug with coconut water and filtered water
2. Add fruit slices to the jug and stir
3. Place jug in the fridge for at least 30 minutes to chill and infuse
4. Serve in glasses over ice



Supercharge Your Sauna Experience

WITH THESE SELF CARE RITUALS



Light stretching: helps to loosen tight muscles and increase flexibility



Hydration: sip and celebrate your sauna experience with a fresh juice, filtered water or chilled coconut water



Massage: use your favourite massage tool or hands to lightly rub muscles to relieve tension



Deep breathing/meditation: releases tension, promotes relaxation and a sense of calmness



Dry brushing: helps to detoxify the body, deeply exfoliate and leaves skin feeling smooth and fresh



Read: take this time to unwind and get lost in a good book



Podcasts / playlist: use the bluetooth function on the sauna control panel to take your listening experience to the next level. This is the perfect way to catch up on your favourite podcast or unwind with your favourite music playlist.



Hair mask: helps to prioritise self care and give your hair some TLC

Warranty

Warranty Period: lifetime warranty on carbon heaters and 5 year general.

Kiva Wellness are the warranty providers for Kiva Wellness products. Kiva Wellness warranty this product to be free from defects in materials and workmanship while in normal domestic use for a period of one year on parts and labour (with the exception of a life warranty on the carbon heaters) from the original date of purchase.

Do not return your sauna to the store you purchased from before contacting Kiva Wellness directly.

LOGGING A WARRANTY CLAIM

Should you experience any issues with your product, please follow the below steps to lodge a warranty claim:

1. Contact Kiva Wellness and let them know the following details:
 - Your warranty details including name, email and phone number
 - Product name and model number
 - Product serial number, found on the rating label of the product
 - Explanation of how the damage occurred
 - Photos of the damage or issue is highly beneficial to expediting your claim
2. Kiva Wellness will assess your claim and respond within 24-48 hours. If the product exhibits a defect while in normal domestic use and within the warranty period; Kiva Wellness will either repair or replace the product or defective part free of charge.
3. In the event that the product is required to be sent to the service centre, the customer is required to pay for all packing, freight and insurance costs for transit of the product to Kiva Wellness. This is subject to the applicable consumer laws in your jurisdiction.
4. If the product, or one of its parts, qualifies for replacement or service within the 30-day period after the date of purchase, Kiva Wellness will arrange the shipping at no cost to you.
5. Any product sent to Kiva Wellness must include a return authorisation form that will be provided to you after your warranty claim is accepted. Failure to include this form may result in the product being rejected from the warehouse or a delayed service time.
6. In the event that the warranty period for a product has expired, or if a product does not qualify for warranty service, repair or replacement, customers can still buy replacement parts or have products repaired by one of the Kiva Wellness service centres. Please contact Kiva Wellness for further information. Kiva Wellness will contact you with a quote prior to undertaking any service work outside of the warranty coverage.
7. Typical turn-around times to address warranty claims can be between 10-14 business days, plus shipping, depending on location and type of damage or warranty claim.
8. In no event will the liability exceed the retail value of the product. We make no warranty with respect to parts, from a source other than Kiva Wellness.

9. In the event that warranty parts or products are provided, the customer must cover the related shipping costs to receive goods.

10. All exchanged or substitute parts and products replaced under warranty service will become the property of Kiva Wellness. Repaired or replaced products or parts thereof will be warranted by Kiva Wellness for the balance of the original warranty period.

11. (Australia only) Kiva Wellness goods come with guarantees that cannot be excluded under the Australian Consumer Law. You are entitled to a replacement or refund for a major failure and compensation for any other reasonably foreseeable loss or damage. You are also entitled to have the goods repaired or replaced if the goods fail to be of acceptable quality and the failure does not amount to a major failure.

WARRANTY DOES NOT COVER

1. Damage, accidental or otherwise, to the product, not caused by a direct defect in factory workmanship or materials.

2. Damage due to abuse, mishandling, alteration, misuse, commercial service, tampering, accident, failure to follow the care, operating and handling provisions indicated in the instructions.

3. Damage caused by parts or services not authorised or performed by Kiva Wellness.

4. 'Normal' wear and tear that naturally and inevitably occurs as a result of normal use or ageing.

5. Some states do not allow the exclusion or limitation of incidental or consequential damages. Therefore, the above limitations may not apply to you in the case of damage in shipment. If your product was damaged in shipment: Immediately report this type of damage to the parcel carrier and have them file an inspection report to contact the distributor from whom you purchased the product for further instructions.

6. You have rights and benefits under the consumer laws in your jurisdiction. Without detracting from these rights or benefits, Kiva Wellness excludes all liability in respect of this product for any other loss which is not reasonably foreseeable from a failure of this product, which may include liability for negligence, loss of expenditure associated with the product and loss of enjoyment.



EMF Test Results

MEASURING DISTANCE: 30MM

TEST PROCEDURE: EN 62233:2008

FREQUENCY RANGE: 10HZ-400KHZ

TEST VOLTAGE: AC120V / 60HZ

RESULT: PASS

FRONT 1.139% (OF RECOMMENDED ALLOWABLE RADIATION LIMIT: 100%, 10MG)



REAR 1.137% (OF RECOMMENDED ALLOWABLE RADIATION LIMIT: 100%, 10MG)

KIVA WELLNESS

ELEVATE YOUR WELLNESS & RECOVERY

KIVAWELLNESS.COM.AU

07 4270 8000

@kivawellness   

Kiva Wellness products should not be considered medical devices, and should be treated as general wellness products only. Our product range has not been designed to prevent or treat medical conditions, and we recommend you consult a health practitioner if you are unsure about whether a Kiva Wellness product is suitable for you.