



KIVA WELLNESS  
ENERGISE ICE BATH  
**USER MANUAL**

Get ready to take the plunge and unlock a new level of wellbeing with the Energise Plunge Ice Bath.



Treat the nervous, immune, and cardiovascular systems to some cold water therapy & unlock a new level of commitment, discipline and will power with this mindfulness challenge.

We are so excited for you to start your Kiva ice bath journey and experience all of the health benefits the Energise Plunge has to offer.

Please read the user manual carefully before using, pay special attention to the safety precautions and keep for future reference.

KIVAWELLNESS.COM.AU

SUPPORT@KIVAWELLNESS.COM.AU | 0742 708000

@kivawellness   





# CONTENTS

—

5

Mission, Vision & Values

7

Safety Sheet

8

Installation Process

13

Maintenance

14

Failure Codes + Parameter Table

15

Troubleshooting Guide

17

Name Plate & Wiring Diagram

18

Warranty





Mindfully Created For Your Wellbeing.

Here at Kiva Wellness we combine innovative technology with meaningful local support. Now you can take your wellness and recovery into your own hands, and into your home.

Invest in you, your rituals and your radiance. Reap the life enhancing rewards with a Kiva Wellness transformation.

KIVAWELLNESS.COM.AU

SUPPORT@KIVAWELLNESS.COM.AU | +61 288 800749

@kivawellness   



# Our Mission & Vision

Our vision is to facilitate a better quality of life by creating access to innovative therapies and fitness equipment.

Inspiring and enhancing experiences of exercise and relaxation regularly and without barriers, one session at a time all in the comfort of your home.

Connecting people with unique wellness solutions and empowering ownership of health & wellbeing.

---

## Our Values

We put **people first** because health is uniquely yours, and we are all on a different journey to achieving total wellbeing.

We value **kindness** and always strive to being genuine with our community and our endeavours. **Growth** is important to us so we can continue to offer meaningful support and innovative products as our community continues to grow.

We want our customers to have **access** to elevating their health at home and being able to get the products of their choice without barriers.

We seek **sustainable** outcomes for every aspect in our business, consciously reducing our footprint wherever we can.

# Our Kiva Promise

ELEVATING YOUR WELLNESS & RECOVERY  
THROUGH INNOVATIVE TECHNOLOGY



SET UP INSIDE  
OR OUTDOORS



5 YEAR  
WARRANTY

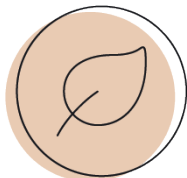

NON-TOXIC  
MATERIALS



EASY TO  
ASSEMBLE

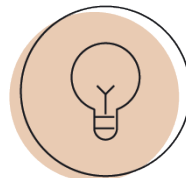

ENERGY  
EFFICIENT

# Safety Sheet

This ice bath can be used by children aged from 8 years and above, and persons with reduced physical, sensory or mental capabilities if they have been given supervision or instructions concerning use of the appliance in a safe way, and understand the hazards involved. Children should not be permitted to play with the ice bath. Cleaning and user maintenance should be conducted by adults only.

Do not place hands or any other object into the air outlet and fan, as it could damage the chiller and cause injuries. In the instance of any abnormality found in the chiller, please cut off the power and contact us immediately. It is strongly suggested to place a guard around the machine to keep children away from the chiller.

# Installation Process

Before installing the chiller, check that your local power supply meets the requirements needed.

Fit the electrical protection devices in compliance with local regulations. For safety reasons, you should not replace or repair the chiller yourself. If the ice bath requires repairs, please contact us for assistance.

Now connect your Chiller box to the tub using the 2 hose attachments included with your ice bath.

Firstly take the white Teflon tape included with your ice bath and cover the 4 x pipe connectors, 2 on the bath and 2 on the chiller box. This will reduce leaking.



Now add 1 x O ring to the inside of the hose attachment before screwing your hose attachments together with the tub and chiller.





Once both hoses are securely attached to both the chiller and tub you can begin to fill your bath with water.

Do not place objects inside the chiller while it is working. They could come into contact with the fan and damage it, or cause an accident. Do not use the chiller without the grille or plaque, as this could cause the ice bath to malfunction. The ice bath may only be reset following a full inspection by a qualified service engineer. Unqualified service engineers may not adjust the ice baths switchboards, valves or controllers.

The ice bath can be set up in any location provided there's fresh air, electrical access and pool filter piping. Do not place the ice bath in an enclosed area with limited air volume where discharged air will be re-circulated. The ice bath should also not be set up in a location where the air inlet could be blocked. These locations deny the ice bath a continuous fresh air supply, which reduces its efficiency and may prevent adequate heat yield.

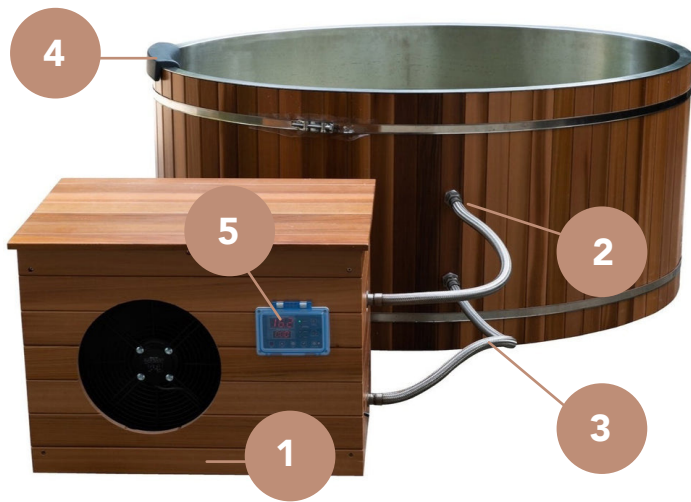

- 1 - Chiller Box
- 2 - Water Inlet Hose (Top One)
- 3 - Water Outlet Hose (Bottom One)
- 4 - Headrest
- 5 - Control Panel (on Chiller Box)

In order for the ice bath to cool, the filter pump must be running so that the water can circulate through the chiller. Without this circulation, the chiller will not start. When all connections have been made and checked, the following steps should be followed:

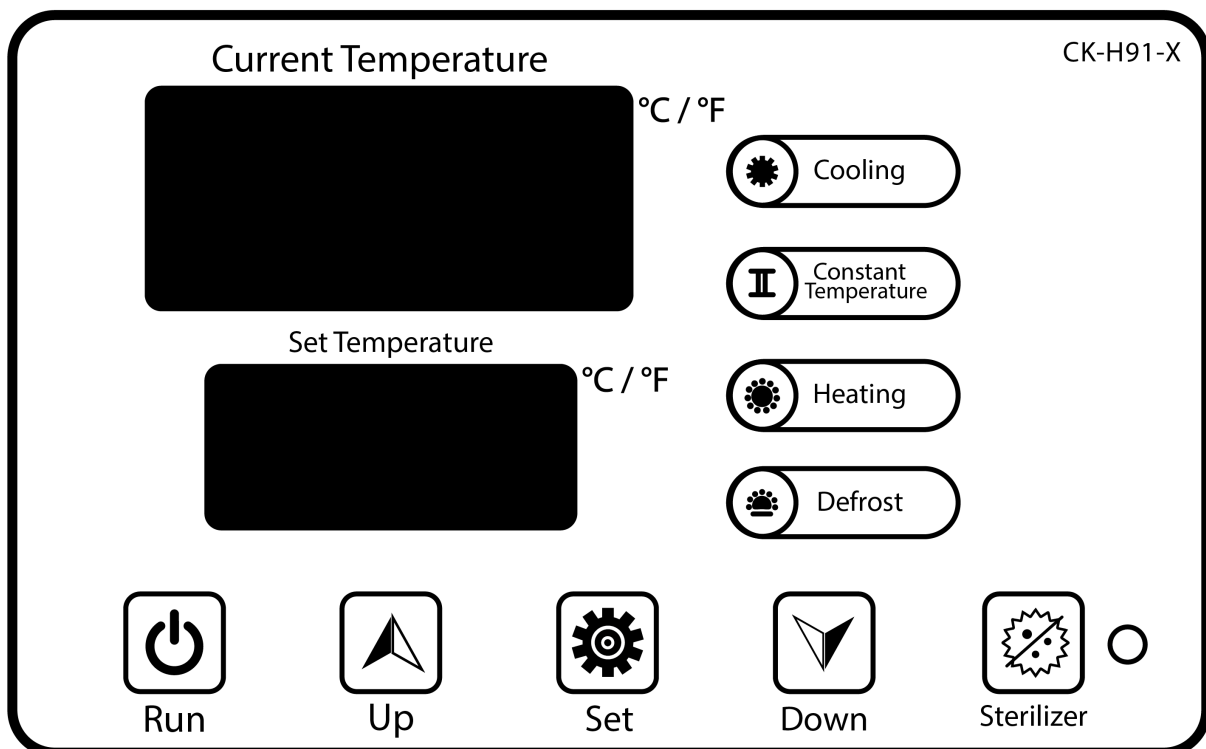



# Operational Instructions

1. Once the bath is filled with the desired amount of water, turn on the filter pump using the Run button. At this point check for any leakages from the piping. The ice bath should start when the time delay period has elapsed.

2. Press the **Set** button once and then using up or down buttons now select your desired temperature for the water to either chill or heat to.

When the ice bath has been running for a couple of minutes, check if the water arriving from the top pipe into the tub is hotter or colder than the water currently in the tub. If you are chilling the water coming out of the top pipe into the tub should feel colder.

3. Sterilizer button - This should only be used whilst the tub is not in use. Pressing this button will begin a 60 minute cycle of Ozone sterilisation. Please allow 1 hour to pass before using the bath after sterilisation.

4. Attached to your chiller is a 20 micron cartridge filter. For normal home use we recommend changing the filter every 3 months. You will find a wrench that can be used to unscrew the filter cartridge, now you can place the base of the filter in the clear plastic tube before fastening it back to the holder using the wrench. Check for leakage after reinstalling.

5. The ice bath and the filter pump should run 2 until the desired pool water temperature has been reached. Once the set temperature is reached, the ice bath will switch itself off. As long as the filter pump is running, the ice bath will restart automatically when the temperature of the pool water rises more than 1 degree below the set temperature.

Depending on the starting temperature of the water and the air temperature, it can take several hours for the water to reach the desired temperature. Covering the pool with the insulated jacket will reduce this period.

---

# Filter cleaning & replacement

The filter in your ice bath plays a crucial role in maintaining water cleanliness and should be attended to regularly:

**Domestic Use:** Clean filters weekly; replace them monthly.

**Commercial Use:** Clean filters daily; replace them weekly.

For new filters, please contact us to make arrangements.

## Changing the Filter: A Step-by-Step Guide

**Power off:** Ensure the ice bath and pump are turned off before proceeding.

**Locate the Filter:** You'll find the filter inside the chiller box.

**Unscrew the Filter Housing:** This is located at the top of the filter unit. It's normal for water to be inside the housing, so don't worry about spills during this step.

**Replace the Filter:** Gently pull out the old filter and dispose of it. Insert the new filter in its place.

**Reassemble:** Screw the filter housing back onto its attachment. Ensure it's tightly secured to prevent any leaks.

**Restart the System:** Turn the ice bath and pump back on. Check to ensure water is flowing through the new filter properly.

For any additional assistance or queries, please don't hesitate to contact us.

---





# Maintenance of your Bath

- Check the water inlet and drainage often. The water and air inflow into the system should be sufficient so that its performance and reliability does not get compromised. Clean the pool filter regularly to avoid damage to the ice bath caused by clogging of the filter.
- The area around the ice bath should be spacious and well ventilated. Clean the sides of the chiller regularly to maintain good heat exchange and to save energy.
- Check if all processes in the ice bath are operational and pay special attention to the operation pressure of the refrigerant system regularly.
- Check the power supply and cable connections regularly. Should the ice bath begin to function abnormally or should you notice a smell from an electrical component, contact us to arrange for an inspection, repair or replacement.
- We recommend that you change the water if the ice bath does not work for an extended period of time. You should check all parts of the ice bath thoroughly and fill the system with water before turning it on again to check the operation.

# Failure Codes

Code	Fault description	Cause of failure	Part that may have fault
E1	Water temperature probe failure	The water temperature probe is damaged or the probe is not properly installed	compressor, fan, four-way valve
E3	Water flow fault	Water shortage leads to no short circuit between the water flow detection port of the main board and the public	Water pump, compressor, fan, four-way valve
E4	Low voltage fault	The compressor pressure is too low, resulting in no short circuit between the low pressure detection port of the main board and the public	Compressor, fan, four-way valve
E5	High voltage fault	The compressor pressure is too high, resulting in no short circuit between the high-pressure detection port of the main board and the public	Compressor, fan, four-way valve
E6	Current overload	When the compressor is working, the current value exceeds the set value of F13	Compressor, fan, four-way valve
EH	Ultra high temperature fault	The temperature measured by the water temperature probe exceeds the set value of F11	Compressor, fan, four-way valve
EL	Ultra low temperature fault	The temperature measured by the water temperature probe exceeds the set value of F12	Compressor, fan, four-way valve
EE	Communication failure	Poor contact of communication interface and communication line to connector, or burning of communication chip	The system works normally
CCC	The equipment needs maintenance	The equipment has reached the set service life, please contact the engineer	All parts



# Installation Precautions

1. When connecting the water pipe between the bath body and the chiller, please ensure that the connection is secure and check if the sealing O-ring is intact (a new O-Ring needs to be replaced after removal)
2. The bath has a maximum capacity of 500L, and it is recommended to fill water to a level of 10cm from the top of the bucket. The minimum water amount before operation is above the inlet and outlet pipes inside the bucket.
3. Only use normal tap water to fill you bath.
4. Before draining water please check if the drainage pipe is properly installed.
5. When storing (please clean the bucket and cover it with a protective cover when not in use for a long time).
6. The Cedar wood of the barrel has a natural color difference, so please feel free to use it without any further treatment; Wipe off water with a wet towel that has been wrung dry; Do not use sharp and hard objects to avoid scratching the surface.
7. Ensure your hands are dry before touching electrical components and power plugs.
8. Your Chiller comes loaded with refrigerant Freon which may need to be replenished after normal use for 1-3 years, this is standard with all chillers.
9. The compressor has the same noise output of a standard house freezer. This noise is normal when in use.
10. The filter of the chiller needs to be replaced regularly, and it is recommended to replace it every 3 months.

# General Warnings to consider

Note: It is recommended that you have a waterproof plug socket installed.

The chiller should be turned on only when there is water in the tub covering both the top and bottom tubes. If the chiller is turned on without water it can cause irreversible damage to the chiller.

Freon refrigerant re-fills and future maintenance must be performed by a qualified professional.

Please refer to the machines for the amount of freon required for re-filling.

Sharp edges and coil surfaces are harmful and should be avoided

If the unit is not powered on for a long time, chilling with the outside environment with temps of  $\leq 0^{\circ}\text{C}$ , the water in the heat exchanger and water tank may freeze which can result in cracking.

Power supply should be set in 1.4 meters or above where children can not reach.

**WARNING: Do Not Inhale Ozone.** Move Immediately to a Fresh Air environment if exposed. Keep Out of Reach of Children.

**Hazards to Humans and Domestic Animals—Do Not Expose Children, People, Pets, Plants or Valuables to Ozone.**

Seek doctor's advice if exposed to ozone. Ozone half-life is 30 minutes. Areas where ozone generators are installed must be well-ventilated in case of accidental leakage.

This unit does not contain ozone. This unit produces ozone while running by creating oxygen in the air or an oxygen source to ozone. Use a deaerator and ozone destructor with the ozone generator.

Short term inhalation of high concentrations of ozone and long term inhalation of low concentrations of ozone can cause serious harmful physiological effects.

Do not inhale ozone gas produced by this device.

Disconnect all power to pool equipment prior to installation, maintenance, or removal of the Hydroxzone ozone Generator.

To avoid risk of electric shock, fire, or injury, servicing of the chiller should only be performed by a qualified pool service professional.

Installation must be performed in accordance with the National Electrical Code and any applicable local or state installation codes.

**NOTE:** The instructions in this document provide general installation guides. Consult your dealer for specific installation instructions.

Check system for any visible damage caused during shipping. If damage has occurred, contact the delivery company and your dealer immediately.

Before beginning installation, please verify that all listed parts are included.



# Name Plate & Wiring Diagram

Unit Model	CT12/CT13/CT14
Rated Cooling Capacity	2KW
Input Power Cooling	1KW
Running Current Cooling	10.5
EER	2.0
Noise @1meter	110V/1PH/60Hz
Water Connection	56dB(A)
Water Flow Volune	G1"
GWP Value	0.7m <sup>3</sup> /h
Refrigerant(R410A)	300g
GWP Value	2088
T of CO <sub>2</sub> equivalent	0.626

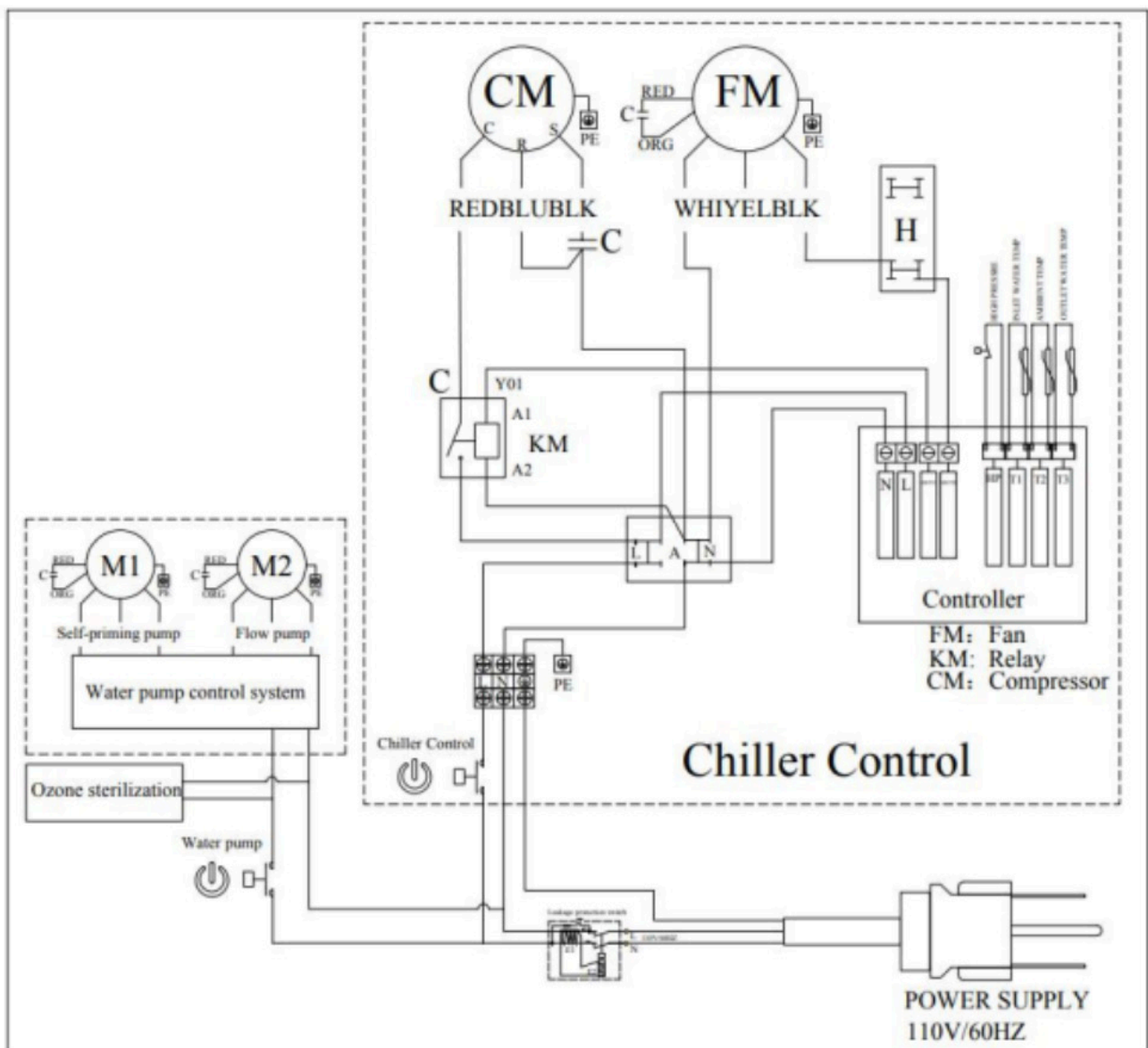

# Warranty

**Warranty Period:** 1 Year Warranty on chiller, 3 Year warranty on all other parts.

Kiva Wellness are the warranty providers for Kiva Wellness products. Kiva Wellness warranty this product to be free from defects in materials and workmanship while in normal commercial use for a period of five years on parts and labour from the original date of purchase.

Do not return your ice bath to the store you purchased from before contacting Kiva Wellness directly.

## **LOGGING A WARRANTY CLAIM**

Should you experience any issues with your product, please follow the below steps to lodge a warranty claim:

1. Contact Kiva Wellness and let them know the following details:
  - Your warranty details including name, email and phone number
  - Product name and model number
  - Explanation of how the damage occurred
  - Photos of the damage or issue is highly beneficial to expediting your claim
2. Kiva Wellness will assess your claim and respond within 24-48 hours. If the product exhibits a defect while in normal commercial use and within the warranty period; Kiva Wellness will either repair or replace the product or defective part free of charge.
3. In the event that the product is required to be sent to the service centre, the customer is required to pay for all packing, freight and insurance costs for transit of the product to Kiva Wellness. This is subject to the applicable consumer laws in your jurisdiction.
4. If the product, or one of its parts, qualifies for replacement or service within the 30-day period after the date of purchase, Kiva Wellness will arrange the shipping at no cost to you.
5. Any product sent to Kiva Wellness must include a return authorisation form that will be provided to you after your warranty claim is accepted. Failure to include this form may result in the product being rejected from the warehouse or a delayed service time.
6. In the event that the warranty period for a product has expired, or if a product does not qualify for warranty service, repair or replacement, customers can still buy replacement parts or have products repaired by one of the Kiva Wellness service centres. Please contact Kiva Wellness for further information. Kiva Wellness will contact you with a quote prior to undertaking any service work outside of the warranty coverage.
7. Typical turn-around times to address warranty claims can be between 10-14 business days, plus shipping, depending on location and type of damage or warranty claim.



8. In no event will the liability exceed the retail value of the product. We make no warranty with respect to parts, from a source other than Kiva Wellness warranty.

9. In the event that warranty parts or products are provided, the customer must cover the related shipping costs to receive goods.

10. All exchanged or substitute parts and products replaced under warranty service will become the property of Kiva Wellness. Repaired or replaced products or parts thereof will be warranted by Kiva Wellness for the balance of the original warranty period.

11. Kiva Wellness goods come with guarantees that cannot be excluded under the Australian Consumer Law. You are entitled to a replacement or refund for a major failure and compensation for any other reasonably foreseeable loss or damage. You are also entitled to have the goods repaired or replaced if the goods fail to be of acceptable quality and the failure does not amount to a major failure.

#### **WARRANTY DOES NOT COVER**

1. Damage, accidental or otherwise, to the product, not caused by a direct defect in factory workmanship or materials.

2. Damage due to abuse, mishandling, alteration, misuse, commercial service, tampering, accident, failure to follow the care, operating and handling provisions indicated in the instructions.

3. Damage caused by parts or services not authorised or performed by Kiva Wellness.

4. 'Normal' wear and tear that naturally and inevitably occurs as a result of normal use or ageing.

5. Some states do not allow the exclusion or limitation of incidental or consequential damages. Therefore, the above limitations may not apply to you in the case of damage in shipment. If your product was damaged in shipment: Immediately report this type of damage to the parcel carrier and have them file an inspection report to contact the distributor from whom you purchased the product for further instructions.



6. You have rights and benefits under the consumer laws in your jurisdiction. Without detracting from these rights or benefits, Kiva Wellness excludes all liability in respect of this product for any other loss which is not reasonably foreseeable from a failure of this product, which may include liability for negligence, loss of expenditure associated with the product and loss of enjoyment.

# KIVA WELLNESS

ELEVATE YOUR WELLNESS & RECOVERY

[KIVAWELLNESS.COM.AU](http://KIVAWELLNESS.COM.AU)

07 4270 8000

@kivawellness   

Kiva Wellness products should not be considered medical devices, and should be treated as general wellness products only. Our product range has not been designed to prevent or treat medical conditions, and we recommend you consult a health practitioner if you are unsure about whether a Kiva Wellness product is suitable for you.