

## INSTALLATION MANUAL

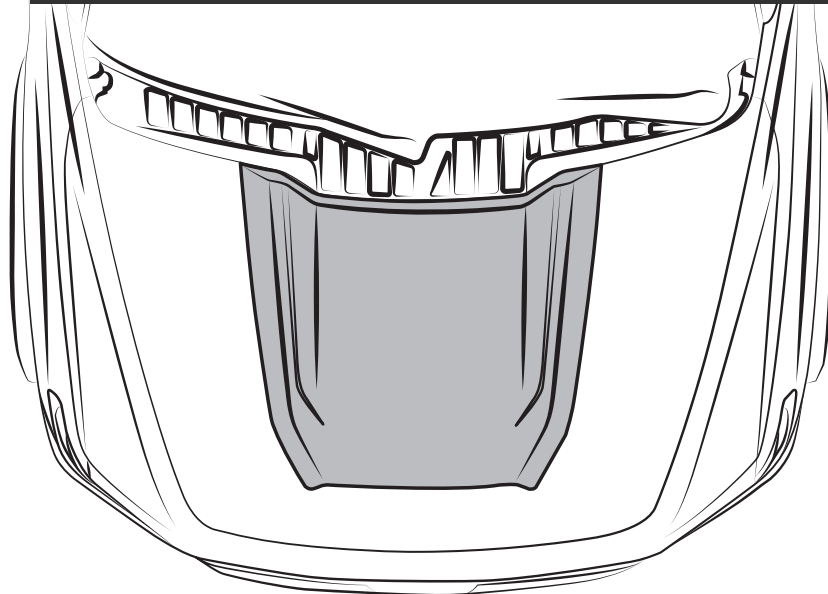

**! READ THIS MANUAL CAREFULLY**

**PART NUMBER: FO31A01**

### BEFORE INSTALLING



**WASH & CLEAN  
PROPERLY**



**WE RECOMMEND  
2 PERSONS FOR  
INSTALLATION**

### AFTER INSTALLING



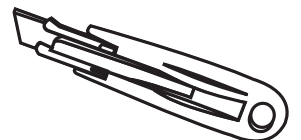
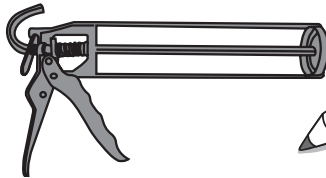

**DO NOT WASH  
IN 48 HRS**

### TOOLS



### CHECK LIST

**\*ALREADY INSTALLED ON THE PART**

ITEM	DESCRIPTION	DRAWING	AMOUNT
A	*VHB TAPE		N/A
B	POLYURETHANE ADHESIVE 310 ml.		1 PC

### **! WARNING!**

Do not install Hood Scoops or other Body Parts directly Over Wrapped areas. Before installation of the parts, you must leave at least a 1/4" (6 mm) perimetral clearance "Free from Vinyl" surrounding the part, before Part installation.

Do not install Hood Scoops Over Vinyl or Over Plastic Stripes on the Hood: 3M Adhesive Tape and

PUR Adhesive must always be in contact with the Sheet Metal of the vehicle.

Rust Prevention Oils and other Petrol Based Anti Rust Treatments for Vehicles may affect 3M's Double Adhesive Tape and Polyurethane Adhesive performance!

# HOOD SCOOP WITH GRILLE

PART NUMBER: FO31A01



THE IDEAL TEMPERATURE RANGE OF THE PART AND THE VEHICLE WHEN INSTALLING MUST BE 16°C (60°F) TO 40°C (104°F), THIS GUARANTEES A CORRECT ASSEMBLY.

## 1 CLEAN



REMOVE ANY DETERGENT, WAX OR DETAILING RESIDUE

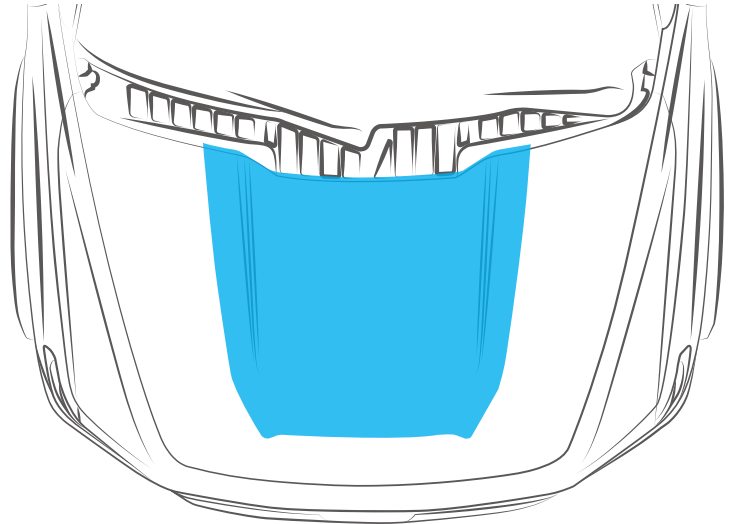

## 2 TEST FIT THE PART

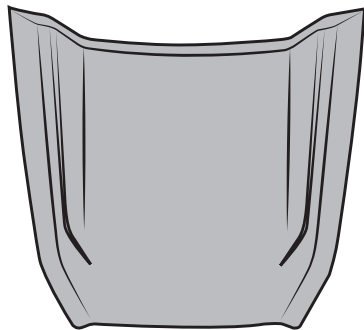

ALIGN AND CENTER

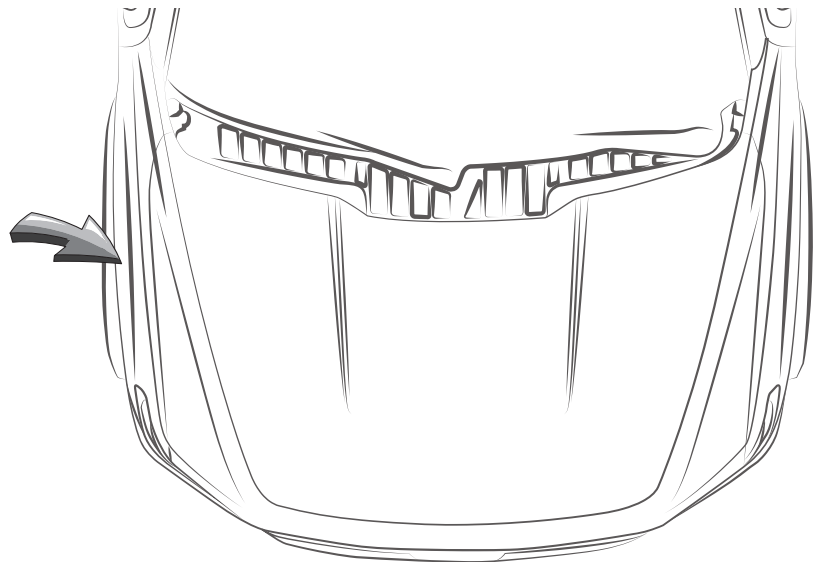

## 3 MARK



DRAW HASH MARK WITH GREASE PENCIL ON HOOD SCOOP AND SHEET METAL, THIS WILL ENSURE HOOD SCOOP WILL BE CENTERED TO GREASE PENCIL OUTLINE.



HASH MARKS

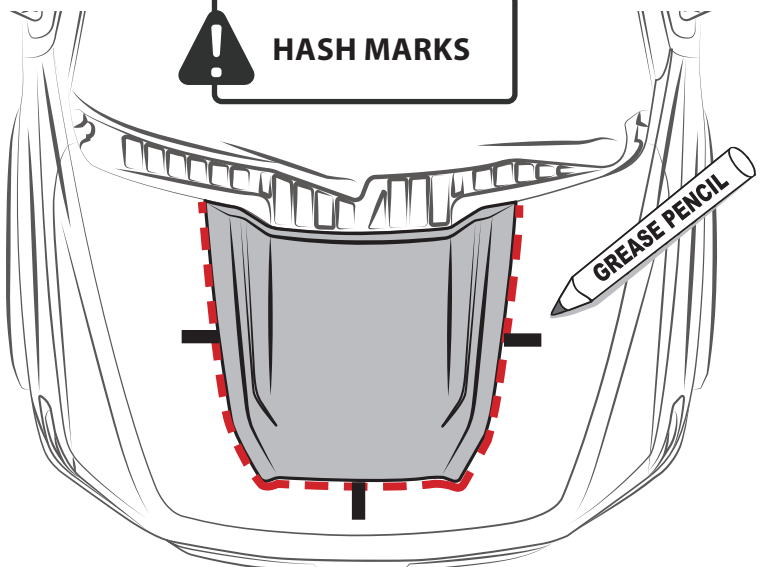

**4 REMOVE**

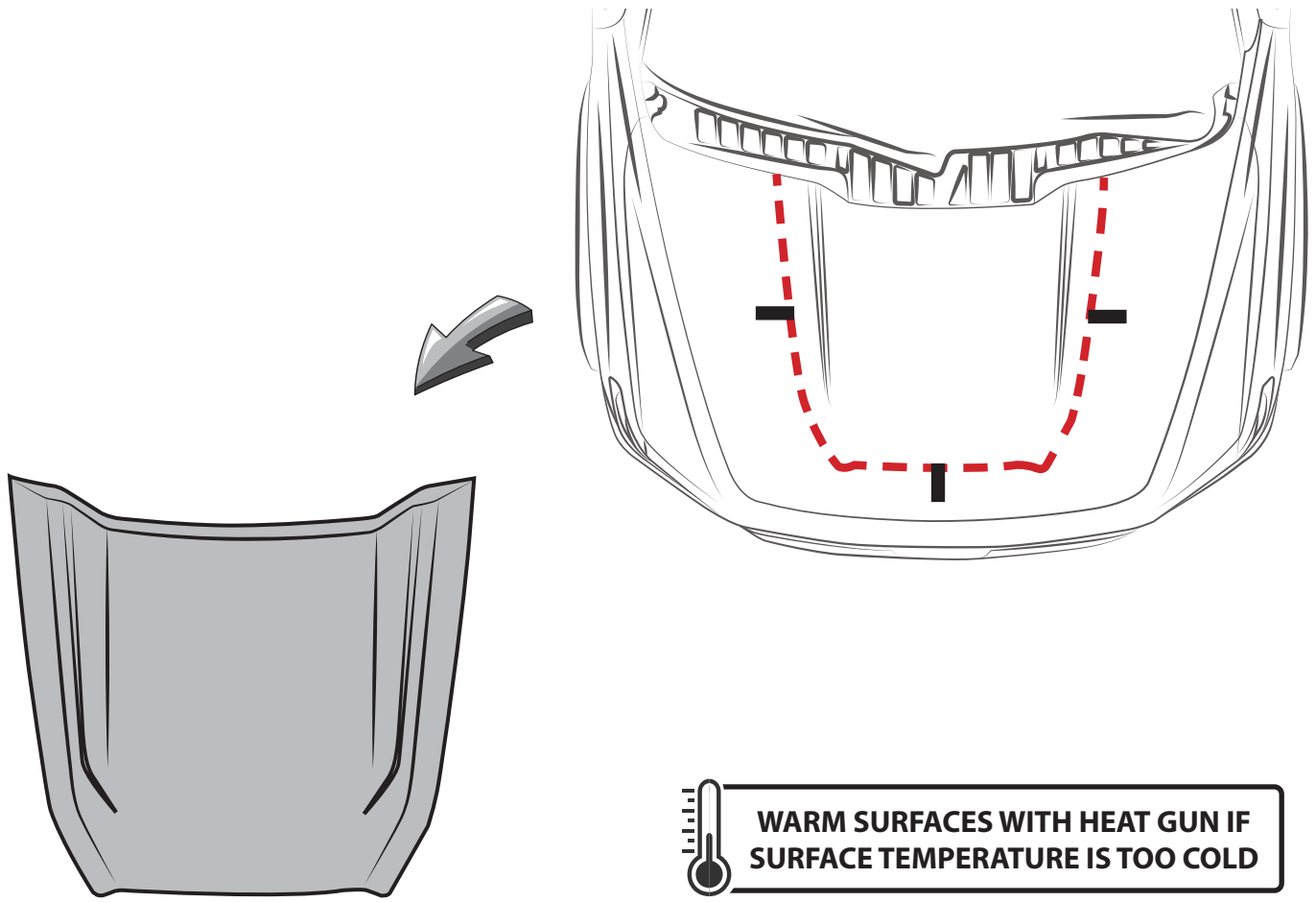

**5 CLEAN THE ADHESIVE CHANNEL**

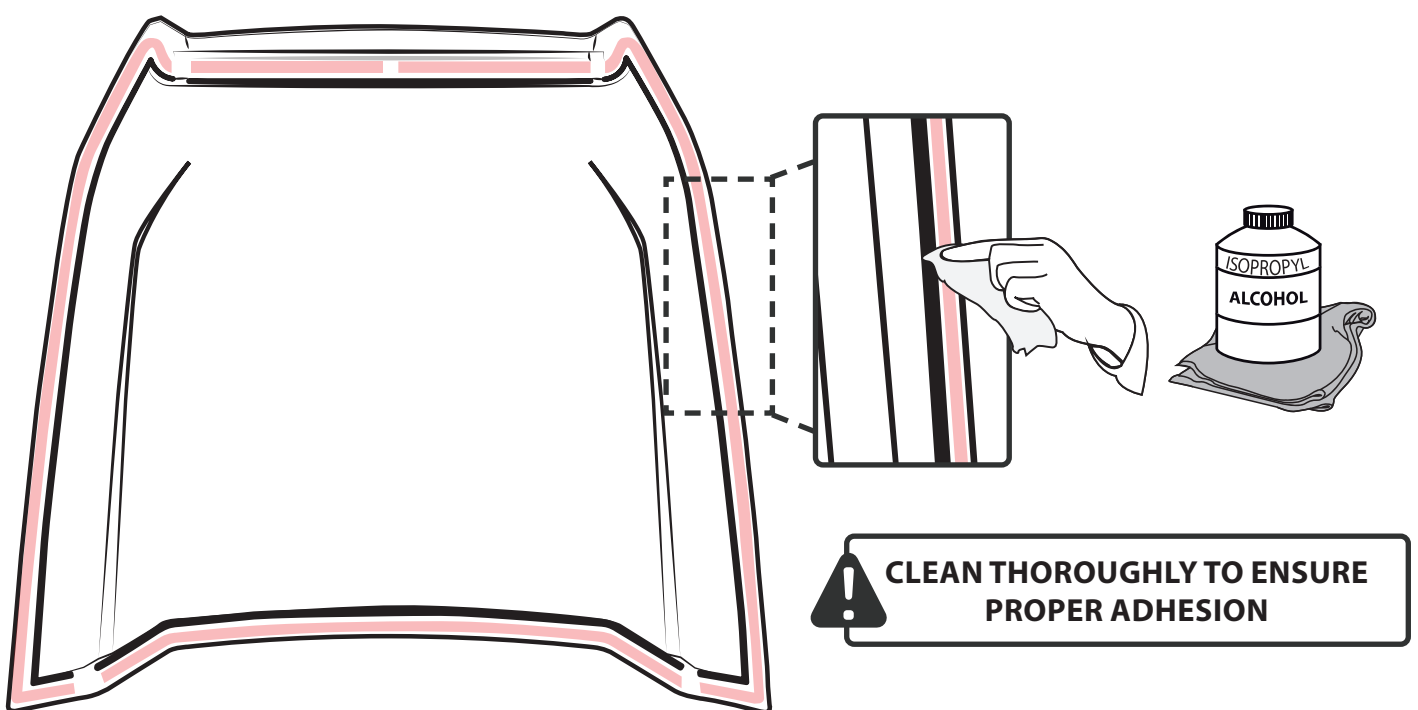

# HOOD SCOOP WITH GRILLE

PART NUMBER: FO31A01

## 6 PEEL

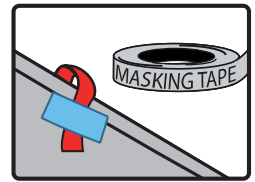
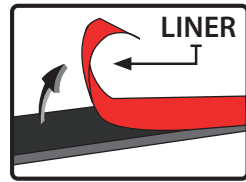

**! STICK THE LINER LEAD ON THE OUTSIDE OF THE PART**

## 7 APPLY POLYURETHANE ADHESIVE

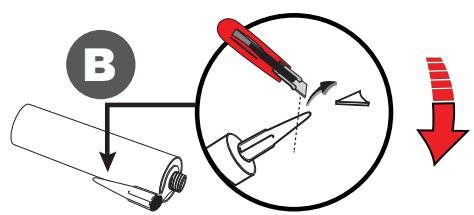

**! POLYURETHANE ADHESIVE MUST NEVER TOUCH DOUBLE SIDED TAPE**

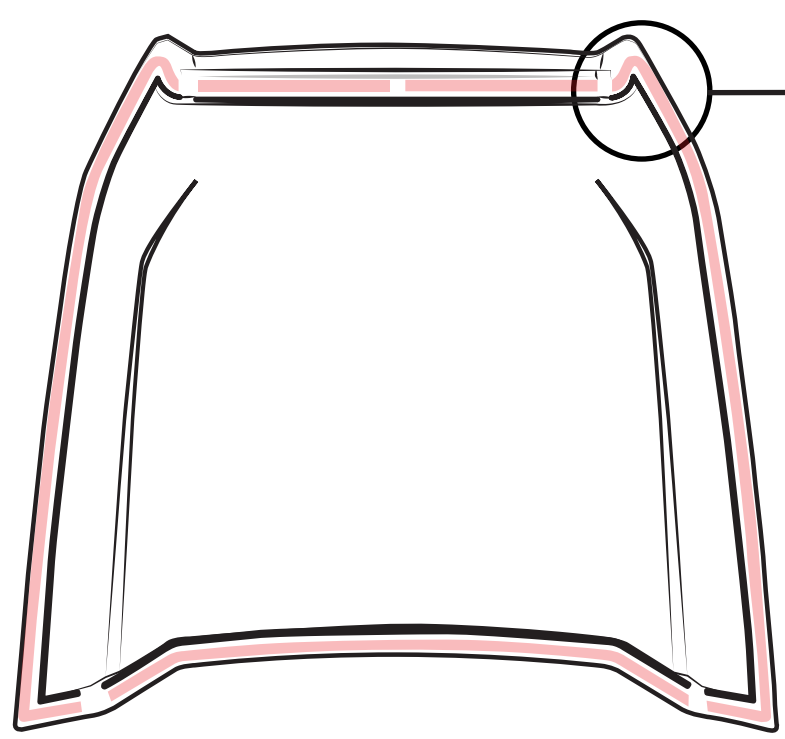
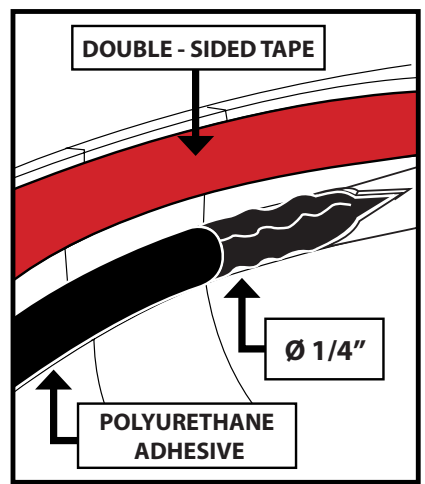

**WATER DRAIN  
KEEP OPEN WITHOUT  
ADHESIVE**

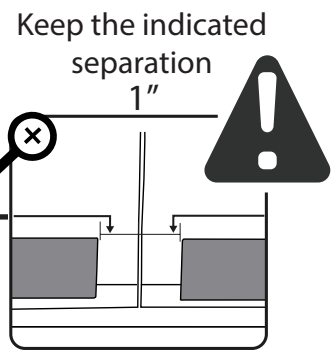

**8** PLACE

**!** ALIGN WITH MARKINGS

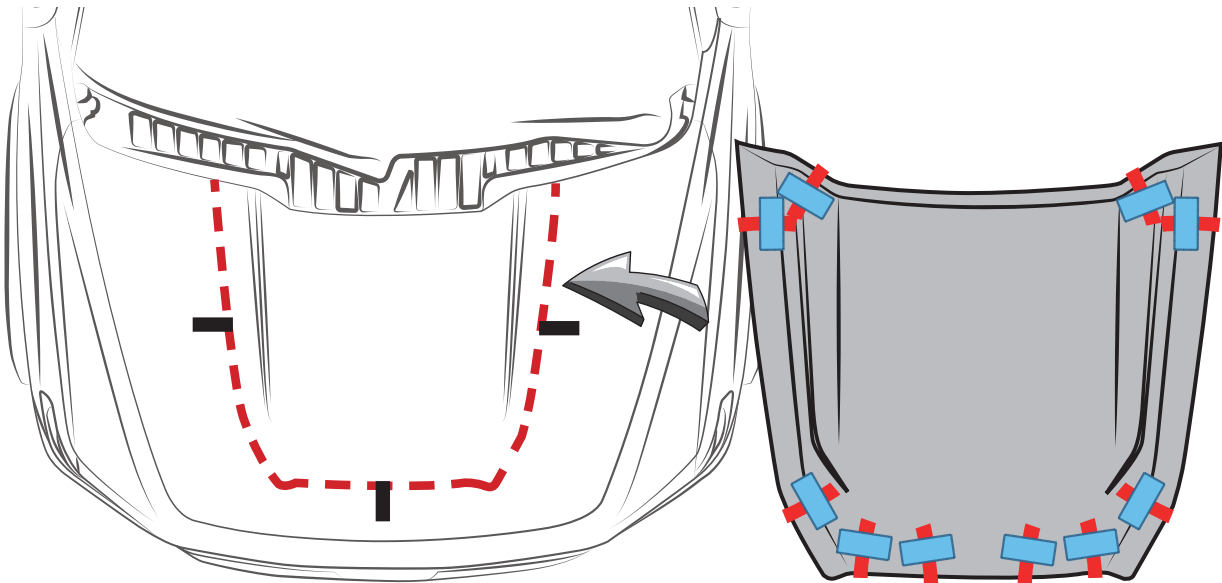

**9** REMOVE LINER

**!** APPLY LIGHT PRESSURE BEHIND LINER AS IT IS REMOVED TO ADHERE THE TAPE TO THE VEHICLE SURFACE

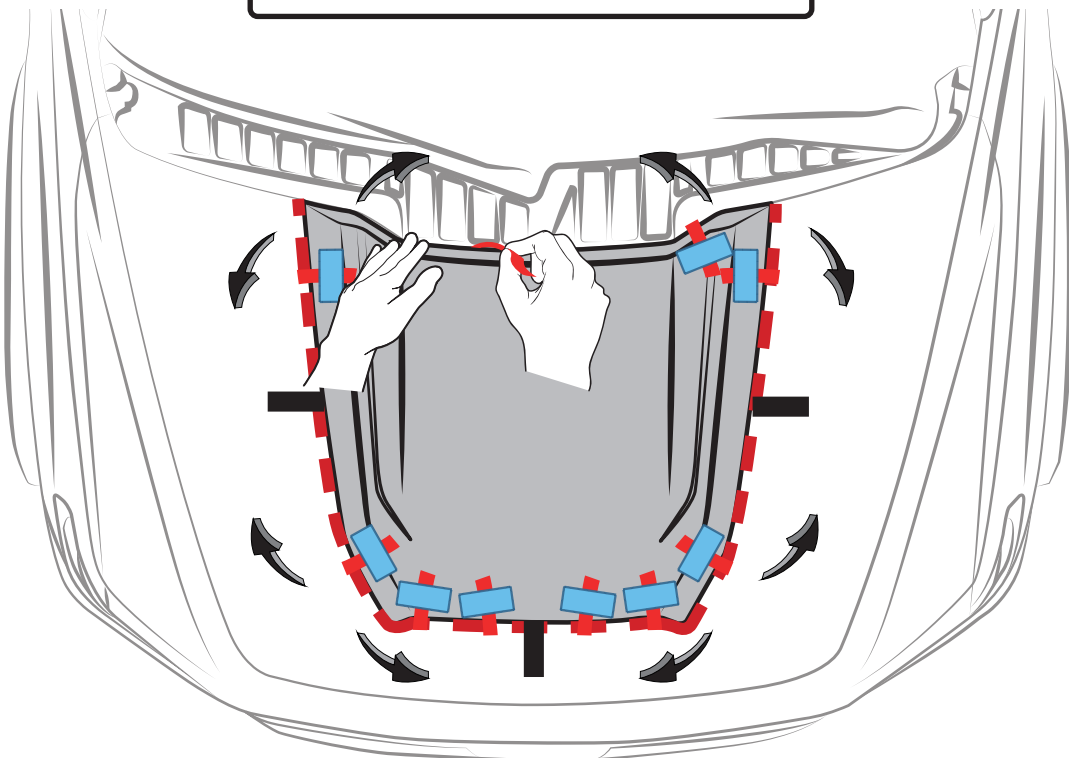

# HOOD SCOOP WITH GRILLE

PART NUMBER: FO31A01

## 10 PRESS FIRMLY

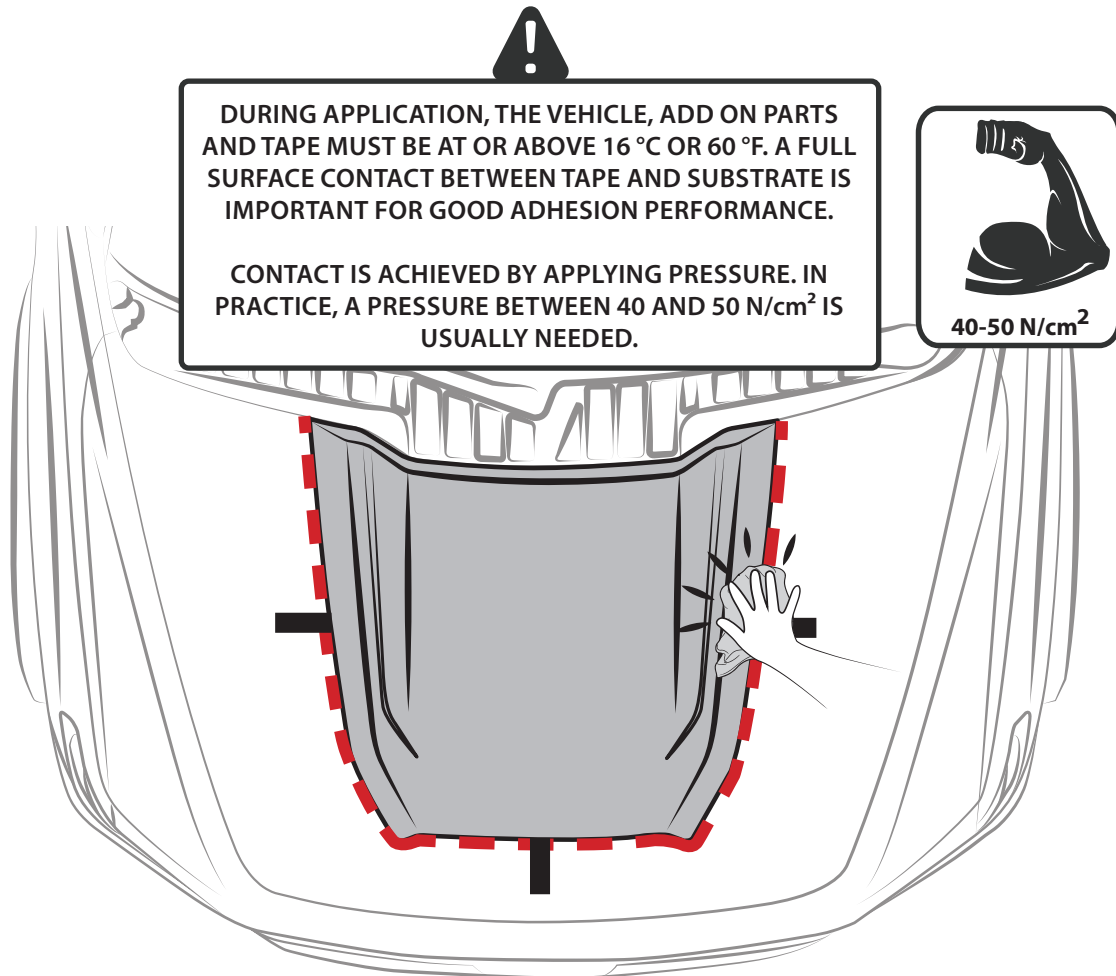

## 11 CLEAN

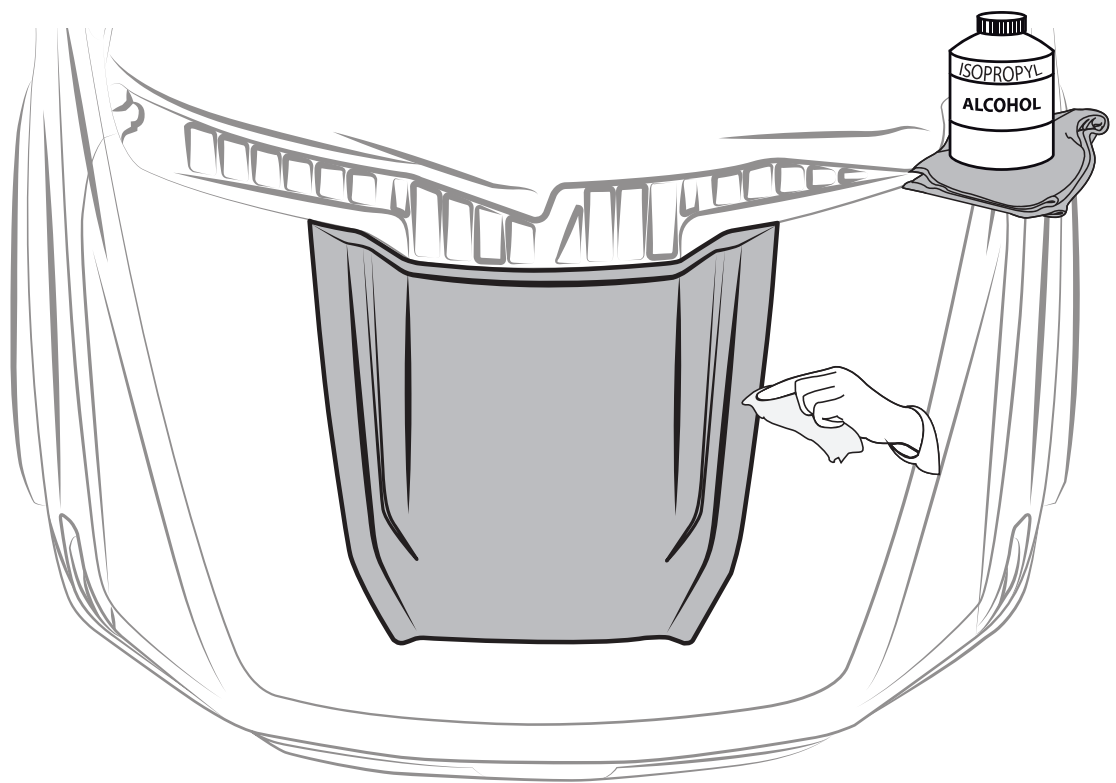

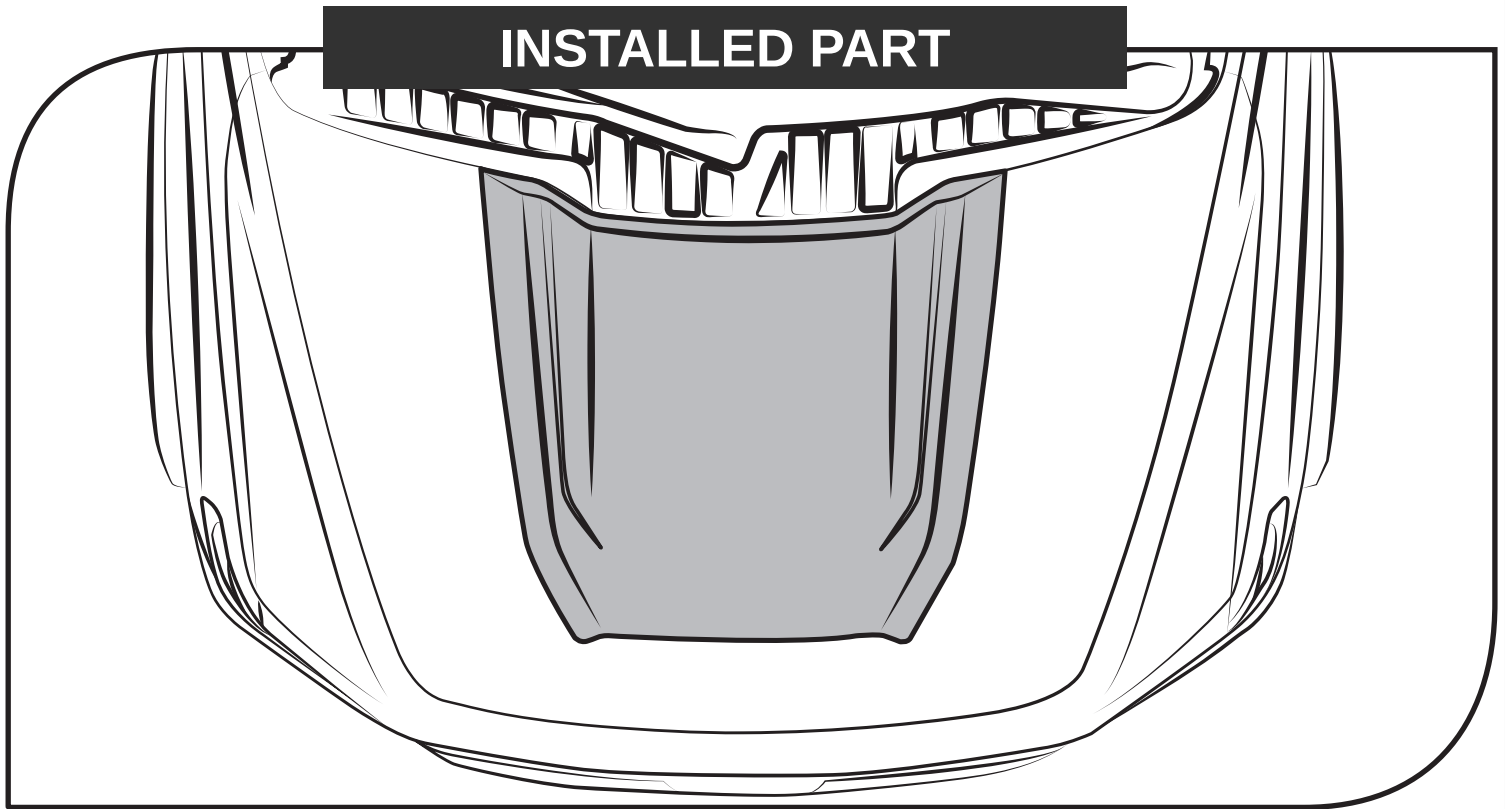

**! WARNING!**

**Do not install Hood Scoops or other Body Parts directly Over Wrapped areas. Before installation of the parts , you must leave at least a 1/4" (6 mm) perimetral clearance "Free from Vinyl" surrounding the part, before Part installation.**

**Do not install Hood Scoops Over Vinyl or Over Plastic Stripes on the Hood: 3M Adhesive Tape and**

**PUR Adhesive must always be in contact with the Sheet Metal of the vehicle.**

**Rust Prevention Oils and other Petrol Based Anti Rust Treatments for Vehicles may affect 3M's Double Adhesive Tape and Polyurethane Adhesive performance!**

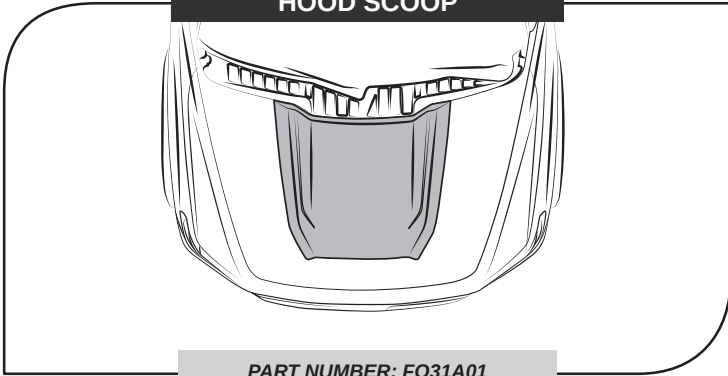
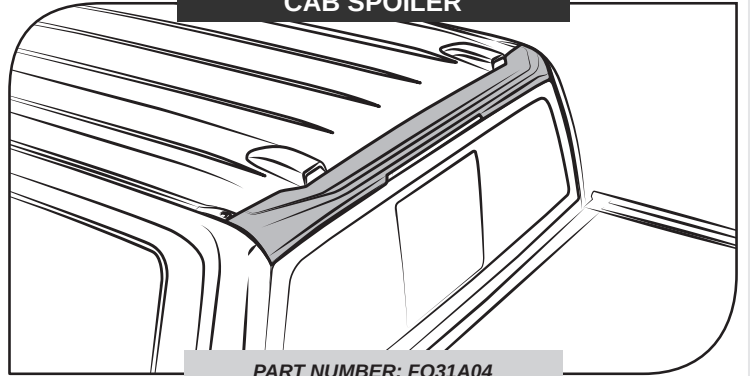
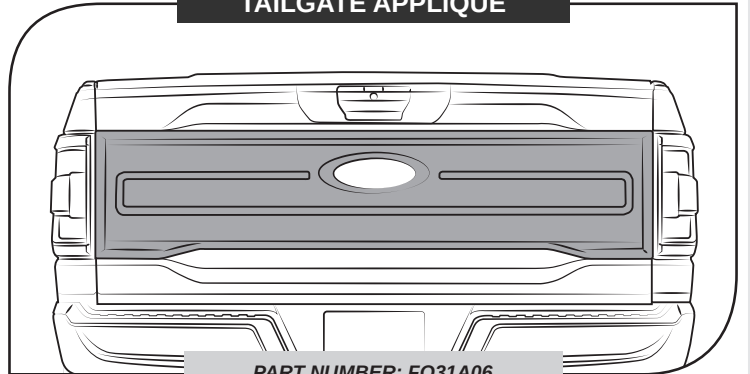
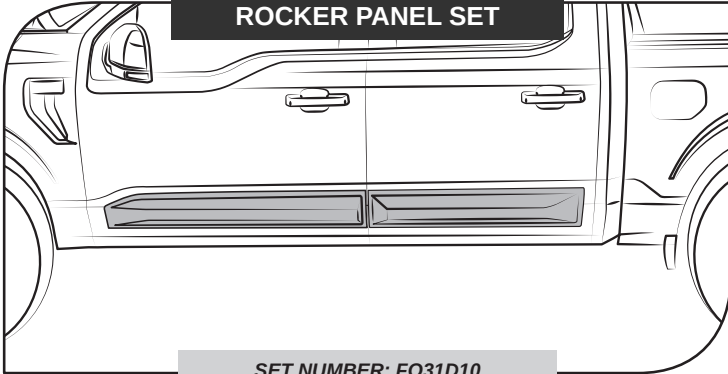
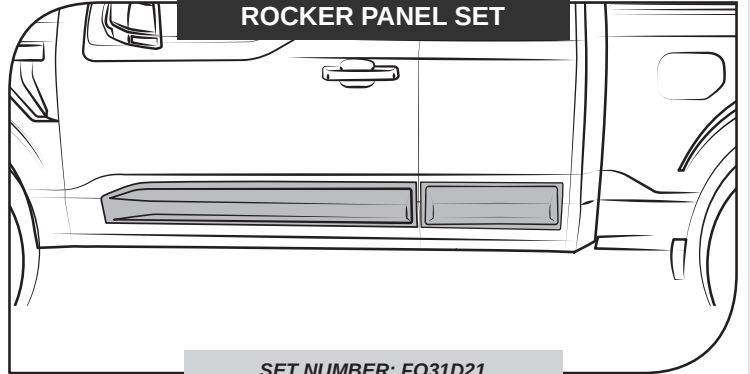
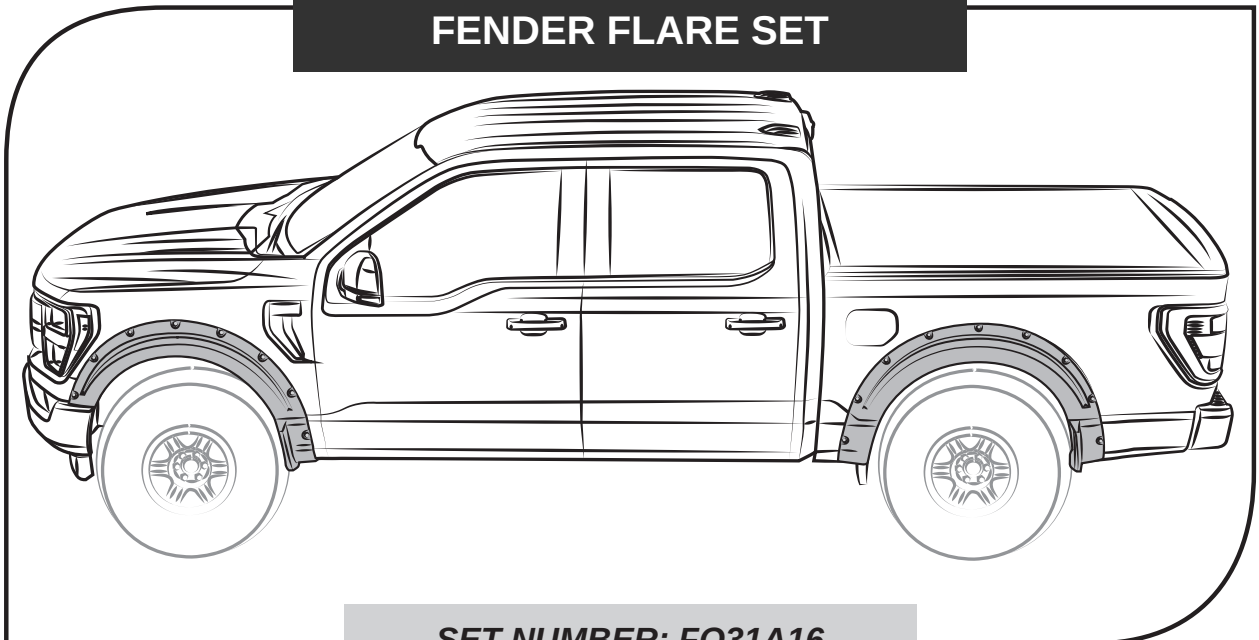
**BODY KIT OFF ROAD****HOOD SCOOP****PART NUMBER: FO31A01****CAB SPOILER****PART NUMBER: FO31A04****TAILGATE SPOILER****PART NUMBER: FO31A05****TAILGATE APPLIQUE****PART NUMBER: FO31A06****CREW CAB DOOR  
ROCKER PANEL SET****SET NUMBER: FO31D10****SUPER CAB DOOR  
ROCKER PANEL SET****SET NUMBER: FO31D21****AIR DESIGN SUPER BOLTS  
FENDER FLARE SET****SET NUMBER: FO31A16**