

NucleoCounter[®] YC-100[™]

User's Guide

Revision 1.3



Technology that counts





This page was intentionally left blank

NucleoCounter[®] YC-100[™]

Yeast Cell Counter

P/N 991-0300 (English)

Revision 1.2

December, 2005



ChemoMetec A/S

Gydevang 43, DK-3450 Allerød, Denmark

Telephone: (+45) 48 13 10 20, Fax: (+45) 48 13 10 21

Internet: www.chemometec.com,

E-mail: info@chemometec.com

This page was intentionally left blank

Caution!

This equipment must be operated as described in this User's Guide. Please read the entire guide before attempting to use this unit. Please pay attention to that gloves or protective clothing are not worn on the illustrations/pictures shown in this User's Guide. However, ChemoMetec A/S does recommend that the user wear suitable protective clothing etc.

Contacting support

Technical information including product literature, answers to questions regarding the operation of the NucleoCounter® YC-100™ not covered in this document and information on software upgrade is available through the following:

- For e-mail support, send questions to NucleoCounter® YC-100™ Technical Support on the address **support@chemometec.com**
- To speak with a Technical Support Specialist, call (+45) 48 13 10 20.

Please note the NucleoCounter® YC-100™ serial number and have it available when contacting ChemoMetec A/S for support. The NucleoCounter® YC-100™ serial number is found on the label affixed to the bottom of the instrument and in the display upon start-up.

Sales and ordering information

For sales assistance with NucleoCounter® YC-100™ or the NucleoView™ software, to place an order for a NucleoCounter® YC-100™ or consumables, call (+45) 48 13 10 20, fax (+45) 48 13 10 21, or send e-mail to **sales@chemometec.com**

Disclaimer Notices

The material in this document is for information only and is subject to change without notice. While reasonable efforts have been made in the preparation of this document to assure its accuracy, ChemoMetec A/S assumes no liability resulting from errors or omissions in this document, or from the use of the information contained herein.

ChemoMetec A/S reserves the right to make changes in the product design without reservation and without notification to its users.

Copyright Notices

Copyright © ChemoMetec A/S 2005. All rights reserved. No part of this publication may be reproduced, stored in a retrieval system, or transmitted in any form or by any means, electronic, mechanical, photocopying, recording or otherwise, without the prior written consent of ChemoMetec A/S, Gydevang 43, DK-3450 Allerød, Denmark.

ChemoMetec and NucleoCounter are registered trademarks owned by ChemoMetec A/S. NucleoCounter, NucleoCassettes, Reagent Y100 and NucleoView are trademarks of ChemoMetec A/S.

All other trademarks are the property of their respective owners.



This page was intentionally left blank

Declaration of Conformity

Name of product: NucleoCounter®
Type: YC-100

Other identifying data: Part no. 900-0300

The product complies with requirements of the following directives:

89/336/EEC - Electromagnetic Compatibility (EMC)

89/392/EEC - Machinery Directive

Harmonized standards, which have been used:

EN61326: 1997+A1: 1998 (Class B) +A2: 2000, Electrical equipment for measurement, control and laboratory use – EMC requirements (emission and immunity). Annex B and C from A1: 1998 is used.

This device complies with Part 15 of the FCC Rules. Operation is subject to the following two conditions: (1) this device may not cause harmful interference, and (2) this device must accept any interference received, including interference that may cause undesired operation.

Date: 2005-11-04

Signed:

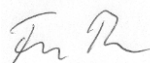

Name: Frans Ravn

Position: Chief Technology Officer

Name and address of manufacturer:

ChemoMetec A/S
Gydevang 43
DK-3450 Allerød
DENMARK



This page was intentionally left blank

WEEE directive information – Europe only

Correct Disposal of This Product (Waste Electrical & Electronic Equipment) - Europe only

This marking shown on the product or its literature, indicates that it should not be disposed together with other household wastes at the end of its working life. To prevent possible harm to the environment or human health from uncontrolled waste disposal, please separate this from other types of wastes and recycle it responsibly to promote the sustainable reuse of material resources.

Business users should contact their supplier and check the terms and conditions of the purchase contract. This product should not be mixed with other commercial wastes for disposal.

This information is listed in “Appendix 1: WEEE directive information in more EU languages”.

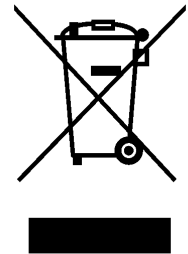



This page was intentionally left blank

Introduction and intended use

The NucleoCounter YC-100 is intended to be used for the determination of yeast cell concentration in sample containing dispersed yeast cells in suspension.

The NucleoCounter YC-100 has been developed to count dispersed yeast cells in suspension

The instrument is a part of the NucleoCounter YC-100 system, which also comprises a disposable NucleoCassette and a lysis buffer (Reagent Y100).

The NucleoCounter YC-100 system allows reliable, fast and objective cell counting to be carried out based on an automated method of fluorescence microscopy. The system enables the user to stain and count cells with good protection against being exposed to potentially hazardous DNA staining dyes.

The NucleoCounter YC-100 is developed as a stand-alone instrument but optionally it can be connected to a computer via an USB-interface. When connected to a computer the NucleoView software offers various features such as documentation of the obtained results. For further description of the software please refer to the NucleoView User's Guide.

The NucleoCounter YC-100 has the ChemoMetec part number 900-0300. Refer to section 10.1 with respect to other part numbers of the items of the NucleoCounter YC-100 system.

The NucleoCounter YC-100 system is not intended for human or veterinary diagnostic purposes.

This page was intentionally left blank

Warnings and precautions

Wherever the  symbol appears on the NucleoCounter instrument, it indicates that the manual must be consulted for precautions and warnings.

Power and cables

Use the shielded USB cable supplied with the NucleoCounter to ensure that you maintain the appropriate EMI classification for the intended environment.



 The USB interface connector of the NucleoCounter must only be connected to SELV circuits. External computing devices connected to the USB interface connector of the NucleoCounter has to comply with the standards, UL 1950 and IEC/EN 60950.

Table 1. Description of the NucleoCounter USB interface connector

Pin no.	Name	Maximum Voltage level ¹
1	+5V	+5VDC
2	D-	+3.5VDC
3	D+	+3.5VDC
4	DGND	0VDC
Metal enclosure	Shield (connected to DGND)	0VDC

Use the shielded printer cable supplied with the NucleoCounter to ensure that you maintain the appropriate EMI classification for the intended environment.

 The printer interface connector of the NucleoCounter must only be connected to the printer supplied by ChemoMetec A/S. External computing devices connected to the printer interface connector of the NucleoCounter has to comply with the standards, UL 1950 and IEC/EN 60950.

¹ In normal operation mode (refers to Pin no 4)

Table 2 Description of the NucleoCounter Printer Output connector

Pin no	Name	Maximum Voltage level ²
1 ³		
2	Rx	±10 VDC
3	Tx	±10 VDC
Metal Enclosure	DGND	0 VDC

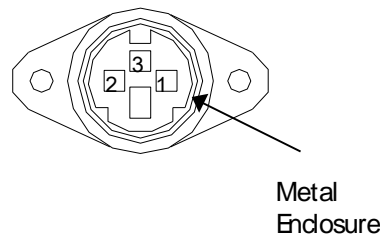

Figure 1 Printer Output connector seen from the cable entry side.

NucleoCounter is powered by an external 12VDC power supply. For safe use, please follow the instructions for connecting the power supply.

⚠ The NucleoCounter shall only be used with one of the following external power supplies:

- Power supply Class I, Proton Electronic Industrial Co. Ltd., model SPN-260-12, input rated 100-240 Vac, 50-60Hz, 1.6 A. Output rated 12 Vdc, 4.3 A.
- Power Supply Class I, Powerbox Europe AB, model EBH 03 131, input rated 100-240 Vac, 47-63 Hz, 0.8A. Output rated 11-13 Vdc, 2.7 A.
- Power supply Class II, Celetron USA Inc., model ZVC40LT12E, input rated 100-240 Vac, 50-60Hz, 1.2 A. Output rated 12 Vdc, 3.3 A.

⚠ The detachable power supply cord set and appliance inlet of the external power supply are considered as the disconnecting device.

⚠ The mains supply cord and plug of the external power supply shall comply with any national regulations.

² In normal operation. Refers to DGND Metal Enclosure. Taken from the datasheet for MAX202ECSE.

³ There is no signal connected to pin 1.

⚠ The user shall be made aware of that, if the NucleoCounter and the external power supply is used in a manner not specified by the manufacturer, the protection provided by the NucleoCounter and the external power supply may be impaired.

Electromagnetic interference

NOTE: This equipment has been tested and found to comply with the limits for a Class B digital device, pursuant to Part 15 of the FCC Rules. These limits are designed to provide reasonable protection against harmful interference in a residential installation. This equipment generates, uses and can radiate radio frequency energy and, if not installed and used in accordance with the instructions, may cause harmful interference to radio communications. However, there is no guarantee that interference will not occur in a particular installation. If this equipment does cause harmful interference to radio or television reception, which can be determined by turning the equipment off and on, the user is encouraged to try to correct the interference by one or more of the following measures:

- Reorient or relocate the receiving antenna.
- Increase the separation between the equipment and receiver.
- Connect the equipment to an outlet on a circuit different from that to which the receiver is connected.
- Consult the dealer or an experienced radio/TV technician for help.

Caution! Changes or modifications not expressly approved by the party responsible for compliance could void the user's authority to operate the equipment.

Cassettes, Reagents and Dispensers

With respect to usage and handling of cassettes, lysis buffers and dispensers, please refer to appropriate package inserts for these items.

Caution! When using a bottle-top dispenser: To protect against accidental splashes protective clothing, eye protection and gloves must be worn when using potentially hazardous liquids.

General

Any biological specimen should be handled as if it is capable of transmitting infectious disease and disposed of with proper precautions according with federal, state and local regulations.

Avoid specimen contact with skin or mucous membranes.

Never pipette by mouth.

Avoid cross contamination of the samples when preparing of the samples. This can compromise the quality of the results.

Table of contents

DECLARATION OF CONFORMITY	VI
WEEE DIRECTIVE INFORMATION – EUROPE ONLY	VIII
INTRODUCTION AND INTENDED USE	X
WARNINGS AND PRECAUTIONS.....	1
1 INSPECTION AND UNPACKING OF EQUIPMENT	7
2 INTRODUCING THE NUCLEOCOUNTER YC-100	9
2.1 THE NUCLEOCOUNTER YC-100 INSTRUMENT.....	9
2.1.1 <i>Fluorescence microscope</i>	10
2.1.2 <i>Built-in image analysis</i>	11
2.2 THE NUCLEOCASSETTE	11
2.2.1 <i>Loading the cassette</i>	12
2.2.2 <i>Fluorescent dye</i>	12
2.2.3 <i>Sample volume</i>	12
2.2.4 <i>Cassette handling</i>	13
2.3 LYSIS BUFFER.....	13
3 CONTROL BUTTONS, KEYPAD AND DISPLAY	15
3.1 INTERACTIVE CONTROLS	15
3.1.1 <i>Control Buttons</i>	15
3.1.2 <i>Keypad</i>	15
3.2 INTERFACE DISPLAY	16
3.2.1 <i>Status indicator</i>	16
3.2.2 <i>Display screen</i>	16
4 INSTALLATION AND START-UP	17
4.1 POWER ON, POWER OFF	17
4.1.1 <i>Starting up</i>	17
4.1.2 <i>Shutting down</i>	18
4.2 INSTALLATION OF NUCLEOVIEW	18
5 OPERATION OF THE NUCLEOCOUNTER YC-100	19
5.1 READY MODE.....	19
5.2 INSERTING AND REMOVING THE CASSETTE	19
5.2.1 <i>Protection of the optical system</i>	19
5.2.2 <i>Inserting cassette</i>	19
5.3 MEASURING - THE RUN BUTTON.....	20
5.3.1 <i>Actuator movements</i>	20
5.3.2 <i>Result presentation</i>	20
5.3.3 <i>External computer</i>	21
5.4 RESULT DISPLAY	21

5.4.1	<i>Result mode</i>	21
5.4.2	<i>Saving parameters</i>	22
5.4.3	<i>Setting Date (F200) and Time (F201)</i>	22
5.4.4	<i>Reset Counter (F30)</i>	22
5.4.5	<i>LCD contrast (F220)</i>	22
5.4.6	<i>Instrument Info (F100)</i>	23
5.5	INSTRUMENT SENSITIVITY (F11).....	23
5.6	ZERO COUNT CHECK (F50)	24
6	TOTAL AND VIABILITY COUNT	27
6.1	NON-VIABLE CELL CONCENTRATION	27
6.2	TOTAL CELL CONCENTRATION	27
6.3	DETERMINATION OF VIABILITY	28
7	MAINTENANCE OF NUCLEOCOUNTER YC-100	29
7.1	CLEANING	29
7.1.1	<i>Cassette insertion area</i>	29
7.1.2	<i>Optical elements</i>	29
7.1.3	<i>Removal of dust particles</i>	30
7.1.4	<i>Spill of liquid</i>	31
8	TROUBLESHOOTING - ERROR MESSAGES.....	33
8.1	NO VALID CASSETTE	33
8.2	ANALYSIS ABORTED	33
8.3	ACTUATOR ERROR MESSAGES.....	34
8.4	SAMPLE COULD NOT BE ANALYZED	34
8.5	SENSOR ERROR	34
8.6	POWER-ON FAILURE	35
9	TECHNICAL SPECIFICATIONS.....	37
9.1	TECHNICAL SPECIFICATIONS FOR NUCLEOCOUNTER YC-100	37
9.2	THE NUCLEOCASSETTE™	38
9.3	EMC/EMI STANDARDS.....	38
10	EQUIPMENT AND ACCESSORIES	38
10.1	EQUIPMENT AND ACCESSORIES LIST.....	38
10.2	POWER SUPPLY	40
10.3	MAINS POWER CORD	40
10.4	DRY COMPRESSED AIR	41
10.5	EXTERNAL PRINTER (OPTIONAL).....	42
11	APPENDIX 1: WEEE DIRECTIVE INFORMATION IN MORE EU LANGUAGES	

1 Inspection and Unpacking of Equipment

Upon receiving the order from ChemoMetec A/S, the box or boxes should be carefully inspected for any damage that may have occurred during shipping. Any damage must be reported to the carrier and to ChemoMetec A/S immediately.

Unpack the order, saving the packing materials for possible later use. Also be sure to save the User's Guide, for instruction and reference.

Verify the ChemoMetec packing list received refers to the correct and ordered materials, and that nothing is missing.

If any part of the order was damaged during shipping or is missing, or fails to operate, please contact ChemoMetec A/S.

This page was intentionally left blank

2 Introducing the NucleoCounter YC-100

The NucleoCounter method provides a fast alternative to the manual techniques, yielding objective and reliable results. Furthermore the NucleoCounter technology provides improved safety to the user compared to other comparable methods.

The NucleoCounter system is comprised of the NucleoCassette for sample handling, the NucleoCounter instrument for particle analysis and Lysis buffer for cell lysis (please refer to appropriate Application Notes provided by ChemoMetec concerning lysing of cells). Basics of the NucleoCounter system is explained on the next few pages.

The NucleoCounter system identifies and counts individual cell containing stained DNA. The sample pre-treatment is intended to allow the effective staining of cellular DNA but it will also aid the dissolving of cell aggregates. Depending on cell species and sample properties some additional effort might be needed to dissolve cell aggregates (please refer to appropriate Application Notes provided by ChemoMetec).

2.1 The NucleoCounter YC-100 instrument

The NucleoCounter is shown in the figure below.



Figure 2. NucleoCounter instrument

Refer to chapter 5 with respect to the operation of the instrument.

2.1.1 Fluorescence microscope

The compact fluorescence microscope integrated in the NucleoCounter comprises LED's (light emitting diodes) as excitation light source, excitation and emission filters, optics (lenses) and a CCD (charged coupled device) camera. Furthermore, the NucleoCounter contains advanced software for image processing. The fluorescence microscope, with a cassette inserted, is shown in Figure 3.

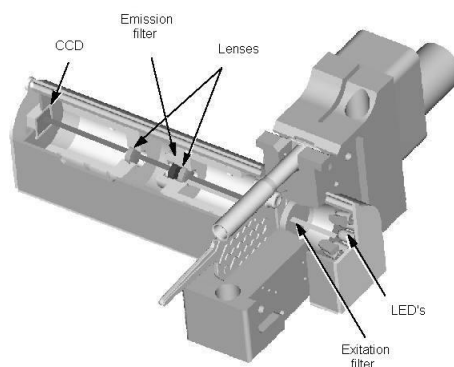

Figure 3. *The NucleoCounter's compact fluorescence microscope*

Before the NucleoCounter fluorescence microscope is activated a NucleoCassette is loaded with sample and inserted into the insertion slit of the instrument. The lid is closed in order to exclude external light from interfering with the analysis. The measurement is activated, by pressing the "Run" button.

When "Run" is activated, the actuator moves the piston rod down through the cylinder of the cassette. Hereby, the stained lyzate mixture is transported through the flow system of the cassette. The form and dimensions of the flow channels facilitate effective mixing of lyzate mixture and stain. Sensors monitor the liquid flow, and when the stained lyzate mixture has reached the measurement chamber of the cassette, the actuator stops the piston movement.

The measurement chamber is illuminated by green excitation light from light source. The green light is passed through an excitation filter before it reaches the measurement chamber. The excitation filter allows only green light of the appropriate wavelengths for the excitation of PI to pass.

The green light will excite the PI bound to DNA and in return PI emits red fluorescence light. Some of the green light will pass through the measurement chamber together with the red fluorescence light. This green light is removed by an emission filter, which only allows the red light to pass through. Using an optical lens system the red light is finally focused on the CCD chip of the camera.

A fluorescent image of the content of the measurement chamber is thus . Example of such an image is shown in Figure 4. Each spot in the image represents a cell containing DNA stained with PI.



Figure 4. *Fluorescent image (from NucleoView PC software) of cell DNA contained in the measurement chamber of a NucleoCassette*

2.1.2 Built-in image analysis

The NucleoCounter is equipped with advanced software for image analysis. This integral software analyzes the recorded image and counts the number of nuclei in the image. As the volume of the cassette measurement chamber and the dilution of the lyzate is known, the cell density in the initial sample can be calculated. The concentration of cells in the initial sample is presented in the NucleoCounter display. If the optional software (NucleoView) is used, the results and the recorded fluorescent image can be viewed.

The entire process takes approximately 30 seconds, from pressing “Run” to the presentation of the result in the display of the NucleoCounter.

Performing a cell count with the NucleoCounter is objective and the results are independent of the operator.

2.2 The NucleoCassette

The NucleoCassette is a custom made disposable plastic device designed for optimal sample handling and safe disposal. The cassette is shown in figure 5. The main features of the NucleoCassette are the piston, the flow system containing the fluorescent dye, propidium iodide, and the measurement chamber.

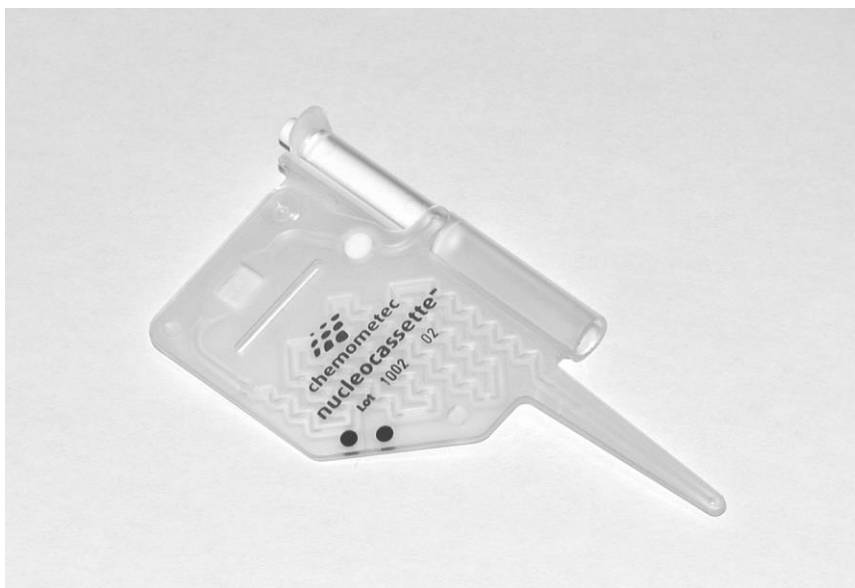

Figure 5 The NucleoCassette. The fluorescent dye, propidium iodide, is immobilized in the first part of the flow system.

2.2.1 Loading the cassette

The NucleoCassette is loaded by gently pressing the white piston, which creates a partial vacuum in the flow system. The tip of the NucleoCassette must be immersed into a lyzate mixture when pressing the piston, resulting in lyzate being loaded into the flow system. Approximately 50 μ l is loaded into the flow system.

2.2.2 Fluorescent dye

The fluorescent dye, propidium iodide, is immobilized in the first part of the flow system. As the stabilized lyzate is loaded into the NucleoCassette, the immobilized propidium iodide is dissolved immediately and mixed with the lyzate. Propidium iodide intercalates with DNA and forms a fluorescent stain, absorbing green light and emitting red light, which is utilized for detection of stained cells. Furthermore PI's ability to fluoresce is enhanced significantly upon binding to DNA thereby substantially enhancing selectivity.

During the analysis the stained mixture is transported through the flow system, where it is mixed with the propidium iodide, towards the chamber where the actual cell counting is performed. The precise volume analyzed, is determined individually for each cassette during analysis. This volume is approximately 1 μ l, and thus the volume analyzed is 10-20 times that of a conventional hemacytometer. After analysis the NucleoCassette is disposed of as biological waste.

2.2.3 Sample volume

During production each cassette is marked with a dot code, which specify the precise depth or thickness of the measurement chamber of the cassette. The dot code is read and decoded in the instrument during analysis and the volume

analysed is determined by multiplying the imaged area with the depth of the cassette. The imaged area is only dependent on the optics of the instrument. Therefore, the area is constant and specific for each instrument.

2.2.4 *Cassette handling*

The built-in image analysis method of the NucleoCounter offers considerable stability, when eliminating non-cellular objects from the image, including scratches and smears on the cassette windows, and thus producing valid results even under extreme conditions. On the other hand, the quality of the cell count is best assured by keeping the windows of the cassette as clean as possible.

Caution! In order to avoid contaminating the measurement window it is important not to touch the window when handling the cassettes. Be careful when attempting to wipe off the surface of the cassette, in an attempt to remove any foreign object, since the plastic material of the cassette can be scratched.

2.3 Lysis buffer

The lysis buffer for the lysing of yeast cells, Reagent Y100, is suitable for the sample preparation of majority of yeast cell suspensions. It is highly effective and generally achieves instantaneous lysing of yeast cells in suspension. Nevertheless certain species of yeast cells or samples might require different preparation. Thus if you encounter problems relating to insufficient lysing of yeast cells, please contact ChemoMetec A/S for assistance.

This page was intentionally left blank

3 Control Buttons, Keypad and Display

3.1 Interactive Controls

3.1.1 Control Buttons

There are four Control Buttons on the front of the instrument (see Figure 6):

Table 3. Control Buttons on NucleoCounter

On/Off	Use this button to turn the instrument on and off
Run	Use this button to start measuring
Esc	Use this button only as instructed in this manual
Del	Use this button only as instructed in this manual

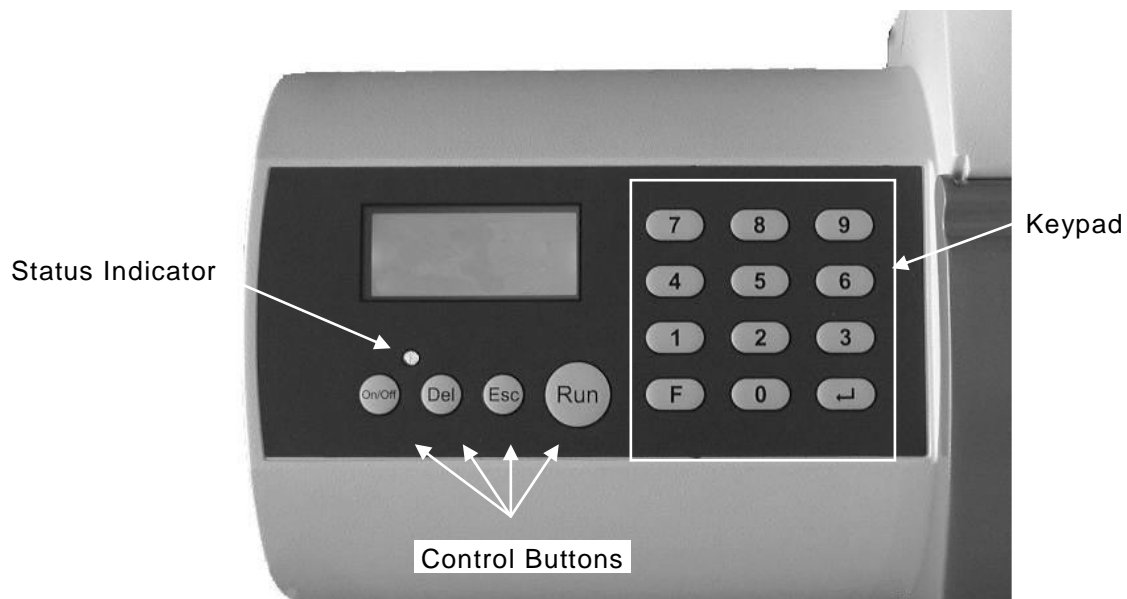

Figure 6. Control Buttons, Keypad and Status Indicator of NucleoCounter instrument

3.1.2 Keypad

The Keypad is comprised of 12 keys (see Figure 6): “0-9”, “F” (function key) and “↵” (Enter). The keypad is used for any entering of values used to alter the status of the instrument.

3.2 Interface Display

3.2.1 *Status indicator*

A small Status Indicator light above the “On/Off” button (see Figure 6) illuminates when the unit is turned on. It is green when the instrument is ready to measure and it turns red while the instrument is measuring or displaying an error message. The Status Indicator turns green after successful measurement when the results are displayed.

3.2.2 *Display screen*

The display screen communicates information to the user. It indicates, at various times: unit identification, software version, start-up status, operating functions, cell counts and shutdown status.

4 Installation and Start-up

4.1 Power on, power off

The NucleoCounter is powered by a 12VDC external power supply. To connect the power supply to the NucleoCounter, connect it to the DC socket (see Figure 7), and plug the mains power cord of the power supply into a wall outlet.



Figure 7. Connecting the 12VDC power cord plug to the NucleoCounter

The NucleoCounter can now be turned on and off by pressing the “On/Off” button on the front panel.

4.1.1 Starting up

Caution! During start-up the NucleoCounter performs a self-check. Never insert or remove any cassette during the start-up.

During start-up a brief noise is heard as the actuator motor is activated for test purposes. This is a part of a normal start-up procedure. While the NucleoCounter is starting up the display shows for a few seconds instrument details as follows:

```
NucleoCounter
YC-100
V4.XX 2005-MM-DD
S/N: 002-01
```

Figure 8. The start-up display

The start-up display shows the version number and date (year-month-date) of the internal software of the NucleoCounter YC-100 in line 3 (“v4.XX” in Figure 8). The

serial number of the instrument is shown in line 4 in the display (“002-01” in Figure 8).

After a successful start-up the display changes (Figure 9) and the status indicator on the keyboard panel turns green.

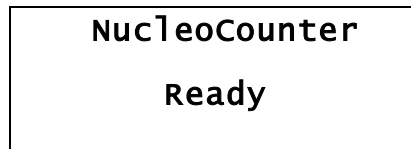

Figure 9. *The NucleoCounter is ready for cell counting*

If the instrument has performed as described above, it is ready for use. If the instrument displays an error message at start-up please refer to chapter 7.

4.1.2 Shutting down

Pressing the “On/Off” button shuts down the NucleoCounter and while the instrument shuts down, the display will momentarily look as shown in Figure 10.

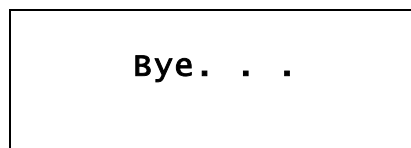

Figure 10. *The shutdown display.*

4.2 Installation of NucleoView

Regarding installation of the optional NucleoView PC-software, please refer to the NucleoView User’s Guide.

5 Operation of the NucleoCounter YC-100

5.1 Ready mode

After the NucleoCounter has started successfully the display should read:

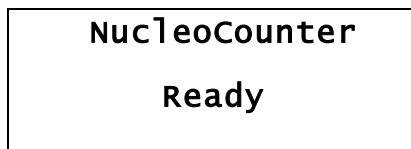

Figure 11. *The NucleoCounter is ready for cell counting.*

This display is also shown if the “Esc” button is activated in the result mode or any other situation, except during measuring or shutting down.

5.2 Inserting and removing the cassette

When a cassette has been properly loaded with lyzate mixture, the cassette is inserted into the NucleoCounter instrument.

5.2.1 Protection of the optical system

The sample compartment lid covers the cassette insertion area. This lid is designed to protect the area from dust and other potential contaminants, and to keep external light from interfering with the fluorescent image recording. The lid is fitted with magnetic hinges, so it can be easily removed for cleaning purposes.

Unless inserting/removing a cassette or cleaning the inserting area or the lid, the lid should be kept closed at all times as means of protecting the optical system of the NucleoCounter.

5.2.2 Inserting cassette

To insert the cassette:

1. Flip the lid up until it comes to a rest
2. Grip the cassette on either side of the piston cylinder, but taking care not to touch the measurement windows (see Figure 12).
3. Insert the cassette, bevelled edge down, into the insertion slit (see Figure 12).
4. Close the lid gently.

After analysis the lid is lifted and the cassette is removed from the insertion slit and disposed of according to national or regional laws or regulations regarding the nature of the mixture it contains.



Figure 12. Illustration of how to grip and insert the cassette into the insertion slit

5.3 Measuring - The Run button

When a cassette has been loaded and inserted into the instrument, the measurement is activated, by pressing the Run button.

5.3.1 Actuator movements

When Run is pressed, the actuator moves the piston rod down through the cylinder of the cassette. Hereby, the sample/dye mixture is transported to the cassette measurement chamber. The form and dimensions of the flow channels facilitate effective mixing of sample and stain. Sensors monitor sample flow. When the sample has been correctly loaded into the measurement chamber, the piston is stopped.

5.3.2 Result presentation

The analysis will occur after a few seconds and the fluorescent image is recorded. Once recorded, the image is analysed by the instrument's internal software. Upon completion of the analysis, the result is shown on the display. The entire process takes approximately 30 seconds.

5.3.3 External computer

If an external computer with the NucleoView software installed on it is connected, the results and the recorded fluorescent image can be viewed using the NucleoView software.

After the measurement is completed the cassette can be safely removed (see section 5.2). Sometimes, however, the complete process described above may be interrupted. Please familiarize yourself with possible error handling of the NucleoCounter presented in chapter 8.

5.4 Result display

Following a successful analysis, the cell density will be displayed on the display screen. Figure 13 shows an example of results as given on the display of the NucleoCounter instrument.

cells/ml:
1.234 x 10E6

Figure 13. Cell density of the cell lyzate, presented in Result mode 3.

5.4.1 Result mode

The NucleoCounter allows the results to be presented using one of three different representations of the results. In the default display mode (mode 3) the result is displayed with number of digits corresponding to full representation of the number of cells per μl (with 2, 3 or 4 digits). An overview of the representations, mode 2-4, is shown below. Mode 0 and 1 are not available.

Mode	Description
2	The result is presented with two digits - ex. 1.2×10^6 .
3	The result is presented with two, three or four digits - ex. 1.2×10^4 , 1.23×10^5 , 1.234×10^6 , corresponding to a full representation of the number of cells per ml.
4	The result is rounded off to an "even" number according to a table, rounding-off to an "even" number generally being within a 1/2 standard deviation of repeatability (precision). NB! This presentation does not compromise the performance of the NucleoCounter since the rounding-off does not affect any significant digit!

To change the representation of the results follow the directions below (a letter or number enclosed with "<" and ">" corresponds to a button on the keyboard).

- Press <F> <2> <1> on the keyboard of the NucleoCounter.
- Press enter <↵>.
- Press the mode-number of the desired representation, e.g. <3>.

- Press <↵>.

5.4.2 Saving parameters

The representation of the results is changed with effect from the next analysis. When the NucleoCounter is turned off, after changing the status, the display will read "Save parameters?", "ENTER: Save" and "ESC : Cancel" (figure 14).

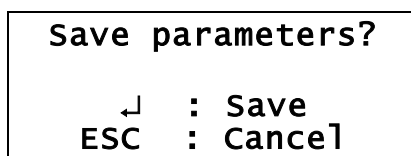

Figure 14 The shut-down display when any parameters have been changed.

By pressing the Enter key <↵> the status will be saved and will be in effect next time the NucleoCounter is switched on. Pressing Escape <Esc> will not save the status and the instrument will use the previous settings next time it is switched on.

5.4.3 Setting Date (F200) and Time (F201)

The functions, F200 ("F + 2 + 0 + 0 + ↵") and F201 ("F + 2 + 0 + 1 + ↵"), are used to set the time and the date, respectively. This feature is only used when a printer or a PC is connected to the printer port. Please refer to Technical Note 001 (Part No. 994-0013) with respect to setting and using the Time and Date features.

5.4.4 Reset Counter (F30)

The function, F30 ("F + 3 + 0 + ↵"), is used to reset the Counter. The Counter counts the number of analysis performed by the instrument. This feature is only used when a printer is connected to the instrument. Please refer to Technical Note 001 (Part No. 994-0013) with respect using this feature.

5.4.5 LCD contrast (F220)

When typing "F + 2 + 2 + 0 + ↵" it is possible to adjust the contrast of the LCD display. Use the "1" or "2" keys in order to increase or decrease the contrast of the LCD-display. The default value is 4. Values in the range from 0-9 can be chosen. The display will be updated with the current value, which is shown in the upper right hand corner of the display.

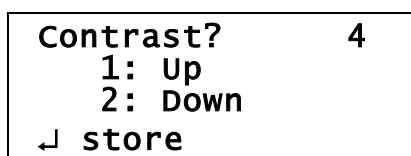

Figure 15. A new LCD-contrast value can now be chosen

```

Contrast?      6
  1: Up
  2: Down
↵ store

```

Figure 16. LCD-contrast value 6 is going to be chosen

Press “↵” to store the chosen value (or “**Esc**” to return to the previous value).

If the value has been changed the new contrast will be remembered during the session. When shutting down the NucleoCounter asks if the new value shall be saved as the new default value. Press “↵” to save or “**Esc**” if the present default value should not be overwritten.

5.4.6 Instrument Info (F100)

When typing “**F + 1 + 0 + 0 + ↵**” the Instrument Info will appear in the display as in the Display Text Type shown below.

```

ChemoMetec A/S
NC YC-100
V4.xx 2005-MM-DD
S/N: 002-01

```

Figure 17. Instrument Info

The display shows the name of the instrument in line 1 of the display and the instrument type in line 2 of the display. The version number and date (year-month-date) of the integral software of the instrument is shown in line 3. The serial number of the instrument is shown in line 4 of the display. The display text is almost identical to the start-up display text (Figure 8).

5.5 Instrument Sensitivity (F11)

The NucleoCounter YC-100 detects signals from propidium iodide which intercalates with double stranded DNA within the cell. Due to a variety of factors, such as strain, environment, growth phase and haploid/diploid forms the detected signal from yeast cells can vary. To allow the user to compensate for this it is possible to change the select different integration time for the CCD camera used to collect the fluorescent image. This is done by the user function F11, which is activated by typing “**F11 + ↵**”. Then the following dialogue will appear:

```

Setup? haploid
1:Up
2:Down
↵ store

```

Figure 18 Zero Count Check, step 1

To select the appropriate settings use the keys "1" and "2" to scroll in the list of options. The options are: Haploid, Diploid and Small. The labels refer to "typical" settings for the measurement of *Saccharomyces cerevesae*. The label of the settings are only to be considered as guidelines since other factors might influence the intensity of the observed signals.

The appropriate settings for any type and conditions of yeast cells are best found using the NucleoView software. The software illustrates Object Intensity Histogram for the measured sample. In order to determine the settings prepare a sample containing approximately 1,000 lysed cells per μl (1×10^6 cells/ml) and measure it on the NucleoCounter instrument using different sensitivity settings.

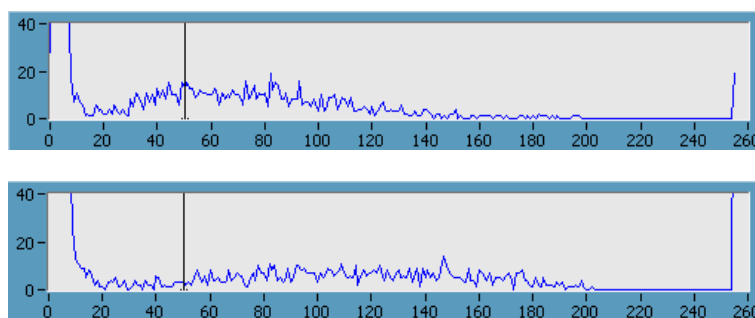

Figure 19 Object Intensity Histogram using different sensitivity settings.

The figure above illustrate firstly (on top) a sample measured with too low sensitivity, seen by the relatively high number of cells found below the sensitivity discriminator at 50. The Object Intensity Histogram at the bottom illustrates the same sample measured with higher sensitivity, where the main intensity population is observed above the sensitivity discriminator.

The effect of inappropriate sensitivity setting is an over or underestimation of the cell concentration. It is difficult to give accurate estimates of the magnitude of the error, but it can be on the order of between 5 and 30%, so due attention should be given to choosing the appropriate sensitivity setting.

5.6 Zero Count Check (F50)

The instrument can perform a so called Zero Count Check (only firmware v 3.04 or higher). This check is carried out **without** cassette in the insertion slit of the

instrument and with the lid closed. The check determines the number of CCD-pixels that show elevated signal levels. If the number of pixels is above a predefined limit then the cassette insertion slit can be contaminated with an interfering particle, like a dust particle. An error message is shown in the display and a cleaning of the insertion slit is recommended (refer to chapter 7 Maintenance of NucleoCounter).

If a PC with NucleoView is connected to the instrument a contaminant is usually observed as an object, which is stationary in all images.

To initiate a Zero Count Check type in "F50 + ↵". Then the following text will appear in the display:

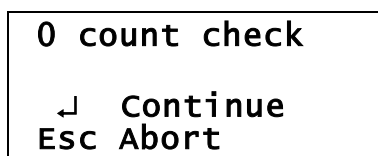

0 count check
↵ Continue
Esc Abort

Figure 20 Zero Count Check, step 1

Press "↵" to continue. Now the instrument prompts you to remove any cassette from the insertion slit:

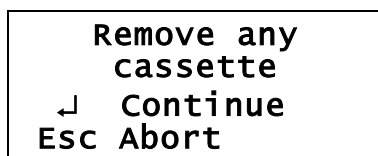

Remove any
cassette
↵ Continue
Esc Abort

Figure 21 Zero Count Check, step 2

Press "↵" to continue. Now the instrument prompts you to close the lid in order to avoid false light from entering the insertion slit during the Zero Count Check:

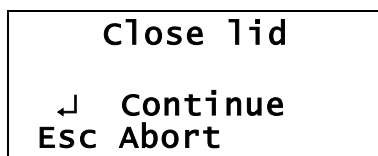

Close lid
↵ Continue
Esc Abort

Figure 22 Zero Count Check, step 3

Press "↵" to continue. Then a "Wait" message appears in the display:

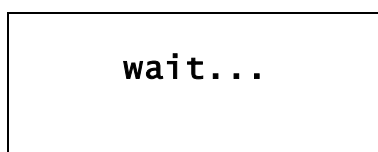

wait...

Figure 23 Zero Count Check, step 3A

After a few seconds the instrument has performed the Zero Count Check. If no contamination of the insertion slit can be detected an "OK" message appears in the display (see the figure below). Press any key to return to "Ready mode".

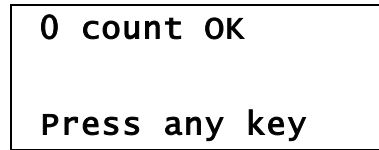

0 count OK
Press any key

Figure 24 The result of the Zero Count Check is OK

If a contamination of the insertion slit is detected an error message is shown:

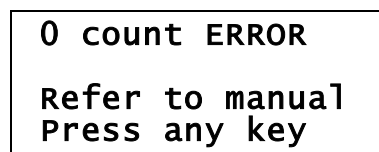

0 count ERROR
Refer to manual
Press any key

Figure 25 The Zero Count Check did not pass the test

If the Zero Count Check returns an error, it is recommended to clean the insertion slit, e.g. with compressed, dry air (refer to chapter 7 Maintenance of NucleoCounter and Technical Note No. 004 "How to clean the NucleoCounter"). Perform the Zero Count Check again. If the error appears even after several attempts to clean the insertion slit with compressed air and if necessary the NucleoCounter® Clean Kit, contact ChemoMetec

6 Total and viability count

The NucleoCounter detects fluorescent signals from propidium iodide (PI) when it is bound to double-stranded DNA (dsDNA). The fluorescent intensity of PI is increased substantially upon binding to dsDNA. As a result the NucleoCounter detection is highly specific and sensitive. The staining of the dsDNA requires that PI can penetrate the cell membrane. As with several dyes used for the staining of cells the cell membrane of living cells is impermeable to PI while dead or damaged cells are readily stained with PI.

6.1 Non-viable Cell Concentration

In analogy with several other dye exclusion methods, such as methylene blue staining, the NucleoCounter method uses dye permeability for the determination of non-viable cells. Thus by measuring suspended cells under conditions where viability of the cells is retained, only cells directly stained with PI are assumed to be non-viable. Therefore when determining the concentration of non-viable cells the cells are diluted by an isotonic solution, or any other solution that preserves viability of the cells, and then the NucleoCassette is loaded with this solution. Since PI does not stain viable cells only non-viable cells are detected, resulting in the determination of non-viable cell concentration.

6.2 Total Cell Concentration

In order to determine the total cell concentration it is necessary to subject the cells to a treatment that renders the cell membrane permeable to PI. This is most easily done by diluting the cell suspension with Reagent Y100, which is an effective cell lysing agent. Other methods of lysing the cells can also be used, which do not affect the staining and/or fluorescence efficiency of PI. For recommended method for lysing cells please refer to appropriate application note.

6.3 Determination of Viability

When both the concentration of non-viable cells and the total concentration of cells are known, it is possible to calculate the viability (%viability) of the cells or the concentration of viable cells. For the calculation the multiplication factors must be taken into account, which is the total dilution of the original sample, as in the equation shown below.

$$\%viability = \frac{G \cdot M_t - C_{nv} \cdot M_{nv}}{G \cdot M_t} \cdot 100\%$$

- %viability: The percentage of viable cells in the original cell suspension
- C_t : The total concentration of cells in the NucleoCassette (the displayed result of the total cell count)
- C_{nv} : The concentration of non-viable cells in the NucleoCassette (the result displayed when counting the non-viable cells)
- M_t : The multiplication factor used for the total cell count, e.g. the dilution of the sample with diluent and lysing reagent
- M_{nv} : The multiplication factor used for the counting of non-viable cells, e.g. the combined dilution of the sample by diluent

7 Maintenance of NucleoCounter YC-100

A regular cleaning of the NucleoCounter is recommended in order to protect its surface and assure the quality of the collected images.

7.1 Cleaning

Depending on the environment in which the NucleoCounter is operated it is suggested that regular cleaning of the cabinet is carried out. When cleaning the cabinet it is recommended to use a soft moist cloth and gently wipe the surface. Any contamination, which does not come off immediately, should be rubbed gently with a cloth wetted with mild detergent. Never use organic solvents or aggressive detergents to clean the exterior of the NucleoCounter as this might damage the surface.

7.1.1 *Cassette insertion area*

The cassette insertion area and the optical parts inside the NucleoCounter should be properly protected against dust and other contaminants. Therefore, great care must be taken to ensure that the lid covering the cassette insertion area is closed when cassettes are not being loaded into or removed from the NucleoCounter. If the insertion area becomes contaminated it should immediately be cleaned with a clean, dry and dust free cloth.

When cleaning the cassette insertion area, great care must be taken against introducing any liquid or dust into the insertion slit of the NucleoCounter. Any liquid that enters the interior of the NucleoCounter can damage the optical parts and thus compromise the quality of the cell counts.

7.1.2 *Optical elements*

An object on the surface of an optical component can influence the collected image. A contaminant will normally be visible as a faint object in the image. Since it is also possible that such contamination is on the surface of the cassette, only objects, which are stationary in all images, are possible contaminations of the optical system. An example of a relatively large contamination is given in Figure 26.

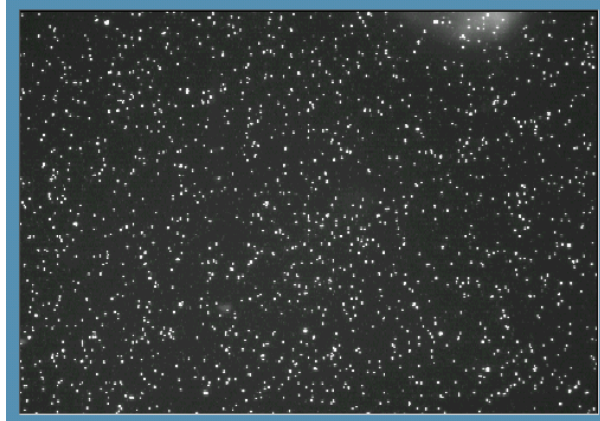

Figure 26. An image showing a contamination of the optical system, visible as a white cloudy phenomena in the upper right hand corner. If the contamination is stationary it should be removed using compressed air.

7.1.3 Removal of dust particles

The presence of a contaminant (e.g. dust particles) will normally not influence the counting of cells. The NucleoCounter will distinguish between cells and contaminants, since cell is generally significantly smaller than contaminants.

Dust and other contaminants deep inside the insertion slit should be removed using dry, compressed air (see Figure 27).



Figure 27. Removal of dust from the insertion slit using compressed air. Never use the container in a horizontal position and preferable do not use it at an angle greater than shown in the figure.

7.1.4 Spill of liquid

If liquid has been spilled on the instrument it can contaminate elements of the optical system. This contamination can show up in the image in several ways and have many causes but a common feature is that it cannot be removed by the use of compressed air.

Even though such phenomena are clearly visible on the image it only rarely affects the results of the NucleoCounter. Since it is possible to damage the optical system while attempting to clean the system it is recommended that ChemoMetec A/S should be consulted before the user attempts such cleaning.

This page was intentionally left blank

8 Troubleshooting - Error messages

Under certain conditions the NucleoCounter will display error messages during operation. Corrective actions are suggested below but if they do not correct the errors, contact ChemoMetec A/S or the local distributor.

8.1 No valid cassette

When trying to analyze a cassette, which is not valid, the NucleoCounter displays the error message shown in Figure 28.

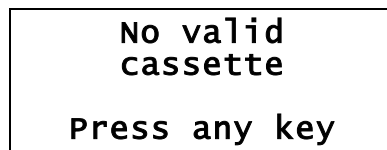

**No valid
cassette**
Press any key

Figure 28. *The error message displayed when the NucleoCounter does not recognize the cassette as valid*

This error message is displayed in the following situations:

- The cassette has been analyzed previously
- The cassette is not inserted properly into the NucleoCounter
- There is no cassette inserted into the NucleoCounter

8.2 Analysis aborted

The NucleoCounter displays the error message shown in Figure 29 when the analysis has been aborted because the stained mixture inside the cassette has not reached the chamber within a given time.

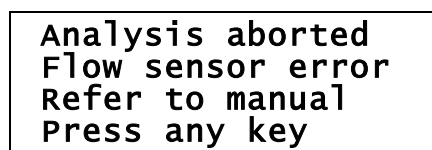

Analysis aborted
Flow sensor error
Refer to manual
Press any key

Figure 29. *Error message displayed by the NucleoCounter when the analysis has been aborted*

A common cause of this is that an insufficient volume of lyzate mixture has been loaded into the cassette. Load a new cassette and repeat the analysis.

The error will also occur if the cassette has not been inserted properly into the NucleoCounter. Then the instrument cannot press the piston down and the error occurs. Take out the cassette, insert it properly and run the analysis.

8.3 Actuator error messages

The actuator moves the piston down into the barrel of the cassette. Two different actuator error messages can be displayed. These error messages are shown in Figure 30. The same action is to be taken if either of the error messages appears.

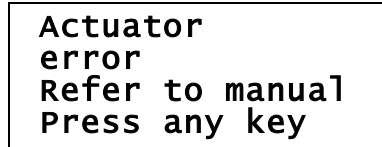

Actuator
error
Refer to manual
Press any key

Figure 30. *The NucleoCounter can display this message regarding the actuator*

First, examine if the cassette has been inserted properly. If not, insert the cassette once more and attempt the analysis again. If the cassette was inserted properly turn the NucleoCounter off and on a few times. If the actuator moves during start-up it is likely that the error has been corrected.

8.4 Sample could not be analyzed

When the NucleoCounter cannot determine the concentration of cells during analysis the error message in Figure 31 is displayed.

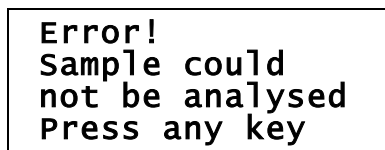

Error!
Sample could
not be analysed
Press any key

Figure 31. *This error message is displayed when the concentration of cells in the cassette cannot be determined*

The error appears if the concentration of stained nuclei inside the cassette chamber is far too high, e.g. when the sample is insufficiently diluted. The message can also appear if the lid is not closed, which may cause ambient light to interfere with the analysis.

8.5 Sensor error

The black dots, which are printed on the cassettes are read by sensors inside the NucleoCounter each time an analysis is run. The dots code for the volume of lyzate mixture in the cassette chamber. If one or more of the sensors has a faulty operation an error message will be displayed, see Figure 32.

<p>Sensor error</p> <p>Refer to manual</p> <p>Press any key</p>

Figure 32. This error message is displayed if one of the sensors, which read the black dots on the cassettes, causes error.

If the error message is displayed analyses can still be made but the accuracy of the results cannot be guaranteed since the volume of the measurement chamber may not be read correctly.

8.6 Power-on failure

If the NucleoCounter cannot be turned on, please verify that the power supply is connected to the NucleoCounter and a working power plug.

If the NucleoCounter still does not turn on, inspect and/or replace the fuses as described below.

The fuse holder is located just above the NucleoCounter's power plug, see Figure 33.

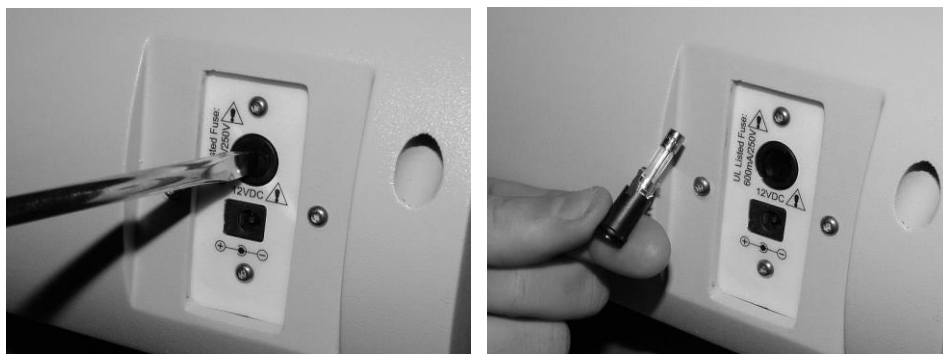

Figure 33. Location and removal of the fuse holder

Disconnect the power supply from the NucleoCounter. Then remove the fuse holder by use of a screwdriver (turn CCW) as indicated in Figure 33. Inspect the fuse. If it needs replacement use an UL Listed fuse: 600mA/250Vac (UL 248).

If the NucleoCounter does not turn on after replacement of the fuse, or if the fuse was not broken, please contact ChemoMetec A/S or the local distributor for further instructions.

This page was intentionally left blank

9 Technical specifications

9.1 Technical specifications for NucleoCounter YC-100

Specificity	Cells stained with the DNA specific fluorescent dye, PI.	
Sample types	Suspension of dispersed yeast cells.	
Sample consumption	A minimum of 100µl is recommended for the NucleoCassette loading. Approximately 50 µl of sample is loaded into the cassette.	
Analysis volume	Approximately 1 µl of the sample is being analyzed in the NucleoCounter YC-100.	
Measurement range	Measurement range:	5x10 ³ to 6x10 ⁶ cells/ml
	Optimal Measurement range:	5x10 ⁴ to 6x10 ⁶ cells/ml
Presentation of Result	The NucleoCounter YC-100 presents the estimated cell density in the sample in the cassette. In order to obtain the cell concentration in the original cell suspension the result must be multiplied with the appropriate multiplication factor to compensate for any dilution.	
Operation	Menu-controlled by means of keyboard and LCD display.	
Analysis time	When pressing “Run” on the NucleoCounter YC-100 the result will be displayed within 30 seconds.	
Physical data	Weight	3 kg
	Height	26 cm
	Width	38 cm
	Depth	22 cm
Power	⚠ See Section 10.2 Power Supply	
	Input	12VDC (11-13VDC)
	Fuse	UL Listed fuse: 600mA/250Vac (UL 248)
Power consumption NucleoCounter	Peak	25 W
	Ready mode	2.5 W
	Standby	2 mW
Operation conditions	Maximum relative humidity 80 percent for temperatures up to 31°C decreasing linearly to 65 percent relative humidity at maximum 35°C; minimum temperature 15°C.	
USB	USB, version 1.1. Note: Does not support USB Hubs.	
Printer	Thermal or Impact printer with RS-232 interface and cable supplied by ChemoMetec A/S.	

Other environmental operating conditions for the NucleoCounter

Indoor use only.

Altitude Up to 2000 m.

INSTALLATION CATEGORY II (Refer to UL 61010A-1)

OVERVOLTAGE CATEGORY II (Refer to UL 61010A-1)

POLLUTION DEGREE II (Refer to UL 61010A-1)

9.2 The NucleoCassette™

Reagent Each NucleoCassette contains approximately 2,8 µg propidium iodide.

Storage Store the NucleoCassettes in a sealed foil bag at max. 30°C.

Stability See documentation delivered with the NucleoCassettes.

9.3 EMC/EMI standards

The NucleoCounter YC-100 complies with EMC/EMI standards as follows.

EN61326: 1997+A1: 1998 (Class B) +A2: 2000, Electrical equipment for measurement, control and laboratory use – EMC requirements (emission and immunity). Annex B and C from A1: 1998 is used.

This device complies with Part 15 of the FCC Rules. Operation is subject to the following two conditions: (1) this device may not cause harmful interference, and (2) this device must accept any interference received, including interference that may cause undesired operation.

10 Equipment and Accessories

10.1 Equipment and Accessories List

The equipment and accessories for the NucleoCounter are listed in the table below.

⚠ Ensure that items marked with this symbol are the only equipment and accessories used together with the NucleoCounter.

Table 4. *Equipment and Accessories for NucleoCounter system*

Item	Part no.	Description
NucleoCounter YC-100	900-0300	Instrument
NucleoCassette, 100 pcs.	941-0002 ⁴	A disposable device used for performing the cell-count
Reagent Y100, 500 ml	910-0300 ⁵	A reagent used for lysis of cells prior to measurement
CD with NucleoView v. 2.x	950-0003	PC software used for handling of the obtained cell counts
User's Guide YC-100	991-0300	User's guide for the NucleoCounter YC-100 (English version)
User's Guide NucleoView v. 2.x	991-0006	User's guide for the NucleoView software
USB Cable, 2 Meters	931-0001	A USB cable used for transmission of image data from the NucleoCounter to an external PC
Power supply	See section below	A device for generating the DC-voltage for the NucleoCounter from the mains supply
Fuse 5x20mm 600mA 10 pcs.	939-0001	A device for protecting the NucleoCounter against over current
Mains Power cord	See section below.	A cord for mains supply of the external power supply
Dry, compressed air	See section below	Used for removal of dust from the optical system of the NucleoCounter
Dispenser 0.05-0.5 mL	911-0001	Dispenser for Reagent A100 or Reagent B
Bottle Stand	929-0001	Holder for Reagent A100 and Reagent B bottles
Impact Printer DP24-S1N	939-0003	Optional impact printer,

⁴ In a box with 10 bags each containing 10 cassettes.

⁵ In a container with 0.5 Litres (sufficient for 500-1,000 analysis)

Item	Part no.	Description
		using ink ribbon, for the NucleoCounter
Thermo Printer PCNEOS-S2BN	939-0006	Optional thermo printer, using thermo paper, for the NucleoCounter
Paper Impact Printer, 5 RL	939-0004	5 roles of paper for impact type printer
Ribbon Impact Print, 1pcs	939-0005	One printer ribbon for impact type printer
Paper Thermo Printer, 5 RL	939-0007	5 roles of thermo paper
Applic. Note 300-GB	994-0300	Total cell count of yeast ⁶ using the NucleoCounter YC-100
Applic. Note 302-GB	994-0302	Total cell count and viability of yeast ⁶ in beer samples using the NucleoCounter YC-100

10.2 Power supply

⚠ The NucleoCounter shall only be used with one of the following external power supplies:

- Power supply Class I, Proton Electronic Industrial Co. Ltd., model SPN-260-12, input rated 100-240 Vac, 50-60Hz, 1.6 A. Output rated 12 Vdc, 4.3 A.
- Power supply Class I, Powerbox Europe AB, model EBH 03 131, input rated 100-240 Vac, 47-63 Hz, 0.8A. Output rated 11-13 Vdc, 2.7 A.
- Power supply Class II, Celetron USA Inc., model ZVC40LT12E, input rated 100-240 Vac, 50-60Hz, 1.2 A. Output rated 12 Vdc, 3.3 A.

⚠ The detachable power supply cord set and appliance inlet of the external power supply are considered as the disconnecting device.

Contact ChemoMetec A/S for information on order of a specific power supply listed above.

10.3 Mains Power cord

Detachable power supply cord set for the Class I specified power supplies:

For US 125 Vac

⁶ *Saccharomyces cerevisiae*

UL listed, type SVT, rated min. 60C, 18 AWG, 3 conductors. Provided with molded-on grounding-type (NEMA 5-15P) attachment plug, rated min. 125 Vac, min. 2.5A. Opposite end terminates in molded on, IEC320 style connector, rated min. 125 Vac, min. 2.5 A.

For Europe 250Vac

Cord type min. H05RR-F or min. H03VV-F or min. H03VVH2-F, rated min. 60C, 3x0.75 mm². Provided with molded-on grounding-type attachment Plug, rated min. 250 Vac, min. 2.5 A. Opposite end terminates in molded on, IEC320 style connector, rated min. 250 Vac, min. 2.5 A.

Detachable power supply cord set for the specified Class II power supply:

For US 125 Vac

UL listed, type SPT-2 or SVT, rated min. 60C, 18 AWG, 2 conductors. Provided with molded-on un-grounding-type (NEMA 1-15P) attachment Plug, rated min. 125 Vac, min. 2.5 A. Opposite end terminates in molded on, IEC320 style connector, rated min. 125 Vac, min. 2.5 A.

For Europe 250Vac

Cord type min. H05RR-F or min. H03VV-F or min. H03VVH2-F, rated min. 60C, 2x0.75mm². Provided with molded-on un-grounding-type attachment Plug, rated min. 250 Vac, min. 2.5 A. Opposite end terminates in molded on, IEC320 style connector, rated min. 250 Vac, min. 2.5 A.

⚠ The Mains supply cord and plug of the external power supply shall comply with any national regulations.

⚠ The user shall be made aware of that, if the NucleoCounter and the external power supply is used in a manner not specified by the manufacturer, the protection provided by the NucleoCounter and the external power supply may be impaired.

Contact ChemoMetec A/S for information on order of a specific Power supply cord listed above.

10.4 Dry compressed air

Dry, compressed air (KENAIR Air Duster - CFC Free) is used for removal of dust from the optical system of the NucleoCounter (refer to chapter 7).

The item can be obtained from Kenro Ltd, Greenbridge Road, Swindon SN3 3LH, UK. Tel: +44 (0) 1793 615836, E-mail: sales@kenro.co.uk. Alternatively the item, or a similar item, might be available through local dealers.

10.5 External Printer (optional)

⚠ An external impact or thermo printer may optionally be connected to the NucleoCounter for the printing of test results.

For connection of a printer (Impact type CM no. 939-0003; thermo type CM type no. 939-0006) please refer to Technical Note 001 (Impact type CM no. 994-0013; thermo type CM no. 994-0014).

The NucleoCounter is equipped with a printer output port. It is located just below the USB connector on the rear side as apparent from Figure 34 and Figure 35



Figure 34 Location of the Printer output on the NucleoCounter



Figure 35 Connecting the Printer cable to the NucleoCounter (lower connector).

Table 5 Description of the NucleoCounter Printer Output connector

Pin no	Name	Maximum Voltage level ⁷
1 ⁸		
2	Rx	±10 VDC
3	Tx	±10 VDC
Metal Enclosure	DGND	0 VDC

⁷ In normal operation. Refers to DGND Metal Enclosure. Taken from the datasheet for MAX202ECSE.

⁸ There is no signal connected to pin 1.

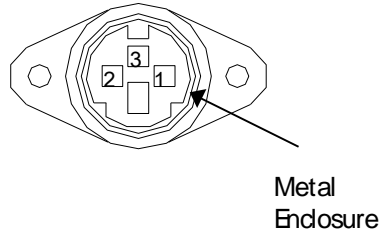

Figure 36 Printer Output connector seen from the cable entry side.



This page was intentionally left blank

11 Appendix 1: WEEE directive information in more EU languages

United Kingdom

Correct Disposal of This Product (Waste Electrical & Electronic Equipment) - Europe only



This marking shown on the product or its literature, indicates that it should not be disposed together with other household wastes at the end of its working life. To prevent possible harm to the environment or human health from uncontrolled waste disposal, please separate this from other types of wastes and recycle it responsibly to promote the sustainable reuse of material resources.

Business users should contact their supplier and check the terms and conditions of the purchase contract. This product should not be mixed with other commercial wastes for disposal.

Sweden

Korrekt avfallshantering av produkten (elektriska och elektroniska produkter) - Endast för Europa



Denna markering på produkten och i manualen anger att den inte bör sorteras tillsammans med annat hushållsavfall när dess livstid är över. Till förebyggande av skada på miljö och hälsa bör produkten hanteras separat för ändamålsenlig återvinning av dess beståndsdelar.

Företagsanvändare bör kontakta leverantören samt verifiera angivna villkor i köpekontraktet. Produkten bör inte hanteras tillsammans med annat kommersiellt avfall.

Slovenia

Ustrezno odstranjevanje tega izdelka (odpadna električna in elektronska oprema) - Samo Evropa



Oznaka na izdelku ali spremljevalni dokumentaciji pomeni, da ga na koncu uporabne dobe ne smemo odstranjevati skupaj z drugimi gospodinjstskimi odpadki. Da bi preprečili morebitno tveganje za okolje ali zdravje človeka zaradi nenadzorovanega odstranjevanja odpadkov, izdelek ločite od drugih vrst odpadkov in ga odgovorno reciklirajte ter tako spodbudite trajnostno ponovno uporabo materialnih virov.

Podjetja naj pokličejo dobavitelja in preverijo pogoje nabavne pogodbe. Tega izdelka pri odstranjevanju ne smete mešati z drugimi gospodarskimi odpadki.

Slovakia

Správna likvidácia tohoto výrobku (Elektrotechnický a elektronický odpad) - Platí len pre Európu



Toto označenie na výrobku alebo v sprievodnej brožúre hovorí, že po skončení jeho životnosti by nemal byť likvidovaný s ostatným odpadom. Prípadnému poškodeniu životného prostredia alebo ľudského zdravia môžete predísť tým, že budete takéto typy výrobkov oddeľovať od ostatného odpadu a vrátite ich na recykláciu.

Priemyselní používatelia by mali kontaktovať svojho dodávateľa a overiť si podmienky kúpnej zmluvy. Tento výrobok by nemal byť likvidovaný spolu s ostatným priemyselným odpadom.

Portugal

Eliminação Correcta Deste Produto (Resíduo de Equipamentos Eléctricos e Electrónicos) - Apenas na Europa



Esta marca, apresentada no produto ou na sua literatura indica que ele não deverá ser eliminado juntamente com os resíduos domésticos indiferenciados no final do seu período de vida útil. Para impedir danos ao ambiente e à saúde humana causados pela eliminação incontrolada de resíduos deverá separar este equipamento de outros tipos de resíduos e reciclá-lo de forma responsável, para promover uma reutilização sustentável dos recursos materiais.

Os utilizadores profissionais deverão contactar o seu fornecedor e consultar os termos e condições do contrato de compra. Este produto não deverá ser misturado com outros resíduos comerciais para eliminação.

Poland

Prawidłowe usuwanie produktu (zużyty sprzęt elektryczny i elektroniczny) - Tylko obszar Europy



Oznaczenie umieszczone na produkcie lub w odnoszących się do niego tekstach wskazuje, że produktu po upływie okresu użytkowania nie należy usuwać z innymi odpadami pochodzącymi z gospodarstw domowych. Aby uniknąć szkodliwego wpływu na środowisko naturalne i zdrowie ludzi wskutek niekontrolowanego usuwania odpadów, prosimy o oddzielenie produktu od innego typu odpadów oraz odpowiedzialny recykling w celu promowania ponownego użycia zasobów materialnych jako stałej praktyki.

Użytkownicy w firmach powinni skontaktować się ze swoim dostawcą i sprawdzić warunki umowy zakupu. Produktu nie należy usuwać razem z innymi odpadami komercyjnymi.

Norway**Korrekt avhending av dette produkt
(Avfall elektrisk og elektronisk utstyr) - Kun Europa**

Denne merkingen som vises på produktet eller dens dokumentasjon, indikerer at den ikke skal kastes sammen med annet husholdningsavfall ved slutten av sin levetid. For å hindre mulig skade på miljøet eller menneskelig helse fra ukontrollert avfallsavhending, vennligst atskill dette fra andre typer avfall og resirkuler det ansvarlig for å fremme bærekraftig gjenbruk av materielle ressurser.

Forretningsbrukere bør kontakte sin leverandør og undersøke vilkårene i kjøpekontrakten. Dette produktet skal ikke blandes med annet kommersielt avfall som skal kastes.

Netherlands**Correcte verwijdering van dit product
(elektrische & elektronische afvalapparatuur) - Alleen Europa**

Dit merkteken op het product of het bijbehorende informatiemateriaal duidt erop dat het niet met ander huishoudelijk afval verwijderd moet worden aan het einde van zijn gebruiksduur. Om mogelijke schade aan het milieu of de menselijke gezondheid door ongecontroleerde afvalverwijdering te voorkomen, moet u dit product van andere soorten afval scheiden en op een verantwoorde manier recyclen, zodat het duurzame hergebruik van materiaalbronnen wordt bevorderd.

Zakelijke gebruikers moeten contact opnemen met hun leverancier en de algemene voorwaarden van de koopovereenkomsten nalezen. Dit product moet niet worden gemengd met ander bedrijfsafval voor verwijdering.

Latvia**Izstrādājuma pareiza likvidēšana
(nolietotas elektriskās un elektroniskās ierīces) - Tikai Eiropā**

Uz izstrādājuma vai tam pievienotajās instrukcijās dotais marķējums norāda, ka to nedrīkst likvidēt kopā ar citiem sadzīves atkritumiem pēc tā ekspluatācijas laika. Lai novērstu vidi un cilvēku veselībai iespējamo kaitējumu, kas ir saistīts ar nekontrolējamu atkritumu likvidēšanu, tas jānošķir no citiem atkritumiem un jāpārstrādā, lai sekmētu materiālo resursu atbildīgu atkārtotu lietošanu.

Rūpnieciskajiem lietotājiem jāsažinās ar piegādātāju un jāpārbauda pirkuma līguma nosacījumi. Šo izstrādājumu nedrīkst sajaukt ar citiem likvidējamajiem rūpnieciskajiem atkritumiem.

Lithuania**Tinkamas produkto atliekų tvarkymas
(atitarnavusi elektros ir elektronikos įranga) - Tik Europai**

Šis ženklas, pateikiamas ant produkto ar jo dokumentacijoje, nurodo, kad pasibaigus produkto tarnavimo laikui, jo negalima išmesti kartu su kitomis buitinėmis atliekomis. Kad būtų išvengta galimos nekontroliuojamo atliekų išmetimo žalos aplinkai arba žmonių sveikatai, ir siekiant skatinti aplinką tausojantį antrinių žaliavų panaudojimą, pašom atskirti jį nuo kitų rūšių atliekų ir atiduoti perdirbti.

Verslo vartotojai turėtų kreiptis į savo tiekėją ir peržiūrėti pirkimo sutarties sąlygas. Šis produktas tvarkant atliekas negali būti sumaišytas su kitomis atliekomis.

Italy**Corretto smaltimento del prodotto
(rifiuti elettrici ed elettronici) - Solo Europa**

Il marchio riportato sul prodotto o sulla sua documentazione indica che il prodotto non deve essere smaltito con altri rifiuti domestici al termine del ciclo di vita. Per evitare eventuali danni all'ambiente o alla salute causati dall'inopportuno smaltimento dei rifiuti, si invita l'utente a separare questo prodotto da altri tipi di rifiuti e di riciclarlo in maniera responsabile per favorire il riutilizzo sostenibile delle risorse materiali.

Gli utenti aziendali sono invitati a contattare il proprio fornitore e verificare i termini e le condizioni del contratto di acquisto. Questo prodotto non deve essere smaltito unitamente ad altri rifiuti commerciali.

Hungary**A termék megfelel leadása
(Elektromos és elektronikus készülékek hulladékkezelése) - Kizárólag Európá**

A terméken vagy a hozzá tartozó dokumentáción szerepl jelzés arra utal, hogy hasznos élettartama végén a terméket nem szabad háztartási hulladékkal együtt kidobni. Annak érdekében, hogy megel zhet legyen a szabálytalan hulladékleadás által okozott környezet- és egészségkárosodás, különitse ezt el a többi hulladéktól, és felel sségteljesen gondoskodjon a hulladék leadásáról, a hulladékhanyagok fenntartható szint újrafelhasználása céljából.

Az üzleti felhasználók lépjenek kapcsolatba a forgalmazóval, és vizsgálják meg az adásvételi szerz és feltételeit. A terméket nem szabad leadni kereskedelmi forgalomból származó egyéb hulladékkal együtt.

France**Comment éliminer ce produit
(déchets d'équipements électriques et électroniques) - Europe uniquement**

Ce symbole sur le produit ou sa documentation indique qu'il ne doit pas être éliminé en fin de vie avec les autres déchets ménagers. L'élimination incontrôlée des déchets pouvant porter préjudice à l'environnement ou à la santé humaine, veuillez le séparer des autres types de déchets et le recycler de façon responsable. Vous favoriserez ainsi la réutilisation durable des ressources matérielles.

Les entreprises sont invitées à contacter leurs fournisseurs et à consulter les conditions de leur contrat de vente. Ce produit ne doit pas être éliminé avec les autres déchets commerciaux.

Finland

**Tämän tuotteen turvallinen hävittäminen
(elektronikka ja sähkölaitteet) - Vain Eurooppa**



Oheinen merkintä tuotteessa tai tuotteen oheismateriaalissa merkitsee, että tätä tuotetta ei tule hävittää kotitalousjätteen mukana sen elinkaaren päätyttyä. Hallitsemattomasta jätteenkäsittelystä ympäristölle ja kanssaihminen terveydelle aiheutuvien vahinkojen välttämiseksi tuote tulee käsitellä muista jätteistä erillään. Jäte on hyvä kierrättää raaka-aineiksi kestäväan ympäristökehityksen takia.

Yrityskäyttäjien tulisi ottaa yhteyttä tavarantoimittajaan ja selvittää hankintasopimuksen ehdot. Tätä tuotetta ei tule hävittää muun kaupallisen jätteen seassa.

Estonia

**Õige viis toote kasutusest kõrvaldamiseks
(elektriliste ja elektrooniliste seadmete jäätmed) - Ainult Euroopa**



Selline tähistus tootel või selle dokumentidel näitab, et toodet ei tohi kasutusaja lõppemisel kõrvaldada koos muude olmejäätmetega. Selleks, et vältida jäätmete kontrollimatu kõrvaldamisega seotud võimaliku kahju tekitamist keskkonnale või inimeste tervisele ning edendada materiaalse vahendite säästvat taaskasutust, eraldage toode muudest jäätmetest ja suunake taasinglusse.

Firmad peaksid võtma ühendust tarnijaga ning kontrollima ostulepingu tingimusi ja sätteid. Toodet ei tohi panna muude hävitamiseks mõeldud kaubandusjäätmete hulka.

Spain

**Eliminación correcta de este producto
(material eléctrico y electrónico de descarte) - Europa solamente**



La presencia de esta marca en el producto o en el material informativo que lo acompaña, indica que al finalizar su vida útil no deberá eliminarse junto con otros residuos domésticos. Para evitar los posibles daños al medio ambiente o a la salud humana que representa la eliminación incontrolada de residuos, separe este producto de otros tipos de residuos y reciclelo correctamente para promover la reutilización sostenible de recursos materiales.

Los usuarios comerciales pueden contactar con su proveedor y consultar las condiciones del contrato de compra. Este producto no debe eliminarse mezclado con otros residuos comerciales.

Greece

**Σωστή Διάθεση αυτού του Προϊόντος
(Απορρίμματα Ηλεκτρικού & Ηλεκτρονικού Εξοπλισμού) - Μόνον για την Ευρώπη**



Τα σήματα που εμφανίζονται επάνω στο προϊόν ή στα εγχειρίδια που το συνοδεύουν, υποδεικνύουν ότι δεν θα πρέπει να ρίπτεται μαζί με τα υπόλοιπα οικιακά απορρίμματα μετά το τέλος του κύκλου ζωής του. Προκειμένου να αποφευχθούν ενδεχόμενες βλαβερές συνέπειες στο περιβάλλον ή την υγεία εξαιτίας της ανεξέλεγκτης διάθεσης απορριμμάτων, σας παρακαλούμε να το διαχωρίσετε από άλλους τύπους απορριμμάτων και να το ανακυκλώσετε, ώστε να βοηθήσετε στην βιώσιμη επαναχρησιμοποίηση των υλικών πόρων.

Οι επιχειρήσεις-χρήστες θα πρέπει να έλθουν σε επαφή με τον προμηθευτή τους και να ελέγξουν τους όρους και τις προϋποθέσεις του συμβολαίου πώλησης. Το προϊόν αυτό δεν θα πρέπει να αναμειγνύεται με άλλα συνηθισμένα απορρίμματα προς διάθεση.

Germany

**Korrekte Entsorgung dieses Produkts
(Elektromüll) - Nur Europa**



Anzuwenden in den Ländern der Europäischen Union und anderen europäischen Ländern mit einem separaten Sammelsystem) Die Kennzeichnung auf dem Produkt bzw. auf der dazugehörigen Literatur gibt an, dass es nach seiner Lebensdauer nicht zusammen mit dem normalen Haushaltsmüll entsorgt werden darf. Entsorgen Sie dieses Gerät bitte getrennt von anderen Abfällen, um der Umwelt bzw. der menschlichen Gesundheit nicht durch unkontrollierte Müllbeseitigung zu schaden. Recyceln Sie das Gerät, um die nachhaltige Wiederverwertung von stofflichen Ressourcen zu fördern.

Gewerbliche Nutzer sollten sich an Ihren Lieferanten wenden und die Bedingungen des Kaufvertrags konsultieren. Dieses Produkt darf nicht zusammen mit anderem Gewerbemüll entsorgt werden.

Denmark

**Korrekt affaldsbortskaffelse af dette produkt
(elektrisk & elektronisk udstyr) - Kun Europa**



Mærket på dette produkt eller i den medfølgende dokumentation betyder, at produktet ikke må bortskaffes sammen med almindeligt husholdningsaffald efter endt levetid. For at undgå skadelige miljø- eller sundhedspåvirkninger på grund af ukontrolleret affaldsbortskaffelse skal dette produkt bortskaffes særskilt fra andet affald og indleveres behørigt til fremme for bæredygtigt materiale genvinning.

Erhvervsbrugere bedes kontakte leverandøren og læse betingelserne og vilkårene i købekontrakten. Dette produkt bør ikke bortskaffes sammen med andet erhvervsaffald.

Czecho-slovakia

**Správná likvidace tohoto produktu
(Zničení elektrického a elektronického zařízení) - Pouze Evropa**



Tato značka zobrazená na produktu nebo v dokumentaci znamená, že by neměl být používán s jinými domácími zařízeními po skončení svého funkčního období. Aby se zabránilo možnému znečištění životního prostředí nebo zranění člověka díky nekontrolovanému zničení, oddělte je prosíme od dalších typů odpadů a recyklujte je zodpovědně k podpoře opětovného využití hmotných zdrojů.

Obchodníci by měli kontaktovat své dodavatele a zkontrolovat všechny podmínky koupě. Tento výrobek by se neměl míchat s jinými komerčními produkty, určenými k likvidaci.

The information contained herein is to the best of our knowledge accurate and complete. However cell species and cell environments may vary in property. Therefore systematic and/or random deviation between estimates obtained by the NucleoCounter[®] and other cell counting methods may occur. As such, nothing contained or stated herein including results obtained from use of the NucleoCounter[®] or NucleoCassette[™] shall be construed to imply any warranty or guarantee. ChemoMetec A/S and affiliated companies shall not be held liable for damages and customers shall indemnify ChemoMetec A/S and affiliated companies against liability flowing from use of potentially inaccurate data generated by the NucleoCounter[®]. It is recommended that all results obtained with the NucleoCounter[®] are validated against appropriate reference methods and/or traditional laboratory methods at regular intervals.