

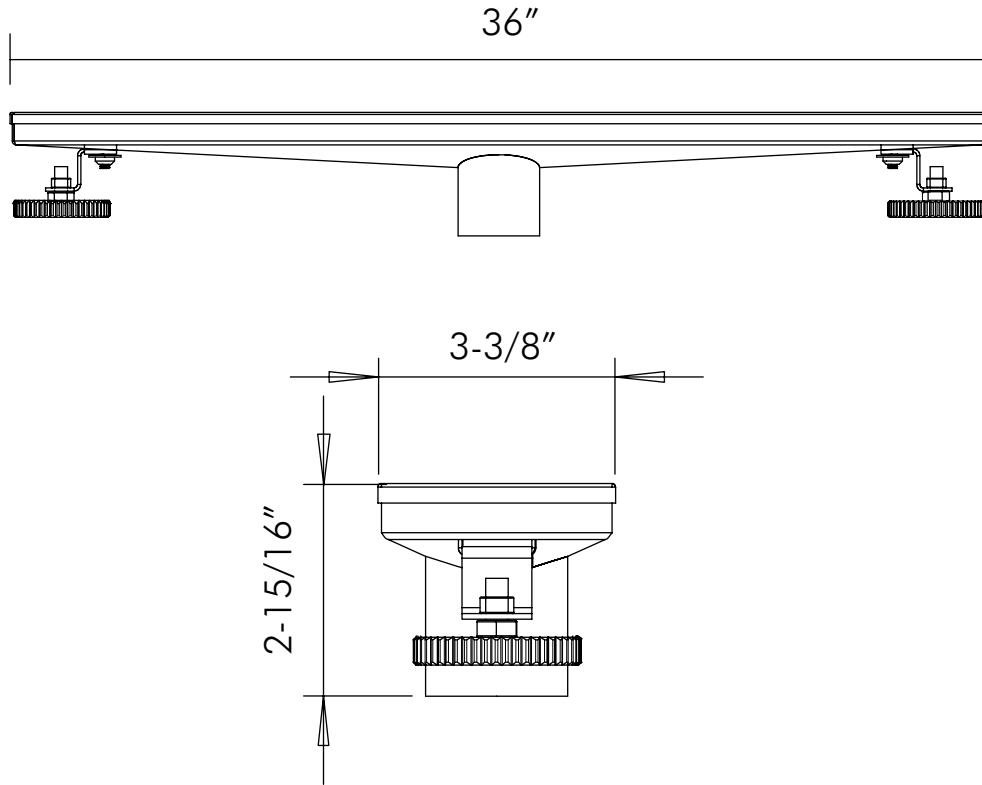

DR36-H01



DRAIN SYSTEMS **SERIES**



FEATURES

- Stainless steel body
- Brushed stainless steel finish



DRAIN SYSTEMS **DR36-H01**

MODEL	DR36-H01
MATERIAL	STAINLESS STEEL
WIDTH	36"
HEIGHT	3-3/8"
DEPTH	2-15/16"
OUTSIDE OUTLET DIAMETER	2"
CUPC	YES
FLOW CAPABILITY	65L/MIN
FINISH	Brushed stainless steel